

## **Historic, Archive Document**

Do not assume content reflects current scientific knowledge, policies, or practices.



62.61

U.S. DEPARTMENT OF AGRICULTURE  
BUREAU OF PLANT INDUSTRY  
WASHINGTON, D. C.

# MARSHALL'S

*Matchless*

# SEEDS



1937

**W. E. MARSHALL & CO. *Inc.***  
150 West Twenty Third Street  
**NEW YORK CITY**

# INFORMATION *and* INSTRUCTIONS

**A** GARDENING catalogue, that is really representative of the choicest and best products in the various departments of Horticulture, requires a tremendous effort on the part of those who assist in its preparation, for it is apparent that it cannot be the work of one individual. The mere printing and illustrating is nothing as compared with the work involved in the preparation of the text. An organization such as ours, where each department is managed by a capably trained and efficient executive, must show continual progress all along the line through its offerings to the gardening public, in order to maintain its well-established reputation as a reliable and responsible institution.

We aim to keep all our departments up to date. We include those items that show merit over older but similar types, which are discarded. Whether it be a flower, vegetable or plant, each is given its true interpretation in color, size, character and general utility.

Research in Lilies alone has brought us in contact with some 110 or 115 varieties gathered in the distant regions of every continent in the world; these have been carefully classified, described and illustrated and are offered to our American friends, in such a comprehensive form, that the merest amateur can have lilies in his garden that were previously unheard of. Many

of them are listed in this catalogue, but complete descriptions are given in our book "Consider the Lilies" devoted to Lilies exclusively (see page 62).

We invite inquiries from those seeking advice on Horticulture as we have in our establishment experts who are well qualified to impart information. It may be possible that there are many articles not enumerated in our comprehensive list but as we have extensive sources of supply an inquiry will bring the desired information and lowest quotation on high grade stock.

W. E. MARSHALL & CO. INC.

**ORDER EARLY.** We request our customers to order as early as possible on receipt of catalogue. We endeavor to ship all orders immediately on receipt, but during the busy season it is almost impossible; hence, the importance of ordering early.

Orders for Bulbs, Plants and Nursery Stock will be shipped in due time for planting in season.

**PARCELS POST.** We deliver free by Parcels Post all seeds, when cash accompanies the order, except Farm Seeds or Clovers. If these are wanted by mail, please add the cost of postage at zone rates.

Fertilizers, insecticides, sundries, trees and plants are, at all times, except as stated below, excluded from free delivery.

No charge for delivery to railroad station, steamer or express office.

**DELIVERY.** We deliver free by Parcels Post, Express or Freight (at our option) all Fertilizers, Insecticides or Garden Sundries on all orders value \$3.00 or over, when cash accompanies the order, within a radius of 50 miles of New York City.

**ESTATE SUPERINTENDENTS, GARDENERS AND FARMERS.** Persons requiring the services of reliable men, married or single, should consult with us, as we have the names of a number on our register, thoroughly experienced in every branch of the business. There is no charge for this service.

**TREES AND SHRUBS.** We are not listing them in this catalogue but will gladly quote prices on any quantity or variety. As we have an excellent source of supply we are in a position to give estimates on plantings where first class stock is wanted. By letting us estimate on your planting requirements you incur no obligation whatever.

**PRICES.** The prices published in this catalogue are subject to market changes without notice. Owing to the fluctuating market in prices of all materials, we cannot bind ourselves on prices of any articles.

**PAYMENT.** All orders should be accompanied by cash in the form of Draft, Cheque or P. O. Order. Owing to the difficulty in collecting accounts, no order from parties unknown to us or whose accounts remain unsettled will be attended to unless accompanied by remittance.

**C. O. D. SHIPMENTS.** We are always pleased to supply seeds to be paid for on delivery. Bulbs, Plants, Fertilizers, Insecticides and Perishable Stock will not be sent C. O. D. unless 50 per cent cash accompanies the order.

## WE ISSUE THE FOLLOWING CATALOGUES AND SPECIAL LISTS

**BULB CATALOGUE.** Ready about July 1st, containing a complete list of all bulbs for Fall planting and greenhouse forcing.

**LILIES.** A complete list of over 100 varieties described and illustrated. (See page 63).

**TRAINED FRUIT TREES.** Illustrated folder and cultural instructions.

## IMPORTANT DATES FOR 1937

**Easter Sunday.** March 28th.

**Decoration Day.** May 30th.

**Mather's Day.** May 9th.

**Thanksgiving Day.** November 25th.

# W. E. MARSHALL & CO., Inc.

150 WEST 23rd STREET

NEW YORK

TELEPHONES:

CHELSEA 3-3287, 3-3288.

**LOCATION OF OUR STORE**  
Our store, No. 150 West 23rd Street, is situated between Sixth and Seventh Avenues.

Index (See Page 96)



# Marshall's Lawn Grass Seeds

Marshall's Lawn Grass Seeds have given universal satisfaction for the past 33 years and are used on many of the largest estates in every section of the country for making the best lawns. Our mixtures contain only the best grades of re-cleaned grasses blended in proportions to give quick and permanent results.

## MARSHALL'S "Durogreen" LAWN GRASS

Marshall's Durogreen Lawn Grass Mixture (formerly called **Special Lawn Grass**) produces a perfect as well as permanent lawn of luxuriant richness. It quickly forms a closely interwoven, firm and elastic turf ready for cutting in about 6 weeks from time of sowing. Durogreen mixture is the result of years of experimenting and is composed of the proper proportions of fine-leaved, deep rooting, perennial grasses which will thrive under varied conditions of soil and climate; maintaining a succession

of growth during the different seasons of the year, thus insuring a rich, deep green, smooth and velvety lawn, free from clumps. This is a scientifically blended mixture, containing only the highest grade of re-cleaned seeds of Red Top, Kentucky Blue, Chewing's Fescue and Colonial Bent grasses, blended in proper quantities. **Price: Lb. 65c; 5 lbs. \$3.00; 20 lbs. \$11.00; 100 lbs. \$55.00.** Delivered transportation paid when cash accompanies the order.

## MARSHALL'S "Matchless" LAWN GRASS

Marshall's Matchless Lawn Grass Mixture (formerly called **Central Park**) still maintains a high place in the esteem of those who desire an even, dense growth of permanent sward very early in the season. This mixture contains no annual grasses so detrimental to a permanently good lawn. Only grasses of lasting value and extreme hardness are used in this popular mixture and we exercise great care to use only the purest seed in the proper proportions in its blending. This mixture is recommended to those who desire a popular priced mixture for average conditions and requirements.

Our Matchless Lawn Mixture is prepared from our own formula and must not be confused with many mixtures that are sold under this name. It is composed of only the best re-cleaned seeds, containing Kentucky Blue, Fancy Red Top, Fescue, Perennial Rye and a small quantity of White Clover, all blended to warrant perfect results.

1 lb. will sow a plot 15x15 ft.; 3½ lbs., 25x40 ft. (1,000 sq. ft.); 150 lbs., 1 acre (43,565 sq. ft.). **Price: Lb. 45c, 5 lbs. \$2.15, 20 lbs. \$8.00, 100 lbs. \$40.00.**

## MARSHALL'S "SHADY PLACE" LAWN GRASS

Usually it is quite difficult to obtain a satisfactory growth of grass under trees and in shady places; for sowing in such places we recommend the use of this special mixture. It will quickly produce an abundant and even growth of beautiful green grass. The grasses

used in making this special mixture are only those adapted for growing in shade. It has been successfully used on some large operations where a green sward was desired on land partially shaded by old trees. **Price: Lb. 60c, 5 lbs. \$3.00, bu. (20 lbs.) \$11.00, 100 lbs. \$55.00.**

Delivered transportation prepaid when cash accompanies the order.

For best results use **Marshall's Lawn Dressing** for new and old lawns.  
**The Lawn.** The latest and best knowledge on the making and upkeep of lawns. By L. S. Dickinson. \$1.25, Postpaid.

For **Beetle Grubs in Lawns** use 15 lbs. Magnesium Arsenate for each 1000 feet of space. Apply in September mixing it with sand.

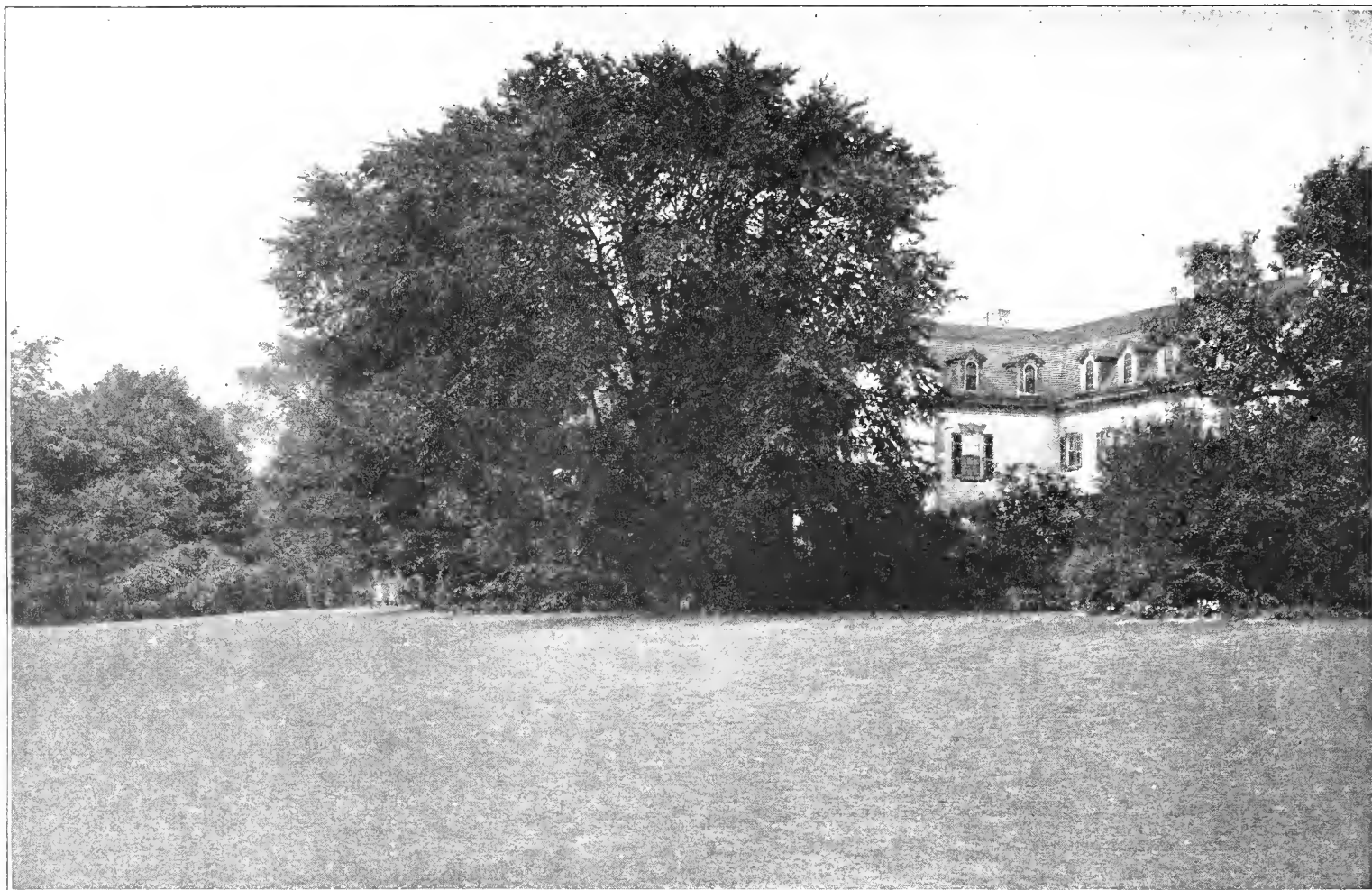

**MARSHALL'S  
ALL BENT FORMULA  
LAWN GRASS**

For many years Bent Grasses have been used for Putting Greens with great popularity and recently many are using them for lawns with perfect results. Our mixture contains only Bent Grasses in variety. One pound will sow a plot 10x20 ft., 150 lbs. 1 acre. **Price:** Lb. \$1.70, 5 lbs. \$8.00, 20 lbs. \$30.00.

**MARSHALL'S  
"TERRACE"  
LAWN GRASS**

A special mixture of grasses for sowing on terraces and side hills—grasses that produce strong, spreading roots, thus preventing heavy rain from washing them out; that will withstand drought and exposure, thrive on shallow soils and produce a rich, green turf throughout the season. **Price:** Lb. 75c, 5 lbs. \$3.65, bu. (20 lbs.) \$14.00, 100 lbs. \$70.00.

**MARSHALL'S  
CHEWING'S FESCUE  
FORMULA  
LAWN GRASS**

To procure an exceptionally fine lawn that will withstand drought and other adverse conditions, we recommend this mixture. It is composed of Chewing's Fescue, various Bents and a small proportion of Red Top. These grasses will give a wonderful dark green texture and combined with their spreading habit and thick growth will give a velvety appearance throughout the Summer and Fall. **Price:** Lb. 90c, 5 lbs. \$4.35, 20 lbs. \$17.00.

**SPECIAL LAWN GRASS MIXTURE FOR  
SEASIDE LAWNS**

A mixture of fine grasses peculiarly suited to seaside lawns and very sandy soils. **Price:** Lb. 75c, 5 lbs. \$3.65, bu. (20 lbs.) \$14.00, 100 lbs. \$70.00.

**SPECIAL LAWN GRASS FORMULAS**

The following formulas are recommended by the New Jersey Experiment Station, New Brunswick, N. J., for lawns under various conditions.

**Formula No. 1. Standard Mixture.** Without Clover. For lawns on good soils. Per lb. 50c, 10 lbs. \$4.75.

**Formula No. 1. Standard Mixture.** With Clover. For lawns on good soils. Per lb. 45c, 10 lbs. \$4.50.

**Formula No. 2. Finest Quality Turf Mixture.** For finest lawns. Per lb. 75c, 10 lbs. \$7.00.

**Formula No. 3. Shaded Area Mixture.** For shady places on lawns. Per lb. 70c, 10 lbs. \$7.00.

**Formula No. 4. Mixture For Terraces, Clayey and Sandy Soils.** Per lb. 70c, 10 lbs. \$7.00.

DELIVERED TRANSPORTATION PAID, WHEN CASH ACCOMPANIES THE ORDER, WITHIN A RADIUS OF 150 MILES OF NEW YORK.

# Marshall's Grass Mixtures for Golf Links

## MARSHALL'S "PUTTING GREEN," or "TENNIS COURT" MIXTURE

A very carefully prepared mixture for use on putting greens, croquet lawns, tennis courts, bowling greens and lawns. This mixture produces a very thick, soft growth; when sown on a well-prepared ground, and mowed short will allow a ball to roll in almost a direct line. We especially recommend this mixture to those who are particular to obtain the very best. Our mixture contains only the very fine-bladed species of grasses without Rye Grass. 25 lbs. will seed a putting green 75 feet square. **Price: 5 lbs. \$4.50, 20 lbs. \$16.00, 100 lbs. \$75.00.**

## MARSHALL'S FAIR GREEN MIXTURE

Marshall's Fair Green Mixture is composed mainly of perennial native grasses and two very important European grasses which have proven of great value for Fair Green use. They are all of dwarf, spreading growth, forming a close velvety surface which improves from year to year if given proper care.

This mixture contains no Clover but will be added if desired in quantity of one-half pound per bushel of gross seed. Sow 150 lbs. per acre. **Price: 20 lbs. \$10.00, 100 lbs. \$50.00.**

## MARSHALL'S POLO FIELD MIXTURE

This mixture is composed of deep rooting grasses that will form an enduring turf and stand the roughest usage. Sow at the rate of 150 to 200 lbs. per acre. **Price: 25 lbs. \$15.00, 100 lbs. \$60.00.**



## Grass for Hay Crops and Pastures

### Mixtures for Hay and Permanent Pastures

The results obtained from our special Grass Seed mixtures are well known by the constantly increasing demand for them. Fall seeding is preferable, but spring sowing will be successful if done early, while the land is cool and moist. In addition to the Grasses, we advise sowing 10 lbs. of Mixed Clover Seed per acre.

**We recommend sowing 50 lbs. to the acre.**

**Permanent Pasture Mixture No. 1.** For cool and light soils.

**Permanent Pasture Mixture No. 2.** For medium soils.

**Permanent Pasture Mixture No. 3.** For heavy soils.

Prices of any of the above Mixtures, 10 lbs. \$4.00, 100 lbs. \$35.00.

# Marshall's Recleaned Grass Seeds

## FOR LAWNS, FIELD AND OTHER PURPOSES

Many of the following grasses are used in Mixtures for Lawns and Pastures. The seeds we are offering show maximum purity and germination and are all of the highest quality procurable.

For anyone wishing mixtures of their own formula, we shall be pleased to ship the grasses separate or mix them to their own specifications.

	Lb.	10 lbs.	100 lbs.
<b>Bent, Cacaas or Seaside Bent.</b> A hardy creeping variety with fine texture and a beautiful dark green color. It has fine turf producing qualities for Putting Greens or Lawns. ....	\$1.30	\$12.00	\$120.00
<b>Bent, Colonial</b> ( <i>Agrostis tenuis</i> ). Identical to Rhode Island Bent .....	1.10	10.00	100.00
<b>Bent, Creeping</b> ( <i>Agrostis</i> Species or South German). One of the finest grasses for Putting Greens and Lawns. Makes a low, compact velvety growth with spreading habit. ....	1.70	16.00	160.00
<b>Bent, Rhade Island</b> ( <i>Agrostis tenuis</i> ). Makes a fine dark green turf, of good color and fine texture .....	1.10	10.00	100.00
<b>Blue Grass, Canadian</b> ( <i>Poa compressa</i> ). Adapted to the poorest and driest soils. Fine for pastures but not suited for lawns owing to its less pleasing color .....	.50	3.50	35.00
<b>Blue Grass, Kentucky</b> ( <i>Poa pratensis</i> ). One of the most valuable native grasses for lawns and pastures. Succeeds well on all good soils. Weight per bu. 20 lbs. ....	.50	4.00	40.00
<b>Fescue, Chewing's New Zealand.</b> Adapted to practically all conditions, making a fine compact turf of dark green color and resistant to hard wear. Weight per bu. 20 lbs. ....	.60	5.50	55.00
<b>Fescue, Hard</b> ( <i>Festuca duriuscula</i> ). A slender, densely tufted perennial grass, 1 to 2 ft. high. Thrives on dry, sandy soils. Weight per bu. 14 lbs. ....	.70	6.50	60.00
<b>Fescue, Red</b> ( <i>Festuca rubra</i> ). A deep rooting grass suitable for lawns in poor and sandy soils. It resists drought and will thrive in shady places .....	.70	6.50	60.00
<b>Fescue, Sheep</b> ( <i>Festuca ovina</i> ). A small tufted, hardy grass, of value in mixture for lawns or dry soil .....	.70	6.50	60.00
<b>Fescue, Meadow, or English Blue Grass</b> ( <i>Festuca pratensis</i> ). Root creeping; perennial; flowers in July; one of the most valuable of the Fescue grasses. This grass is well adapted for permanent pastures. It should always be mixed with other grasses .....	.30	2.25	25.00

	Lb.	10 lbs.	100 lbs.
<b>Orchard Grass.</b> A good grass for hay crop, yielding nearly the same amount as Timothy and almost equal in feeding value. Orchard Grass will grow on almost every soil. One of the best grasses for sowing in shady places and among fruit trees in orchards. 35 to 40 lbs. required for one acre. Weight per bu. 14 lbs. ....	\$.035	\$3.00	\$29.00
<b>Red Top, Fancy Cleaned</b> ( <i>Agrostis vulgaris</i> ). A highly recommended grass for permanent pasture and as meadow grass for hay. Red Top is especially valuable for sour and acid soils, and meadow lands. Red Top makes one of the best grasses for lawn use, either sown alone or in connection with White Clover, or in a mixture with other grasses. Use 14 to 16 lbs. to acre. Weight per bu. 30 lbs. ....	.50	4.50	40.00
<b>Rye Grass, Domestic.</b> A mixture of English and Italian Rye Grasses, grown in the United States, and used for a nurse for lawn grasses and where immediate results are wanted. Extensively used in the South for turf .....	.25	1.50	14.00
<b>Rye Grass, Italian</b> ( <i>Lolium italicum</i> ). It is a very rapid grower, forms a dense turf, and is regarded as an excellent hay grass. Weight per bu. 20 lbs. ....	.25	2.00	20.00
<b>Rye Grass (Pacey's).</b> A carefully selected, short-seeded, dwarf-growing strain, suitable for lawns .....	.30	2.50	25.00
<b>Rough Stalked Meadow Grass</b> ( <i>Poa trivialis</i> ). A spreading, stoloniferous rooted grass. Adapted for shady lawns and pasture mixtures ..	.60	5.50	55.00
<b>Timothy, or Herd Grass.</b> ( <i>Phleum pratense</i> ). The standard hay of commerce. The excellent quality of the hay and the ease of culture make it valuable. It is adapted to moist soils, but succeeds best on moist loam and clay. Timothy sown alone requires about 20 lbs. per acre; when sown with Red Clover use 15 lbs. Timothy and 5 lbs. Red Clover. Weight per bu. 45 lbs. ....	.20	1.60	16.00
<b>Wood Meadow Grass</b> ( <i>Poa nemoralis</i> ). Excellent for shaded positions in lawns and woodland parks. Very hardy, resisting extremes of heat and cold .....			Market price

Prices subject to market changes.

## CLOVERS

Prices subject to market changes.

	Quantity per acre	Per lb.	Per 10 lbs.	Per 100 lbs.
<b>Alfalfa, or Lucerne</b> ( <i>Medicago sativa</i> ). Northwestern Pine Tree One of the most valuable forage plants .....	20 lbs.	\$0.55	\$5.00	\$50.00
<b>Alfalfa, Grimm.</b> Certified. This strain has larger crowns and a deeper root system, is extremely hardy and more productive than the ordinary variety .....	20 lbs.	.65	6.00	60.00
<b>Alsike</b> ( <i>Trifolium hybridum</i> ). The hardiest of all Clovers, can be cut several times in one season. Grows well on low, wet land.....	10 lbs.	.45	4.25	45.00
<b>Crimson, or Scarlet Clover</b> ( <i>Trifolium incarnatum</i> ). An annual variety producing large crops of green foliage .....	20 lbs.	.20		25.00
<b>Mammoth Red, or Pea Vine.</b> Grows much taller than Medium Red Clover .....	10 lbs.	\$0.65	\$6.00	\$60.00
<b>Medium Red</b> ( <i>Trifolium pratense</i> ). Domestic. This is the common Red Clover so largely grown throughout the country .....	15 lbs.	.60	5.50	55.00
<b>Sweet Clover, Bokhara</b> ( <i>Melilotus alba</i> ). Will grow on very poor soils; useful for ensilage and plowing under. Grows from 3 to 4 ft. high. Hulled seed .....	15 lbs.	.25	2.25	20.00
<b>White Clover</b> ( <i>Trifolium repens</i> ). Valuable for lawns as it forms a very close and green texture. On sandy dry soils it is very satisfactory. It is also valuable in pastures ..	10 lbs.	.65	6.25	60.00
<b>Mixed Clover</b> .....	10 lbs.	.55	5.30	52.50

All Clovers weigh 60 pounds per bushel.

Inoculate this seed with **LEGUME CULTURES** "Legume Cultures," "Stimugerm" for Alfalfa and Clovers. 1/2-bu. unit, 30c. 1-bu. unit, 60c. 2 1/2-bu. unit, \$1.25.



# Novelties and Specialties in Flower Seeds

## AQUILEGIA CLEMATIFLORA, MIXED

This new spurless Aquilegia which was obtained by a cross between Scott Elliott strain and the common single variety, we feel will be a useful addition to the varieties now offered.

This cross has been selected for eight years and the colors are all there with the exception of reds and scarlets. It is free flowering, having as many as fifteen flowers, measuring three inches across, on a plant. Per packet, 75c.

## RUST-PROOF ANTIRRHINUM MAXIMUM

With the introduction of rust-proof strain of Antirrhinums which contains 75% of rust-proof plants we feel that their popularity, which has always been held back by rust, will increase and make Antirrhinums one of the most popular flowers in America. 2½ to 3 ft.

**Alosko.** Large pure white.

**Campfire.** A new color in Antirrhinums, being pure luminous scarlet.

**Canary Bird.** Canary-yellow, vigorous.

**Copper Shades.** An outstanding variety due to the range of shades present.

**Crimson.** A magnificent rust-proof type.

**Fairy Lady.** A beautiful shade of silver-pink.

**Loveliness.** Pure soft rose-pink.

**Rust-Proof Mixed.** Contains a wonderful range of popular colors.

Named varieties, 35c per packet. Mixed, 25c per packet.

**Rust-Proof nonum grandiflorum Mixed.** Excellent for bedding. The color range, size of flower and habit are most remarkable. 18 inches. Packet, 25c.

## CANTERBURY BELLS, DWARF BEDDING

A new dwarf, compact type only about 20 inches in height, forming bushes over 3 feet in circumference. The plants are wonderfully floriferous and will make a splendid subject for spring bedding. Shades of blue, white and mauve in mixture. Packet, 50c.

## CHRYSANTHEMUMS, HARDY GARDEN KOREAN HYBRIDS

These single perennial Chrysanthemums produce a lavish profusion of colorful blooms just at a time when other plants are beginning to fail. The bushy plants are hardy, easy to grow, and if sown early will bloom in the late fall of the same year as sown.

The range of colors is most impressive. Packet, \$1.50.

## CHRYSANTHEMUM CORONARIUM SINGLE GOLDEN GLORY

Large, perfectly formed flowers, three to four inches across, of deep canary-yellow petals and disc of same color. Flowers are produced on two-foot stems on plants growing three feet high. This annual Chrysanthemum, which is very free flowering and makes an ideal cut flower, should find favor with everyone. Per packet, 25c.



Cotyledon Simplicifolia

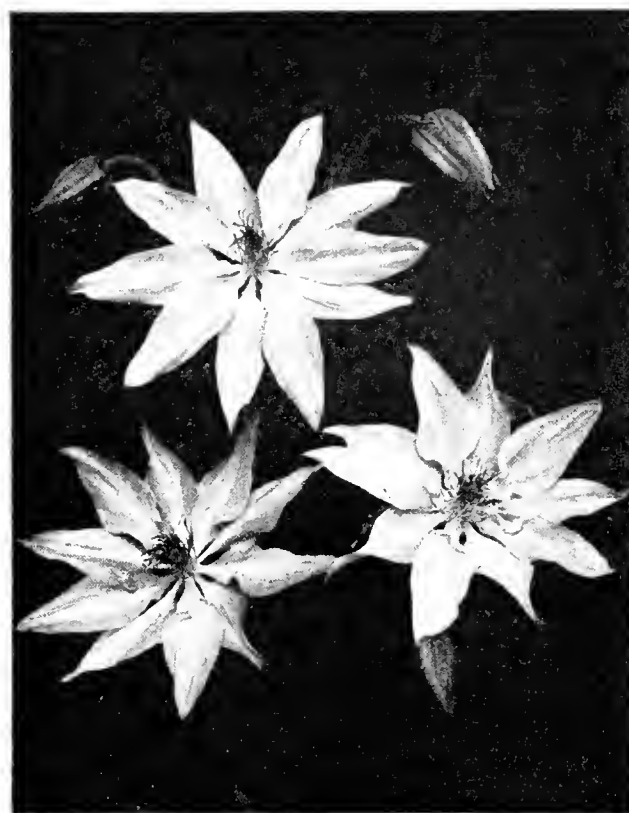

Aquilegio Clemotifloro

## CHEIRANTHUS ALLIONI, GOLDEN BEDDER

Gardeners throughout the country will welcome Cheiranthus Golden Bedder as an alternative to the orange form. The color is a deep golden-yellow. Its fine tone will blend more easily with many subjects than does that of Allioni.

It is a sweetly scented, long-lasting flower, especially if the seed pods are not allowed to form. Packet, 50 cents.

## CORNFLOWER, JUBILEE GEM

Jubilee Gem is a dwarf variety of Cornflower making a compact plant literally covered with flowers. It has foliage distinct from all other Cornflowers, forming a tufted mass of vivid green, contrasting well with the dark but vivid double blue flowers. The plant is about 12 inches in height. Packet, 15c; ¼ oz., 75c.

## COSMOS, KLONDYKE ORANGE FLARE

Until the introduction of this early flowering strain, the brilliant orange Cosmos has been practically unknown in most parts of the country because of its late flowering habit. Orange Flare is a strain which is in full bloom less than five months from sowing. The color is the same vivid orange as the ordinary Klondyke with attractive light green foliage. 2½ to 3 feet. Packet, 15c; ¼ oz., 75c.

## COSMOS, SENSATION MIXED

This extremely early Cosmos, for the short time it has been on the market, has earned for itself a permanent position in the garden world. The flowers have heavy, fluted petals and are mammoth in size. Colors white and shades of rose and pink. Height about 4 feet. Packet, 25c; ¼ oz., \$1.00.

## COTYLEDON SIMPLICIFOLIA

A gem for the rockery, with spikes of small, golden yellow bells which hang down over sedum-like foliage. This hardy perennial should be planted in a sunny situation. Grows 6 to 8 inches high and flowers in June and July. Packet, 50c.

FLOWER SEED SPECIALTIES—Continued.

**GAILLARDIA GRANDIFLORA, GOBLIN**

This dwarf Gaillardia forms 12- to 16-inch broad, arched plants, of close, compact habit. The foliage is practically covered with two-colored flowers of bright yellow with a deep red zone. Flower stalks are long enough to provide lasting cutting material from July till October. If sown in early spring, this perennial Gaillardia will flower the same year. Pkt., 50c.



Gaillardia, Goblin

**LARKSPUR, GIANT IMPERIAL WHITE KING**

The flowers are a pure glistening white on heavy hollyhock-like, cutting spikes from 24 to 30 inches long. Single florets are extremely large and fully double. Plants are upright in habit, 4 to 5 feet high. Pkt., 50c; 1/4 oz., \$3.00.

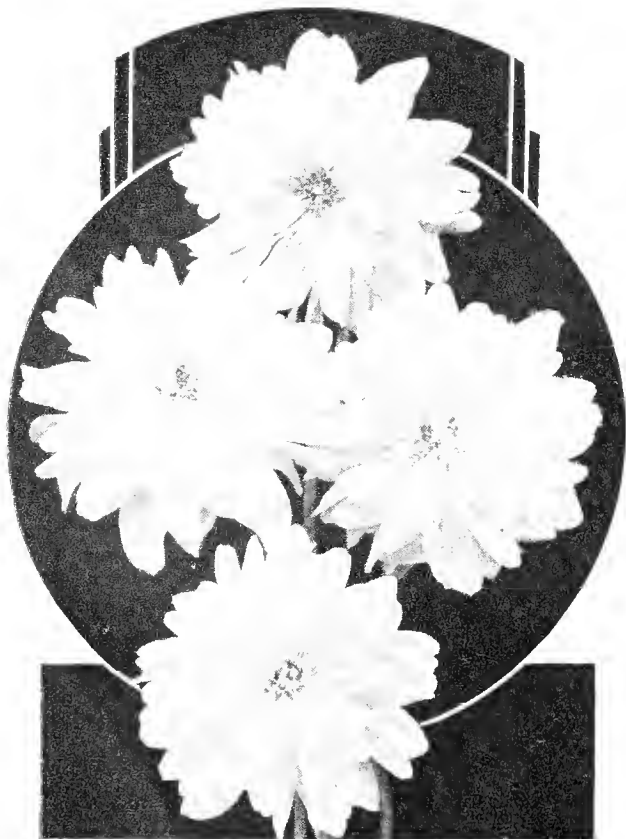

Leptosyne, Golden Rosette

**LEPTOSYNE, GOLDEN ROSETTE**

This bright butter-yellow, double form of Leptosyne Stillmani is of easy culture and will succeed almost anywhere. As a cut flower it will be found admirable and it is difficult to think of its equal in "yellow annuals." Height 18 inches. Pkt., 50c.



Marigold, Harmony

**MARIGOLD, HARMONY**

This striking new variety that has already proven its worth is a remarkable break in the dwarf French section of Marigolds. The double flowers almost suggest those of a Scabious and are of a bright golden yellow, bordered with rich maroon-red. The plants are bushy and about 12 inches high. "Harmony" comes quite true from seed. Pkt., 25c; 1/4 oz., \$1.00.

**MARIGOLD, CROWN OF GOLD**

An entirely new type of Marigold. The crown and the collarette of big broad petals are of a bright, clear golden orange. The flowers are slightly sweet scented and the foliage is free of the usual Marigold odor. Early flowering and very floriferous. Height 1 foot. Pkt., 50c.

**MARIGOLD GIGANTEA, SUNSET GIANTS**

Flowers of this variety are the largest ever known in the Marigold group and are produced in great profusion. They are loosely formed, very full centered with broad, heavy petals. Sunset Giants is a mixture comprising almost every shade of yellow from golden orange to pale primrose. The plants grow about 3 1/2 feet high and are extremely strong growing. Pkt., 50c.

**LIEB'S WINTER-MARIGOLD**

Mahogany-brown with golden yellow crested center. Blossoms 3 inches in diameter, of wonderful keeping quality.

With 2 1/4-inch stock planted during September or October cut flowers can be had in December and continue well into May. The plants are at their best during January and February when cut flowers are not too plentiful.

Seed, 50c per packet. Plants, 2 1/4-inch, \$12.00 per 100.

**NASTURTIUM, DWARF DOUBLE GOLDEN GLOBE**

The plants are truly dwarf and compact, totally without runners. They are very free flowering and the well formed double flowers of deep golden yellow are delicately sweet scented. We feel sure that this compact variety will be even more popular than the Golden Gleam. Pkt., 25c; oz., 75c.

Flower Seed Specialties—Continued.

**GILIA LINIFLORA WHITE SWAN AND BUNCH OF LILAC**

Introducing a new subject for cut flower use, *Gilia Liniflora*, a very easily grown, attractive annual. The plants are neat, upright and semi-compact in habit, 12 to 15 inches high, covered with dozens of the dainty, single flax-like flowers which are borne on long stems. White Swan is snowy white, and Bunch of Lilac a clear lavender-blue. Per packet 35c each; 1/4 oz., \$1.00.

**MARSHALL'S NEW ORNAMENTAL PEPPER**

An excellent plant for Fall and Christmas decoration. It has been pronounced by growers, who have tried this Pepper for us, as far superior and more ornamental than varieties previously grown. Plants are compact, about 6 to 9 inches high, with good, deep green, heavy foliage and are literally covered with small oval fruits in shades of purple, red and white, and brilliant scarlet. 50c per packet.

**PETUNIA GRANDIFLORA. SINGLE FRINGED DAINTY LADY**

Dainty Lady, the new yellow *Petunia*, has occasioned favorable comment wherever grown. The flowers are of medium size and are fringed, delicate light yellow deepening to golden yellow at the throat. The plants are compact, somewhat upright in habit, semi-dwarf and very free flowering. Packet, 50c.

**RANUNCULUS MARSHALL'S SUPER HYBRIDS**

We have made arrangements with a prominent New Zealand grower who has been supplying this wonderful strain of *Ranunculus* that has been taking the first award at the International Flower Show in New York.

Fresh seeds will arrive here in March and may then be sown in greenhouse, these plants would bloom the following Spring, a selection can then be made for bulbs with the finest flowers to be used for exhibition purposes the following season.

This is the finest strain that has been placed on the market. \$1.00 per packet; 6 packets for \$5.00.

**VISCARIA, BLUE PEARL**

*Viscarias* are becoming extremely popular and this new shade is a valuable addition to these attractive annuals. The color, clear lavender-blue, is outstanding and the absence of an "eye" which is common to most sorts, adds considerably to its distinction. Makes a very attractive effect en masse. Packet, 35c.



Zinnia, Scabiosa-Flowered

**ZINNIA. SCABIOUS-FLOWERED AUTUMN TINTS MIXED**

This strain which has been named "Autumn Tints" is perfect in form of flower and comes true. The real beauty, however, is in the lovely coloring of the flowers which range through all the gorgeous autumn foliage tints. The colors include orange, bronze, russet, dull red, carnation-red, terra cotta and intermediate shades. Packet, 35c; 1/4 oz., \$1.00.

**NEW AND DISTINCTIVE PLANTS & BULBS**

**ANGELONIA SALICARIAEFOLIA**

A most fascinating tender perennial which may be used as a pot plant, but experience has proven it to be a most desirable bedding plant. It will bloom consistently throughout the season, will endure excessive drought and, on the other hand, has withstood heavy rain storms. The plant is well branched and festooned with *Glaxinia*-like blossoms of purplish blue with white throats. Will bloom its best when grown in poor soil. Plants from 2 1/2-inch pots, \$3.00 per doz.; \$25.00 per 100.

**HARDY ASTERS**

(Michaelmas Daisies)

**Frikarti** (Wonder of Staefa). Large flowers of a Wisteria-violet shade with large yellow centers. This Aster has a longer blooming period than any other variety, flowering from late August to frost. Height 2 to 2 1/2 feet. Pot plants only. Three for \$1.50; \$4.50 for ten.

**New Dwarf Hybrid Border Asters**

We highly recommend these new Dwarf Hybrid Border Asters, as they fill a distinct need for a dwarf, compact, free flowering plant that will make a showy display during the weeks just preceding the blooming of the earliest *Chrysanthemums*.

**Constance.** Light pink. 12 to 15 inches high.

**Diana.** Blush-pink. 15 inches.

**Hebe.** Clear lavender-blue. 15 inches.

**Lavanda.** A lovely pure light blue. 12 inches.

**Lilac Time.** Deep lilac-blue. 15 inches.

**Niobe.** Pure white. Very compact. 12 inches.

Any of the above, 3-inch pots: 3 for \$1.00; \$3.50 per doz.

**New Spring-Flowering Dwarf Asters**

**Star of Wartburg.** 1 foot. Large flowers on strong, erect stems. Makes a fine display with its dark lilac-blue flowers with orange center. 3 for \$1.50; \$5.00 per doz.



Aster, Star of Wartburg

NEW AND DISTINCTIVE PLANTS AND BULBS—Continued.

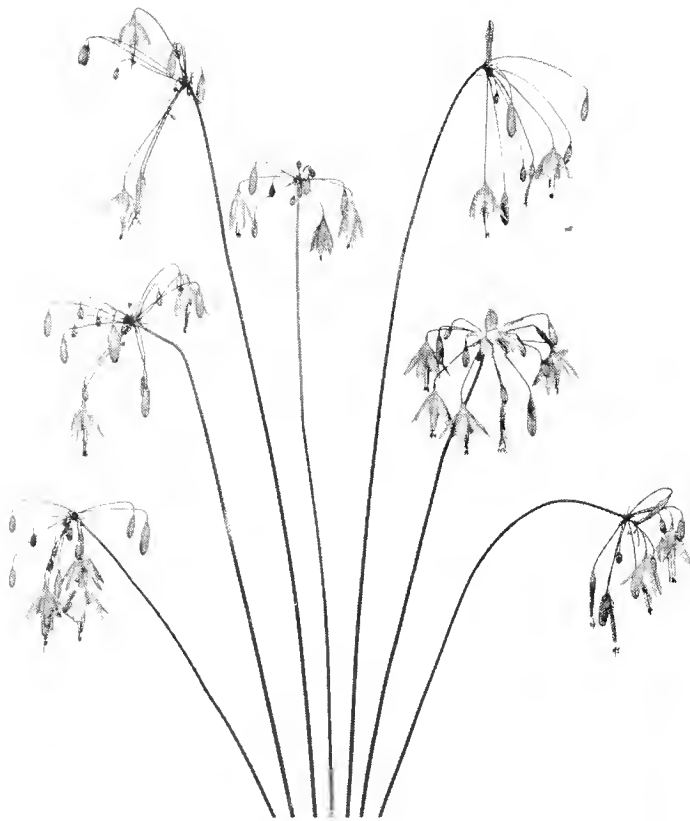

Bessera Elegans

**BESSERA ELEGANS (Mexican Coral Drops)**

Dainty bell-shaped flowers, orange-red outside, creamy white with orange stripe inside, stamens purple. Flowers hang in an interesting umbel from the tip of a graceful, wiry stem 18 to 24 inches tall. Blooms freely from July to last of September. Cuts well and is exceptionally interesting in floral arrangements. Should be dug up and stored during winter. Bulbs of Bessera Elegans have been quite scarce in recent years; fortunately we have been able to secure a fine lot of bulbs which we offer as follows: 3 for 60c; \$2.00 per doz.; \$15.00 per 100.

**BUDDLEIA HARTWEGI**

This new Buddleia is undoubtedly the finest of all the summer-flowering Butterfly Bushes. As a summer cut flower plant and as an ornamental shrub it is unsurpassed in beauty and usefulness. The large, bright lavender panicles have remarkable substance and do not "sunburn" as do some of the other varieties. The foliage is of a rich, dark green and is very heavy. This variety is exceptionally hardy.

Offered in plants from 2 1/4-inch pots, which will flower profusely the first year. 75c each; \$7.00 per 10.

**CHRYSANTHEMUM, NEW EARLY KOREAN HYBRIDS**

A selection of new varieties of these gorgeous autumn blooming plants will be found on page 75.

**GAILLARDIA GRANDIFLORA, RUBY**

Brilliant ruby-red without any yellow or brown markings. Very free flowering.

**GAILLARDIA GRANDIFLORA, MR. SHERBROOK**

Well formed flowers, golden yellow with pale yellow center. A continuous bloomer.

Above Gaillardias, 3-inch pot plants, ready April 1st. Grown from root cuttings. 3 for \$1.50; \$5.00 per doz.

**GYPSOPHILA REPENS BODGERI**

A dwarf Gypsophila growing two feet high and blooming at least two weeks earlier than any other double flowering form. White flowers, tinted pink. Very desirable for cutting.  
Strong plants, 3-inch pots, 3 for \$1.00; \$3.50 per doz.

**GYPSOPHILA REPENS, ROSY VEIL**

A novelty of European introduction similar in habit to Bodgeri, but with flowers of a somewhat more pronounced pink color.  
3-inch pots, 3 for \$1.00; \$3.50 per doz.

**SIX NEW GIANT HEMEROCALLIS**

Today the Hemerocallis (Day Lilies) are ranked among the most desirable herbaceous perennials and are unsurpassed for hardiness, ease of culture and freedom from disease. There are now many classes which surpass most of the older types.

	Each
Bay State. Good orange. August .....	\$0.75
Cinnabar. Bronzy orange. July-August .....	1.00
Dover. Large early gold .....	1.00
Gipsy. Very deep orange. Late July .....	2.00
Goldeni. Pure gold. Very free. July .....	.50
Mrs. W. H. Wyman. Late flowering gold .....	1.00
Set of six, one of each, for \$6.00.	

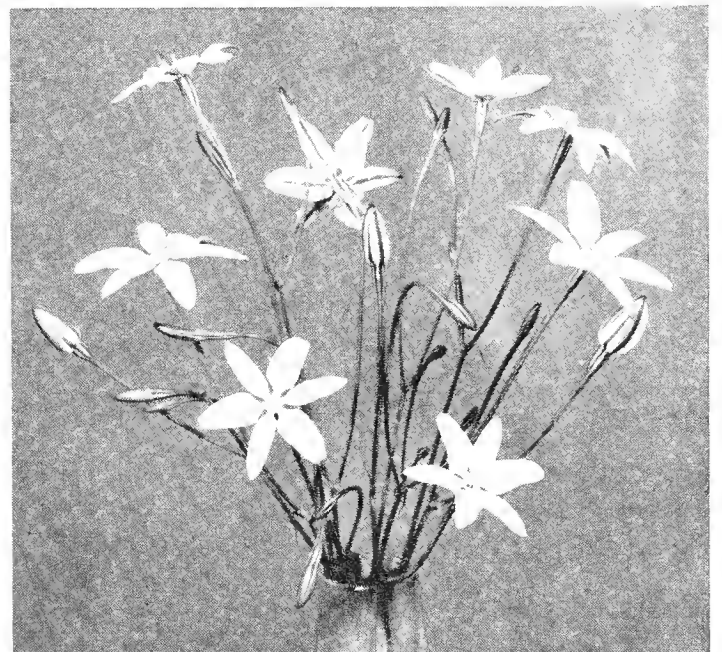

Milla Biflora

**MILLA BIFOLIA (Mexican Star of Bethlehem)**

This interesting bulb produces showy white flowers, waxy in texture, about two inches in diameter, opening up flat, with six petals. A faint stripe of soft apple-green runs from tip to base on the outside of each petal. The stems are wiry, 12 to 18 inches tall, bearing 2 to 7 flowers each, very free flowering. Flowers cut well and have a pleasant lily-like fragrance. Most attractive both in cut flower arrangements and in the garden. Should be taken up in the fall.  
3 for 60c; \$2.00 per doz.; \$15.00 per 100.

**PHLOX SUFFRUTICOSA, ROSALINDA**

This early flowering type of Phlox commences to bloom in May and continues in flower until freezing. Rosalinda has soft amaranth-pink blossoms borne in great profusion.  
3 for \$1.00; \$3.50 per doz.

**ROSE, TOM THUMB**

**The Smallest Red Rose in the World**  
Plant Patent No. 169. A tiny gem for rockery, border or pool's edge. Hardy and grows six inches high. Flowers rich crimson, white center, studded with gold stamens.  
Pot plants for April delivery, \$1.00 each; 6 for \$5.00.

# Flower Seeds for Different Purposes and Situations

For description and prices, see general list.

## CLIMBING VINES FROM SEEDS

Balloon Vine	Dolichos	Lathyrus	Maurandia	Thunbergia
Canary Bird Vine	Echinocystis	Kenilworth Ivy	Momordica	
Cobaea	Gourds	Kudzu Vine	Nasturtium	
Convolvulus	Humulus	Lophospermum	Passiflora	
Cypress Vine	Ipomoea	Mina lobata	Sweet Peas	

## FRAGRANT FLOWERS FROM SEEDS

Alyssum	Heliotrope	Nicotiana affinis	Sweet Rocket	Wallflower
Asperula	Lavender	Polyanthus	Sweet Sultan	
Carnations	Matthiola	Scabiosa	Sweet William	
Cleome	Mignonette	Stock	Verbena, Lemon	
Dianthus (Hardy)	Mimulus moschatus	Sweet Pea	Violet	

## PLANTS ADAPTED FOR EDGING BORDERS

Ageratum	Candytuft	Nasturtium	Phlox, Dwarf	Tagetes
Alyssum	Centaurea	Nemesia	Portulaca	Viola
Armeria	Lobelia	Nigella	Pyrethrum	Zinnia, Lilliput
Begonia	Marigold	Pennisetum	Sweet William	
Bellis	Myosotis	Petunia	Sweet Pea, Cupid	

## GREENHOUSE AND POT PLANTS FROM SEEDS

Abutilon	Celosia	Dracaena	Lantana	Sweet Peas
Acacia	Celsia	Ferns	Primula	Trachelium
Antirrhinum	Chrysanthemum	Francoa	Shamrock	Verbena
Angelonia	Cineraria	Freesia	Smilax	
Asparagus	Clerodendron	Gloxinia	Solanum	
Browallia	Clianthus	Grevillea	Stevia	
Begonias	Coleus	Heliotrope	Stocks	
Calceolaria	Cyclamen	Impatiens	Streptocarpus	

## EVERLASTING FLOWERS FOR WINTER DECORATIONS

Acroclinium	Globe Amaranth	Honesty (Lunaria)	Statice
Edelweiss	Helichrysum	Rhodanthe	Xeranthemum

## ORNAMENTAL FOLIAGE PLANTS FROM SEEDS

Amaranthus	Centaurea gymno-	Coleus	Kochia	Ricinus
Centaurea candi-	carpa	Corn, Rainbow	Perilla	
dissima	Cineraria maritima	Euphorbia	Pyrethrum aureum	

## PLANTS FROM SEEDS SUCCEEDING IN PARTIALLY SHADED PLACES

Anemone	Bellis	Digitalis	Mimulus	Poppies (Hardy)
Antirrhinum	Canterbury Bells	Ferns	Myosotis	Schizanthus
Aquilegia	Coreopsis (Hardy)	Hardy Primrose	Oenothera	Torenia
Auricula	Cowslip	Linum	Pansy	Violet
Begonia, Tuberous	Delphinium	Matricaria	Polyanthus	

## ANNUAL FLOWERS FROM SEED, SUITABLE FOR CUTTING

Agrostemma	Celosia plumosa	Dimorphotheca	Lupinus	Statice
Antirrhinum	Centaurea	Eschscholtzia	Marigolds	Stocks, Ten Week
Arctotis	Chrysanthemums	Gaillardia	Mignonette	Sunflower
Asters	Clarkia	Godetia	Nigella	Sweet Peas
Calendula	Cosmos	Gypsophila	Phlox	Sweet William
Calliopsis	Dahlia	Hunnemannia	Poppies	Verbena
Candytuft	Dianthus	Larkspur	Salpiglossis	Wallflower
Carnation	Didiscus	Lavatera	Scabiosa	Zinnias

## HARDY PERENNIALS WHICH CAN BE RAISED FROM SEEDS

Achillea	Callirhoe	Erinus	Lupinus	Romneya
Aconitum	Campanula	Eupatorium	Lychnis	Rudbeckia
Adonis	Candytuft	Gaillardia	Matricaria	Salvia
Agrostemma	Centaurea	Galega	Nierembergia	Scabiosa
Aistroemeria	Cerastium	Gaura	Pansies	Silene
Alyssum	Chelone	Geum	Pentstemon	Statice
Anchusa	Chrysanthemum	Grasses	Phlox	Stokesia
Anemone	Careopsis	Gypsophila	Physalis	Sweet William
Anthemis	Cowslip	Helenium	Physostegia	Trachelium
Aquilegia	Delphinium	Helianthus	Platycodon	Tritoma
Arabis	Dictamnus	Heuchera	Polemonium	Trollius
Asperula	Dianthus	Hibiscus	Polyanthus	Valeriana
Aster	Digitalis	Hollyhocks	Poppies	Verbena
Aubrietia	Echinops	Incarvillea	Potentilla	Verbascum
Auricula	Edelweiss	Lathyrus	Primula	Veronica
Bellis	Eremurus	Linaria	Pyrethrum	Viola
Bocconia	Frigeron	Linum	Rehmannia	Violet
Boltonia	Erysimum	Lobelia	Racket	Wallflower

Description and prices of any of the above seeds will be found on pages 10 to 34.

# Marshall's Matchless Flower Seeds

## ALL FLOWER SEEDS ARE MAILED FREE

The following list contains a most complete assortment of the choicest and most popular flowers for either conservatory, greenhouse or garden culture.

**Annuals** grow from seed, flower, mature their seed, and die in one year, or, in other words, the same season.

**Hardy Annuals** are those which can be sown in the open ground.

**Half-Hardy Annuals** are those which should be started early in the house, conservatory or hotbed, and transplanted to the garden in settled warm weather.

**Biennials** grow from seed, sown from June to August, ripen their seed and die the next year, though some varieties bloom the same season if sown early in gentle heat.

**Hardy Biennials** will winter in the open ground without protection.

**Half-Hardy Biennials** require the protection of a cold frame or cool house during Winter.

**Perennials** grow from seed, and continue flowering annually for many years after the first season. Some varieties flower the first season if planted early in gentle heat.

**Hardy Perennials** can remain in the open ground during Winter without protection.

**Half-Hardy Perennials** require the protection of a cold frame or cool house during the Winter.

**Tender or Greenhouse Perennials** require window or greenhouse culture, free from frost during Winter and thrive in the garden during the warm months.

## EXPLANATION OF FLOWER SEED ABBREVIATIONS

H.A.	designates	Hardy Annuals—Lasting but one year.
H.H.A.	"	Half-Hardy Annuals—Lasting but one year.
H.B.	"	Hardy Biennials—Lasting but two years.
H.H.B.	"	Half-Hardy Biennials—Require protection during Winter.
H.P.	"	Hardy Perennials—Lasting three or more years.
H.H.P.	designates	Half-Hardy Perennials—Require protection during Winter.
H.C.	"	Hardy Climber—Lasting three or more years.
H.A.C.	"	Hardy Annual Climber.
G.P.	"	Greenhouse Plant.



Adonis Vernalis



Ageratum

		Pkt.
<b>ABRONIA umbellata.</b>	H.A. Trailing annual pink flower trusses, 9 in. ....	1/4 oz. 35c. \$0.10
<b>ABUTILON, New Hybrids.</b>	G.P. Large bell-shaped flowers. Mixed colors .....	.25
<b>ACACIA.</b>	G.P. Finest mixed, elegant Winter and Spring flowering plants .....	1/4 oz. 50c. .15
<b>ACHILLEA ptarmica, "The Pearl."</b>	H.P. Double white flowers .....	1/8 oz. \$1.00. .25
<b>ACONITUM napellus.</b>	H.P. Dark blue flowers in August. ....	1/4 oz. \$1.00. .15
<b>Wilsoni.</b>	Light blue flowers in large trusses. ....	1/16 oz. \$1.00. .25
<b>ACROCLINIUM.</b>	H.A. Pretty everlasting flowers; fine for Winter bouquets. 1 ft. ....	
<b>album.</b>	Pure white; double flowers. ....	1/4 oz. 25c. .10
<b>roseum.</b>	Bright rose; double flowers. ....	1/4 oz. 30c. .10
<b>Finest Mixed Colors</b>	.....	1/4 oz. 20c. .10
<b>ADONIS autumnalis.</b>	H.A. Crimson flowers with dark centers. 1 ft. ....	1/4 oz. 35c. .15
<b>vernalis.</b>	H.P. Large, yellow; flowers in early Spring. 9 in. ....	1/4 oz. 75c. .15
<b>AGATHAEA caelestis (Blue Marguerite).</b>	H.H.P. Pretty blue Daisy-like flowers. An excellent pot plant. 1 1/2 ft. ....	1/4 oz. 75c. .15
<b>AGERATUM.</b>	H.A. Blooms throughout the Summer; feathery flowers in clusters. ....	
<b>Blue Cap.</b>	A very dwarf variety .....	1/8 oz. \$1.00 .15
<b>mexicanum.</b>	Fine for bedding or pot culture. Blue. 1 1/2 ft. ....	1/4 oz. 30c. .10
<b>mexicanum album.</b>	A beautiful white variety. 1 1/2 ft. ....	1/4 oz. 30c. .10
<b>Imperial Dwarf Blue.</b>	Extra neat; fine for edging. 9 in. ....	1/4 oz. 50c. .15
<b>Imperial Dwarf White.</b>	Pretty for contrast; fine for edgings. 9 in. ....	1/4 oz. 50c. .15
<b>Blue Perfection.</b>	Very fine dwarf. 9 in. ....	1/4 oz. 50c. .15
<b>Little Blue Star.</b>	Light blue; fine for carpet bedding. 6 in. ....	1/4 oz. \$1.00. .25
<b>Princess Victoria Louise.</b>	Dwarf, light blue, white center. 9 in. ....	1/4 oz. 50c. .15
<b>Swanley Blue.</b>	A fine, large-flowered sort. 1 ft. ....	1/4 oz. 50c. .15



Anemone Coronario

- Pkt.
- AGROSTEMMA coeli-rosa** (Rose of Heaven). H.A. Bright rose, excellent for cutting. 18 in. . . . . ¼ oz. 35c. \$0.10
- coeli-alba**. White . . . . . ¼ oz. 25c. .10
- coronario** (Rose Campion). H.P. Crimson flowers, silver foliage. 2 ft. . . . . ¼ oz. 35c. .10
- ALONSOA Worscewiczii compacta**. H.A. For pots or outside planting. Foliage dark green with racemes of bright scarlet flowers. 15 in. . . . . .25
- ALSTROEMERIA HYBRIDS.**  
Mixed. Lily-like perennials with clusters of flowers on long stems in yellow and orange-red shades. 3 ft. . . . . .25
- ALYSSUM**. H.A. Pretty little plants for beds, vases or along edgings or rockwork; blooming profusely all summer.
- maritimum** (Sweet Alyssum) Fragrant white; flowers all Summer. 6 in. . . . . oz 50c. .10
- maritimum compactum, Little Gem**. Grows erect; fine for edging . . . . . oz. 75c. .10
- Benthami compactum, Lilac Queen**. Pure lilac flowers, dwarf and compact growth. 6 in. . . . . ¼ oz. 35c. .10
- Benthami compactum lutescens**. Yellowish flowers on strictly upright flower spikes 6 in. . . . . ¼ oz. 35c. .10
- procumbens (Carpet of Snow)**. Dwarf; pure white. 4 in. . . . . ¼ oz. 50c. .10
- saxatile compactum**. H.P. Spring-blooming Alyssum with yellow flowers. 12 in. . . . . ¼ oz. 75c. .15
- saxatile, Silver Queen**. H.P. An early Spring-blooming perennial with masses of pale lemon flowers. 1 ft. ¼ oz. 75c. .15

- Pkt.
- AMARANTHUS**. H.A. Ornamental foliage plants, producing a striking effect either in the conservatory or flower garden.
- bicolor ruber**. Dark red leaves, carmine tips . . . . . \$0.25
- caudatus** (Love-lies-bleeding). Long drooping crimson spikes. 3 ft. . . . . ¼ oz. 35c. .10
- salicifolius** (Fountain Plant). Distinct, graceful drooping leaves. 2 ft. . . . . ¼ oz. 35c. .10
- tricolor** (Joseph's-coat). Leaves red, yellow and green. 2 ft. . . . . ¼ oz. 50c. .10
- AMPELOPSIS Veitchii** (Japanese Woodbine, or Boston Ivy). H.C. . . . . ¼ oz. 40c. .10
- ANAGALLIS grandiflora**. H.H.A. Mixed colors. Showy garden plant. 6 in. . . . . ¼ oz. 35c. .10
- ANCHUSA copensis**. H.A. Flowers resembling large Forget-me-nots. 18 in. . . . . ¼ oz. 75c. .10
- grandiflora** (Dropmore Variety). H.P. Large flowered, dark blue. 5 ft . . . . . ¼ oz. 50c. .15
- ANEMONE**. H.P. A very pleasing perennial, producing large flowers. 12 in.
- coronario, St. Brigid** . . . . . ⅛ oz. 75c. .15
- coronario. Double Chrysanthemum Mixed**. Great variety of colors, good double flowers . . . . . ⅛ oz. 50c. .15
- japonica**. Pink. 2 to 3 ft. . . . . .25
- japonica alba**. White . . . . . .25
- ANGELONIA grandiflora**. G.P. A sweet-scented greenhouse plant with dainty mauve sprays of flowers. 2 ft. . . . . .25
- ANTHEMIS Kelwayi**. H.P. Yellow flowers, 3 ft. . . . . ¼ oz. 75c. .15



Alstroemeria Hybrids

**ANTIRRHINUM.** H.H.B. The Snopdragon is one of the finest biennols, flowering the first year as annuals. Their rich colors and keeping qualities os cut flowers moke them most desirable.

Greenhouse Forcing Varieties:	Pkt.
<b>Afterglow.</b> A splendid glowing bronze .....	\$1.00
<b>Ceylon Court.</b> A soft Mondorin yellow .....	1.00
<b>Cheviot Maid Supreme.</b> Deep pink .....	1.00
<b>Geneva Pink.</b> Exquisite deep pink .....	1.00
<b>Jennie Schneider.</b> Soft brilliant pink .....	1.00
<b>Matchless White.</b> A selected strain .....	.50
<b>Matchless Yellow.</b> A fine stroin .....	.50
<b>Philadelphia Pink.</b> A beautiful pink .....	.50
<b>Rase Queen.</b> A rich dork rose .....	1.00
<b>Sun Tan.</b> Rosy shade of tan and yellow .....	1.00
<b>Terry's Surprise Improved.</b> Pink and bronze shodes .....	1.00
<b>White Rock.</b> White .....	1.00
<b>Winter Helen.</b> Salmon-pink .....	1.00

**Large-Flowering Half-Dwarf Varieties.** The best for bedding purposes, growing about 18 inches high.

<b>Black Prince.</b> Dork leaved, blockish crimson purple. ....	1/8 oz. 50c. .15
<b>Defiance.</b> Fiery scarlet .....	1/8 oz. 50c. .15
<b>Golden Queen grandiflora.</b> Pure yellow .....	1/8 oz. 50c. .15
<b>Queen of the North.</b> White .....	1/8 oz. 50c. .15
<b>Roseum superbum.</b> Rosy pink .....	1/8 oz. 75c. .15
<b>Silver Queen.</b> A distinct color of pure silvery liloc. A beautiful color under artificial light .....	.15
<b>The Bride.</b> White, chonging to delicate rose ...	1/8 oz. 50c. .15
<b>Fine Mixed.</b> All colors .....	1/4 oz. 60c. .15
<b>Collection of six above varieties</b> .....	.75

**Marshall's Giant-Flowering Varieties.** These grow about 3 feet high and are all of the large-flowering types.

<b>Bonfire.</b> Bright cinnabar-red, yellow blotch ....	1/4 oz. 75c. .15
<b>Caral Red.</b> Rich, with red throat .....	1/4 oz. 75c. .15
<b>Defiance.</b> Fiery scarlet .....	1/4 oz. 75c. .15
<b>Firefly.</b> Scorlet and yellow .....	1/4 oz. 50c. .15
<b>Indian Summer.</b> A rich velvety and glossy copper color. ....	1/4 oz. \$1.00. .15
<b>Queen Victoria.</b> Large white .....	1/4 oz. 50c. .15
<b>Roseum.</b> Rose .....	1/4 oz. 50c. .15
<b>Ruby.</b> Pure ruby-red .....	1/4 oz. 50c. .15
<b>Salmon Pink.</b> Very large flowering .....	1/4 oz. 50c. .15
<b>Striped.</b> Odd ond pretty .....	1/4 oz. 50c. .15
<b>Venus.</b> Delicote rose on white ground .....	1/4 oz. 50c. .15
<b>Giant Yellow</b> .....	1/4 oz. 60c. .15
<b>Giant Large-Flowered Mixed.</b> Fine variety of colors. ....	1/4 oz. 50c. .10
<b>Collection of six distinct varieties</b> .....	.75
<b>Collection of twelve distinct varieties</b> .....	1.50

**AQUILEGIA (Columbine).** H.P. Fine, free flowering hardy border plant—one of our most desiroble perennials. Seed may be planted in the open ground early in spring and will in some varieties bloom in the some season. Best results, however, are obtained by planting in August for next season's blooming.

<b>Marshall's Matchless Long-Spurred Hybrids.</b> A grond variety of colors of the long-spurred and large-flowered forms. 3 ft. ....	1/16 oz. \$1.00. \$0.25	Pkt.
--	-------------------------	------

	Pkt.
<b>caerulea.</b> Pale blue and white flowers with long spurs. Height 2 feet .....	1/8 oz. 75c. \$0.15
<b>chrysantha.</b> Long-spurred, golden yellow. 2 ft. ..	1/8 oz. 75c. .15
<b>chrysantha grandiflora alba.</b> Large pure white. 2 feet. ....	1/8 oz. \$1.00. .25
<b>Copper Queen.</b> A rich glowing coppery red with long spurs of deeper hue .....	.25
<b>glandulosa vera.</b> (True). Dark blue ond white. 12 in. ....	.50
<b>Marshall's Rose Queen.</b> A beautiful selection of long-spurred rose shodes .....	.25
<b>Skinneri.</b> A beautiful scarlet, tipped green. 2 ft. 1/8 oz. \$1.00. ....	.15
<b>Single.</b> Mixed colors .....	1/4 oz. 75c. .15
<b>Dauble-Flowering.</b> Mixed colors .....	1/4 oz. 75c. .15

**ARABIS alpina.** H.P. Excellent for borders or rockwork. Pure white. 6 in. ....

	Pkt.
<b>ARCTOTIS grandis.</b> H.A. Doisy-like flowers; white shaded blue. 2 ft. ....	1/4 oz. 75c. \$0.15
<b>Hybrids.</b> A variety of colors .....	.35
<b>ARMERIA formosa, Giant Thrift.</b> H.P. A pretty edging plant with deep pink flowers. 12 in. ....	1/4 oz. 75c. .15
<b>ASPARAGUS plumosus nanus.</b> G.P. Graceful and feothy bright green foliage. 8 ft. ....	100 seeds, \$1.00. .25
<b>Sprengeri.</b> A handsome variety of rapid growth for honging baskets. 3 ft. ....	100 seeds, 50c. .15
<b>ASPERULA odorata</b> (Woodruff). H.P. The white flowers ond foliage are perfumed. 12 in. ....	1/4 oz. 50c. .15
<b>ASTER.</b> (Perennial). ....	.
<b>Farreri.</b> H.P. The flowers ore single with violet-mauve petals and a large golden orange disc, often 2 1/2 inches in diometer produced on long, stiff, noked stems. Commencing to bloom in May .....	.50
<b>Michaelmas Daisy.</b> H.P. Large flowering, hardy mixed, full-flowering varieties; rich shades of purple, lavenders, etc. 2 1/2 ft. ....	1/8 oz. \$1.00. .25

## ASTERS

Your success with Asters depends primarily upon the kind of seed you sow. Marshall's Wilt Resistant Asters ore from the most carefully selected strains of these beautiful annual flowers.

Asters prefer a good heavy loam enriched with bone meal. The majority of the following varieties ore

### WILT RESISTANT STRAINS

	1/4 oz.	Pkt.
<b>EARLY BEAUTY.</b> Large well-formed flowers on stout stems, branching habit. 2 to 3 ft. ....		
<b>Azure Fairy.</b> Wilt Resistant .....	\$1.25	\$0.15
<b>Deep Rose.</b> Wilt Resistant .....	1.25	.15
<b>Flesh Pink.</b> Wilt Resistant .....	1.25	.15
<b>Purple.</b> Wilt Resistant .....	1.25	.15
<b>White.</b> Wilt Resistant .....	1.25	.15
<b>Finest Mixed.</b> Wilt Resistant .....	1.25	.15

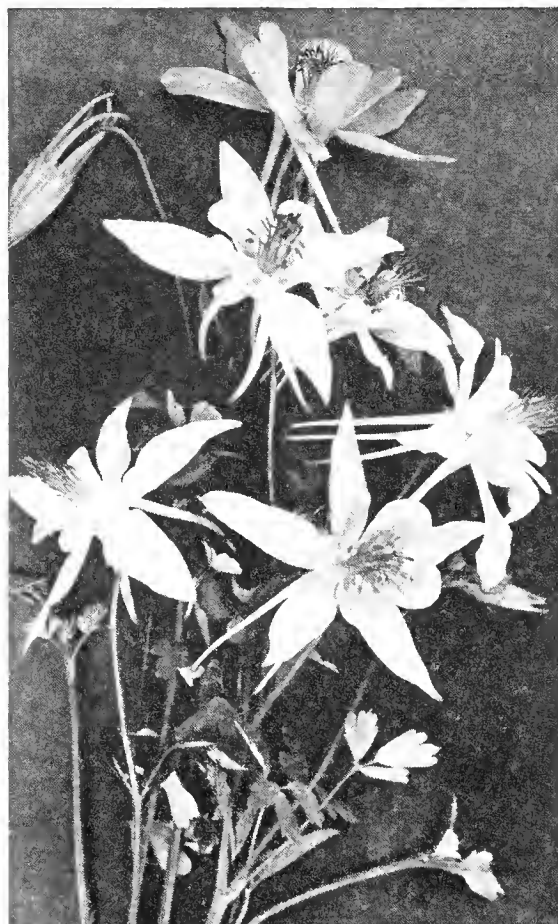

Aquilegia, Matchless Long-spurred





Branching Comet Aster

ASTERS—Continued.

	¼ oz.	Pkt.
<b>GIANT BRANCHING COMET.</b> A Giant Comet type of Branching Aster. 2 to 3 ft.		
Crimson. Wilt Resistant .....	\$1.15	\$0.15
Deep Rose. Wilt Resistant .....	1.15	.15
Light Blue. Wilt Resistant .....	1.15	.15
Royal Purple. Wilt Resistant .....	1.15	.15
Shell Pink. Wilt Resistant .....	1.15	.15
White. Wilt Resistant .....	1.15	.15
Mixed. Wilt Resistant .....	1.00	.10
Collection of Six Colors .....		.75
<b>GIANT CALIFORNIA SUNSHINE.</b> Large flowers 4-5 inches across, with single row of petals contrasting with yellow or blue centers. 2½ to 3 ft.		
Deep Rose .....	2.00	.25
Enchantress Pink .....	2.00	.25
Light Blue .....	2.00	.25
Purple .....	2.00	.25
White .....	2.00	.25
Finest Mixed .....	2.00	.25
<b>GIANTS OF CALIFORNIA.</b> An improved form of Crego with flowers 6 inches across, packed with broad petals. 3 ft.		
Dark Purple. Wilt Resistant .....	1.50	.20
Deep Rose .....	1.00	.15
Light Blue .....	1.00	.15
Peach Blossom .....	1.00	.15
White .....	1.00	.15
Finest Mixed .....	1.00	.15
<b>IMPROVED GIANT BRANCHING.</b> The flowers are large, fine for cutting. 2½ to 3 ft.		
Azure Blue. Wilt Resistant .....	1.25	.15
Crimson. Wilt Resistant .....	1.25	.15
Light Rose. Wilt Resistant .....	1.25	.15
Purple. Wilt Resistant .....	1.25	.15
Shell Pink. Wilt Resistant .....	1.25	.15
White. Wilt Resistant .....	1.25	.15
Finest Mixed. Wilt Resistant .....	1.25	.15
Collection Six Colors .....		.75

	¼ oz.	Pkt.
<b>MARSHALL'S KING.</b> Upright growth; large flowers, long petals. 2 ft.		
Crimson. Wilt Resistant .....	\$1.25	\$0.15
Lavender. Wilt Resistant .....	1.25	.15
Rose. Wilt resistant .....	1.25	.15
Violet .....	1.00	.15
White. Wilt Resistant .....	1.25	.15
Finest Mixed. Wilt Resistant .....	1.25	.15

	¼ oz.	Pkt.
<b>OSTRICH PLUME.</b> Splendid class, fine for cutting. 18 in.		
Crimson. Wilt Resistant .....	1.25	.15
Light Blue. Wilt Resistant .....	1.25	.15
Deep Rose. Wilt Resistant .....	1.25	.15
White. Wilt Resistant .....	1.25	.15
Finest Mixed. Wilt Resistant .....	1.25	.15

	¼ oz.	Pkt.
<b>QUEEN OF THE MARKET.</b> An early flowering Aster, having long stems for cut flowers. 20 in.		
Crimson. Wilt Resistant .....	1.00	.15
Dark Blue. Wilt Resistant .....	1.00	.15
Light Blue. Wilt resistant .....	1.00	.15
Flesh Pink. Wilt Resistant .....	1.00	.15
Deep Rose .....	.75	.10
White. Wilt Resistant .....	1.00	.15
Finest Mixed. Wilt Resistant .....	1.00	.15

	¼ oz.	Pkt.
<b>SINENSIS SINGLE.</b> Daisylike flowers; wide petals closely placed. 2 ft.		
Light Blue. Wilt Resistant .....	1.00	.15
Flesh Pink. Wilt resistant .....	1.00	.15
Scarlet. Wilt Resistant .....	1.00	.15
Dark Blue. Wilt Resistant .....	1.00	.15
White. Wilt Resistant .....	1.00	.15
Finest Mixed. Wilt Resistant .....	.75	.10

VARIOUS ASTERS

<b>CHRYSANTHEMUM - FLOWERED.</b> Dwarf. A splendid variety of compact habit. 12 in.		
Finest Mixed Colors .....	1.00	.15
<b>EVERLASTING FLESH.</b> Resembles a large Helichrysum. Wilt Resistant .....		.25
<b>HEART OF FRANCE.</b> Rich dark red, nicely branched. 24 in. Wilt Resistant .....	1.75	.25
<b>PEERLESS YELLOW.</b> Canary-yellow. 2 ft. ....	1.25	.15

**SUPER GIANT LOS ANGELES.** Immense shell-pink flowers, ostrich feather type. 3 ft. .... 2.00 .25

**ASTERS—**Perennial varieties—See page 67.

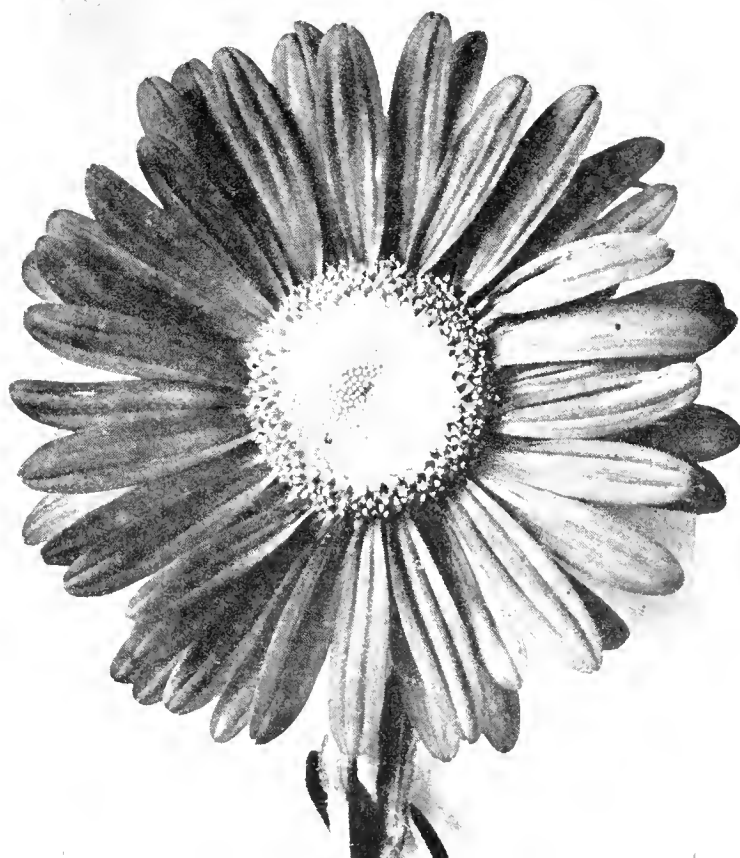

Aster, Sinensis Single

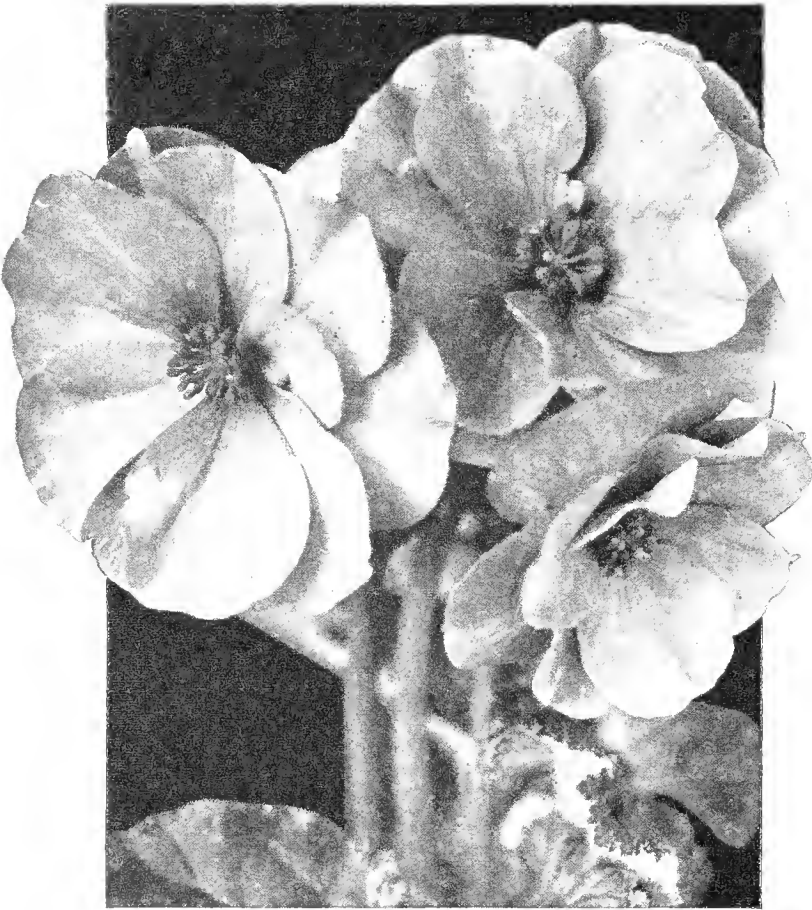

Tuberous-Rooted Begonia, Single

		Pkt.
<b>BEGONIA, Tuberous-rooted.</b> G.P. Produce magnificent flowers; grown either in pots or for bedding.		
<b>Marshall's Giant Single, Mixed.</b> 12 in. ....		\$1.00
<b>Marshall's Giant Double, Mixed.</b> 12 in. ....		1.00
<b>Rex Varieties.</b> Ornamental leaves. 12 in. ....		1.00
<b>BELLIS perennis fl. pl.</b> (Double English Daisy). H.P. Spring-flowering perennial. 6 in.		
<b>Longfellow.</b> Dark rose .....	1/8 oz.	\$1.00 .25
<b>Snowball.</b> Pure white.....	1/8 oz.	\$1.00 .25
<b>Giant Red.</b> Dark red.....	1/8 oz.	\$1.00 .25
<b>Giant Mixed</b> .....	1/8 oz.	\$1.00 .25
<b>BLUE LACE FLOWERS</b> (See <i>Didiscus caeruleus</i> ).		
<b>BOCCONIA japonica.</b> (Cordata). H.P. Very ornamental; flowers white. 6 ft. ....	1/4 oz.	50c. .15
<b>BOLTONIA asteroides.</b> H.P. Pure white Aster-like flowers. 6 ft. ....		.15
<b>latisquama.</b> Pink flowers, tinged with lavender. 5 ft. ....		.15
<b>BRACHYCOME iberidifolia.</b> H.H.A. The well-known "Swan-River Daisy" is a beautiful little, half-hardy annual; pretty blue flowers. 18 in. ....	1/4 oz.	50c. .15
<b>iberidifolia, Mixed.</b> (Swan-River Daisy). For edging. 12 in. ....	1/4 oz.	50c. .15
<b>BROWALLIA.</b> H.A. Profuse-blooming annual, highly prized for cutting. 2 ft.		
<b>elata caerulea.</b> Bright blue .....	1/8 oz.	\$1.00 .25
<b>speciosa major.</b> Flowers 1 1/2 to 2 in. across; blue, white throat .....	1/16 oz.	\$2.00 .25
<b>viscosa compacta, Sapphire.</b> Compact habit, dark blue flowers. 9 in. ....		.35
<b>CACALIA coccinea</b> (Tasselflower). H.A. Scarlet flowers. 2 ft. ....	1/4 oz.	50c. .10
<b>CALCEOLARIA hybrida grandiflora.</b> G.P. Highly prized plants for conservatory and house decoration.		
<b>Marshall's Matchless Strain.</b> Finest spotted, in the most marvelous variety of shades and marking .....		.75
<b>Large Flowering "Dalkeith Park Strain."</b> Finest varieties ...		.50
<b>rugosa Mixed.</b> Bedding varieties. 12 in. ....		.50
<b>CALENDULA</b> (Cape Marigold). H.A. Free flowering garden plants. 12 in.		
<b>Ball's Lemon.</b> Large lemon calar .....	1/4 oz.	75c. .15
<b>Ball's Orange.</b> Large orange .....	1/4 oz.	75c. .15
<b>Campfire.</b> The best orange .....	1/4 oz.	\$1.00 .25
<b>Chrysantha.</b> Deep buttercup yellow .....	1/4 oz.	75c. .25
<b>Meteor.</b> Double yellow, striped orange .....	Oz.	75c. .10
<b>Orange King.</b> Double rich orange, red flowers .....	Oz.	75c. .10
<b>Orange Shaggy.</b> Deeply lacinated petals .....	1/4 oz.	75c. .10
<b>Sulphur Crown.</b> Double, yellow .....	Oz.	75c. .10
<b>Finest Mixed.</b> All varieties .....	Oz.	50c. .10
<b>CALLIOPSIS.</b> H.A. Nothing is more effective than a large bed of these golden flowers.		
<b>atrosanguinea.</b> Rich dark red. 18 in. ....	1/4 oz.	50c. .10
<b>compacta, Crimson King.</b> Deep bright scarlet. 18 in. ....	1/4 oz.	50c. .10
<b>Golden Wave</b> (Drummond). Pure yellow flowers, very large and showy .....	1/4 oz.	50c. .10
<b>marmorata.</b> Maroon and gold. 18 in. ....	1/4 oz.	50c. .10
<b>tinctoria.</b> Large bright yellow and maroon flowers. 2 ft. ....	1/4 oz.	50c. .10
<b>Dwarf, Finest Mixed.</b> All shades of yellow, red and brown. 12 in. ....	1/4 oz.	50c. .10
<b>Tall Mixed.</b> A grand variety for cutting. 2 ft. ....	1/4 oz.	50c. .10
<b>CALLIRHOE involucreta</b> (Poppy Mallow). H.P. Beautiful trailing plant; flowers large, crimson, with white center. 12 in. ....	1/8 oz.	75c. .15
<b>CAMPANULAS.</b> H.P. All the Campanulas can be grown in ordinary gardens and will flower from seeds the following year.		
<b>carpatica.</b> Deep blue; for rockeries, beds and edgings. 6 in. ....	1/4 oz.	75c. .15
<b>carpatica alba.</b> Flowers white. 6 in. ....	1/4 oz.	75c. .15
<b>pyramidalis</b> (Chimney Bell). Very conspicuous towering spikes, with clear blue flowers. 4 ft. ....	1/4 oz.	\$1.00 .15
<b>pyramidalis alba.</b> Pure white. 4 ft. ....	1/4 oz.	\$1.00 .15

**CAMPANULA—Continued.**

<i>persicifolia grandiflora</i> , Blue. Superb large flowers. 2 ft. . . . .	Pkt.	
..... 1/8 oz. \$1.25.	\$0.25	
<i>persicifolia grandiflora alba</i> . A white-flowered variety. . . . .		
..... 1/8 oz. \$1.25	.25	
<i>persicifolia</i> , <i>Telham Beauty</i> . China blue, very large flowers. 2 ft. . . . .		.35
<i>persicifolia grandiflora</i> , Fine Mixed. 2 ft. . . . .	1/8 oz. \$1.25	.25
<i>rotundifolia</i> (Harebell). Pale blue, slender. 1 ft. . . . .		.25
<b>medium</b> . (Canterbury Bells.) H.B. Old-fashioned, hardy biennials; splendid for borders or for naturalizing in the wild garden. 3 ft.		
<b>Single. Blue, Lavender, Rose, White or All Colors mixed.</b> . . . . .	each 1/4 oz. 50c	.10
<b>Double.</b>		
<b>Blue, White or Rose</b> . . . . .	each 1/4 oz. \$1.00	.15
<b>Mixed</b> . . . . .	1/4 oz. 75c.	.15
<i>calycanthema</i> (Cup and Saucer). A splendid variety with large, semi-double flowers resembling a cup and saucer. Fine for cut flowers or border use. 3 ft.		
<b>Blue, Lavender, Rose or White</b> . . . . .	1/4 oz. \$1.00	.15
<b>Mixed</b> . . . . .	1/4 oz. 75c.	.15
<b>New Annual Canterbury Bells.</b> These bloom from seed in six months. Mixed colors . . . . .		.35



Campanula, medium

<b>CANARY BIRD VINE.</b> H.A.C. Pretty climber, with yellow, butterfly-like flowers. 10 ft. . . . .	Pkt.	oz. 75c. \$0.10
<b>CANDYTUFT.</b> H.A. Showy plants, much grown in mosses in beds or for edging. 12 in.		
<b>coronaria, Empress.</b> A large-flowered variety of purest white, grown extensively for cut flowers. 12 in. . . . .	1/4 oz. 50c.	.10
<b>coronaria, Little Prince.</b> Very large heads of pure white flowers. 6 in. . . . .	1/4 oz. 50c.	.10
<b>coronaria, Giant Hyacinth-flowered.</b> White . . . . .	1/4 oz. 50c.	.10
<b>Marshall's White Perfection.</b> A grand white variety. . . . .	1/4 oz. 50c.	.10
<b>Rose Cardinal.</b> Bright rosy cardinal, a rich and striking color. Improved stock . . . . .	1/4 oz. 75c.	.15
<b>umbellata dunnetti.</b> Crimson . . . . .	1/4 oz. 50c.	.10
<b>umbellata lilacina.</b> Lilac-purple . . . . .	1/4 oz. 50c.	.10
<b>Queen of Italy.</b> Rosy lilac. 6 in. . . . .	1/4 oz. 50c.	.10
<b>umbellata Dwarf Hybrids.</b> Mixed colors; neat and pretty. 6 in. . . . .	1/4 oz. 50c.	.10
<b>Mixed Annual Sorts</b> . . . . .	Oz. 75c.	.10

**Perennial Varieties**

<b>gibraltarica.</b> H.P. Beautiful bluish-white. 12 in. . . . .	1/4 oz. \$1.00	.15
<b>sempervirens.</b> H.P. White flowers. 12 in. . . . .	1/8 oz. \$1.00	.25

**CANNAS.** G.P. Handsome foliage and flowering plants, producing striking effects in beds or borders. Soak the seed in hot water 24 hours before sowing. 3 to 4 ft. (For Canna roots, see Page 52).

**Crozy's Large Flowering.** Dwarf, mixed varieties. . . . . oz. 60c .10

**CANTERBURY BELLS.** H.B. (See *Campanula medium*).

**CARDINAL CLIMBER.** H.A.C. (See *Ipomoea cardinalis*).

**CARNATION. Marguerite.** H.H.P. The perpetual flowering Carnations produce a large proportion of double flowers in six months from sowing. 18 in.

<b>Marshall's Giant, Double Pink</b> . . . . .	1/8 oz. \$1.00	.15
<b>Marshall's Giant, Double Scarlet</b> . . . . .	1/8 oz. \$1.00	.15
<b>Marshall's Giant, Double White.</b> Large, perfect flowers. . . . .	1/8 oz. \$1.00	.15
<b>Marshall's Giant, Double Yellow.</b> A clear soft shade. . . . .	1/8 oz. \$1.00	.15
<b>Marshall's Giant Double Mixed.</b> Extra large and perfect flowering, in a rich variety of colors . . . . .	1/8 oz. \$1.00	.15
<b>Chabaud's Everblooming Mixed.</b> Blooms in five months after being sown, and continues to flower in the greatest profusion indefinitely. 18 in. . . . .	1/4 oz. \$1.50	.25
<b>Early Dwarf Vienna.</b> Double mixed. 12 in. . . . .	1/4 oz. 75c.	.15
<b>Grenadin Double Scarlet.</b> Very early flowering. 18 in. . . . .	1/4 oz. \$1.00	.15
<b>Finest Double Mixed. Border.</b> Saved from extra fine flowers. 18 in. . . . .	1/4 oz. \$1.00	.15

**CASTOR BEANS.** (See *Ricinus*.)

**CELOSIA Childsi** (Chinese Woolflower). A variety of feathered Celosia with large globular flower-heads like balls of wool. 2 ft.

<b>Childsi Crimson</b> . . . . .	1/8 oz. 75c.	.15
<b>Pink</b> . . . . .	1/8 oz. 75c.	.15
<b>Yellow</b> . . . . .	1/8 oz. 75c.	.15
<b>Mixed</b> . . . . .	1/8 oz. 50c.	.15
<b>cristata, or Cockscomb.</b> H.H.A. Popular annual of easy culture, producing Cockscomb-like heads.		
<b>Empress.</b> Crimson combs; dark foliage. 9 in. . . . .	1/4 oz. \$1.25	.15
<b>Glasgow Prize.</b> Large, deep crimson. 12 in. . . . .	1/4 oz. \$1.25	.15
<b>Queen of the Dwarfs.</b> Very dwarf form, deep crimson. 6 in. . . . .	1/8 oz. \$1.25	.25
<b>Dwarf.</b> Mixed colors. Extra fine strain. 9 in. . . . .	1/4 oz. 75c.	.10

**CELOSIA plumosa, or Ostrich Plume.** H.H.A. Producing large, graceful plumes. Makes fine plants for large beds or groups, and the plumes or flowers can be cut and dried for Winter bouquets. 3 ft.

**CELOSIA HEATHERDELL, Ostrich Plume** (Greenhouse Strain). Beautiful range of colors, including yellow, pink and red shades. Suitable for pots or outside . . . . . 75

<b>pyramidalis magnifica aurea.</b> Golden-yellow plumes. . . . .	1/4 oz. 50c.	.15
<b>Kermesina.</b> Crimson plumes . . . . .	1/4 oz. 50c.	.15
<b>coccinea.</b> Scarlet plumes . . . . .	1/4 oz. 50c.	.15

	Pkt.
<b>CELOSIA—Continued.</b>	
Thompson's Superb. Feathery plumes; dwarf habit, dark crimson	1/4 oz. 75c. \$0.15
plumosa, Mixed. Feathered varieties	1/4 oz. 50c. .15
Pride of Castle Gould. All shades in choicest mixture; branching habit	1/8 oz. \$1.00 .25
spicata. Rose changing to silver. 3 ft.	.15
<b>CELSIA arcturus.</b> G.P. Long spikes of bright yellow flowers. Fine for pot culture in cool greenhouse	.50
<b>CENTAUREA.</b> H.A. Beautiful silvery foliaged bedding plants; used for bordering and edging.	
canadissima. Round, compact plants, white leaves, broadly cut. 12 in.	1/8 oz. 75c. .15
gymnocarpa. Fine cut silvery foliage. 18 in.	1/4 oz. 50c. .15
<b>CENTAUREA.</b> H.A. They flower finest in full sun and poor soil. Sow in the open ground in Spring.	
americana. Bushy garden plants; lavender-blue, fragrant. 3 ft.	1/4 oz. 60c. .15
americana alba	1/4 oz. 60c. .15
Chameleon. Large; yellow and rose. 18 in.	1/4 oz. 75c. .15
Margaritae. Pure white, 2 1/2 inches across, exquisitely lacinated and delightfully scented. 18 in.	1/4 oz. 50c. .15
montana. (Perennial Cornflower). Large flowers of deep purple, very showy. 2 ft.	1/4 oz. 50c. .15
suaveolens (Yellow Sweet Sultan). 18 in. An outstanding variety with fine, soft yellow flowers on long stems. For outdoor or conservatory use it is unsurpassed.	1/4 oz. 50c. .15
<b>CENTAUREA cyanus</b> (Bachelor Button, Cornflower, Blue Bottle, or Ragged Sailor). H.A. This is one of the most popular annuals; will grow in the poorest soil, either on seashore or mountain. 3 ft.	
Marshall's Double Blue. Fine for cutting	1/4 oz. 40c. .10
Liberty Blue. The true Emperor deep blue	1/4 oz. 50c. .10
Jubilee Gem. A dwarf Cornflower. 12 inches high with double blue flowers	1/4 oz. 75c. .15
rosea, Double. Rose-pink	1/4 oz. 40c. .10
White, Double. Very pretty	1/4 oz. 40c. .10
Finest Mixed, Double	1/4 oz. 25c. .10
<b>CENTAUREA imperialis, Giant Imperial Sweet Sultan.</b> H.H.A. 3 ft. Fine for massing in borders and are unsurpassed for cut flower purposes. They also respond to indoor culture and provide a long succession of bloom for winter decoration.	
Amaranth Red	1/4 oz. 50c. .15
Lilac	1/4 oz. 50c. .15
Purple	1/4 oz. 50c. .15
Rose	1/4 oz. 50c. .15
White	1/4 oz. 50c. .15
Finest Mixed. All colors	1/4 oz. 40c. .15

	Pkt.
<b>CERASTIUM tomentosum</b> (Snow-in-Summer). H.P. A dwarf, white-leaved edging plant with small white flowers. Good rock plant. 6 in.	
	1/8 oz. 75c. \$0.25
<b>CHELONE barbata.</b> H.P. Long racemes of scarlet flowers. 2 ft.	
	1/4 oz. 50c. .15
<b>CHEIRANTHUS allioni</b> (Alpine Wallflower). H.H.P. Excellent for rockery or border; brilliant orange flowers. 9 in. Very fragrant	
	1/4 oz. \$1.00 .25
<b>linifolius.</b> This charming lilac Wallflower is seldom out of flower. Valuable for hardy borders and rock gardens. 12 in.	
	.25
<b>CHINESE FORGET-ME-NOT</b> (See <i>Cynoglossum amabile</i> ).	
<b>CHRYSANTHEMUM, Annual Varieties.</b> Showy, hardy annuals of easiest cultivation, blooming from July until frost. 12 to 18 in.	
coronarium, White Pearl. Fine for cutting.	1/4 oz. 35c. .10
—Primrose Queen	1/4 oz. 35c. .10
—Double White. 3 ft.	1/4 oz. 35c. .10
—Double Yellow. 3 ft.	1/4 oz. 35c. .10
—Double Mixed. 3 ft.	1/4 oz. 35c. .10
—Golden Glory. Single deep canary flowers on two-foot stems. 3 ft.	.25
tricolor, Lord Beaconsfield. White and rose	1/4 oz. 35c. .10
—Evening Star. Yellow petals, dark disc	1/4 oz. 35c. .10
—Morning Star. Large primrose flowers	1/4 oz. 35c. .10
—Northern Star. Large ivory white flowers with sulphur zone	1/4 oz. 50c. .10
—Single. Finest mixed	1/4 oz. 35c. .10
—Double-fringed Mixed. Very graceful double flowers.	1/4 oz. 35c. .10
Collection of six varieties. Annual	.50
<b>CHRYSANTHEMUM, Perennial Varieties.</b>	
<b>frutescens.</b> (The White Paris Daisy). Charming plant for greenhouse or Summer bedding outdoors. 18 in. 1/8 oz., 50c.	
Marshall's Double Fall Flowering. Early fall flowering hybrids for open border, in a fine range of colors	.25
maximum, Shasta Daisy. Large white flowers, golden center. June. 2 ft.	.15
—King Edward VII. Very large handsome pure white flowers. 2 1/2 ft. July.	.25
Giant White Double Shasta Daisy. Flowers 5 in. in diameter resembling Asters	.50

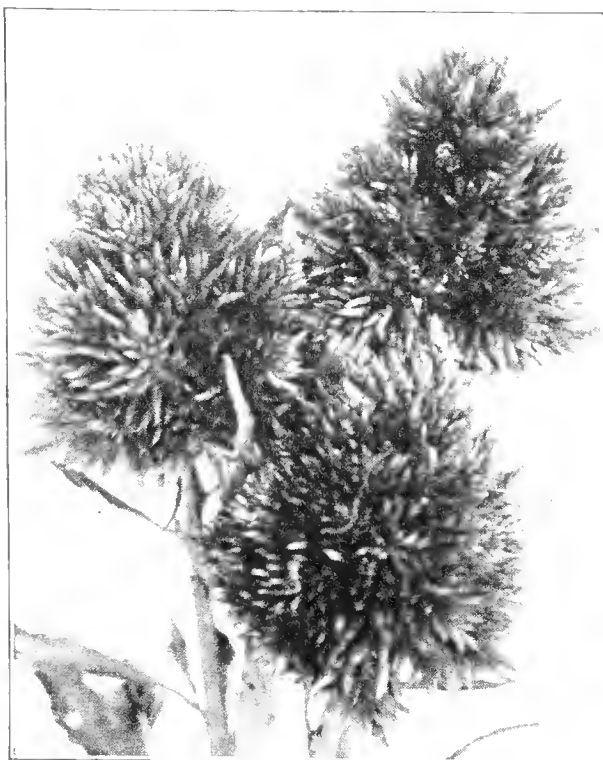

Celosia Childsi



Centaurea Montana



Centaurea Cyanus, Mixed

- CINERARIA hybrida.** G.P. One of the most gorgeous colored flowering plants for either greenhouse or conservatory. Seeds should be sown in July, August, or September. Pkt.
- Marshall's Matchless Prize Mixed.** This wonderful strain, grown for us by a German specialist, produces enormous flowers in large compact trusses. An excellent exhibition strain. 24 in. .... \$0.50
- grandiflora, Matchless Dwarf Prize Mixed.** This strain is just as choice as above, but different in height. 18 in. .... .50
- Cactus-flowered Mixed.** Large flowers with narrow rolled petals radiating from the center. Fine for conservatory. 2 ft. .... .50
- hybrida multiflora nana.** The dwarfiest and most compact strain, with large flowers. 9 in. .... .50
- stellata.** Tall, pyramidal plants, bearing star-like flowers. Very effective for the house and conservatory, also very useful for cutting. 2 ft. Mixed Colors .... .50
- maritima candidissima.** H.H.P. A white-leaved "Dusty Miller," used for edging. 1 ft. .... ¼ oz. 50c .15
- CLARKIA.** H.A. This pretty and easily grown annual does well either in sun or shade. 2 ft.
- Brilliant.** Double salmon-scarlet flowers. .... ¼ oz. 50c. .15
- Purple Prince.** Rich ruby-purple, double flowers. ¼ oz. 50c. .15
- rosea flore pleno.** Double rose .... ¼ oz. 50c. .15
- Salmon Queen.** Extra double, salmon-pink .... ¼ oz. 50c. .15
- Scarlet Queen.** Fine double, brilliant salmon-orange-scarlet. .... ¼ oz. 50c. .15
- White.** Very double, pure white flowers .... ¼ oz. 50c. .15
- Double Mixed.** All colors .... ¼ oz. 35c. .10
- CLEOME gigantea** (Giant Spiderflower). H.A. Bright rosy crimson flowers; adapted for large beds or borders. 3½ ft. .... ¼ oz. 50c. .10
- CLIANTHUS Dampieri.** G.P. (Austrian Glory Pea). Scarlet flowers .... .25
- CLERODENDRON fallax.** G.P. Erect growing greenhouse plant, with large spikes of scarlet flowers .... .50
- COBAEA scandens.** H.A.C. Tender climber, large, bell-shaped blue flower. 20 ft. .... ¼ oz. 50c. .10
- White.** Large, white, bell-like flowers .... ¼ oz. 60c. .15
- COCKSCOMB.** (See *Celosia cristata*).
- COLEUS, Marshall's Matchless Mixed.** G.P. Richly colored foliage plants .... .25
- thyrsoides.** Flowers light blue, borne in panicles; fine leaves. An excellent greenhouse plant. 18 in. .... .75
- COLLINSIA, Mixed.** Free flowering, hardy annuals of deserved popularity, blooming from June to October, and suited to dry situations .... ¼ oz. 35c. .10
- COLUMBINE.** (See *Aquilegia*.)
- CONVOLVULUS, or Morning Glories.** (See also *Ipomoea*.) H.A.C. D deservedly very popular, as they are of the most free-flowering and rapid growing plants in cultivation, thriving in almost any situation.
- major.** Mixed colors. Climbers of rapid growth. 30 ft. Oz. 30c. .10
- minor, or Bush Morning Glories.** Mixed colors. 12 in. Oz. 30c. .10
- COREOPSIS.** H.P. Long stemmed, large, single flowers. 2 ft. Fine cut flower.
- grandiflora.** Large flowers of rich yellow .... ¼ oz. 50c. .10
- grandiflora fl. pl.** An improved type with large double flowers of deep yellow .... ¼ oz. 75c. .15
- CORN, Rainbow.** H.A. Variegated leaves, striped in green, white and yellow. 5 ft. .... Oz. 50c. .10
- CORNFLOWER.** (See *Centaurea cyanus*.)
- COSMIDIUM, Crown of Gold.** H.A. Similar to Calliopsis. Flowers orange and yellow. Blooms all summer. 2 ft. .... ¼ oz. 35c. .10



Double Crested Early Flowering Cosmos

- COSMOS.** H.A. This is one of our most useful and beautiful Autumn flowers. To get it in bloom early, seed should be sown in May in the open ground where the plants are desired to bloom, and the seedlings allowed to grow and flower without being transplanted. 5 ft. Pkt.
- Double-crested, Early-flowering.** Semi-double flowers in great profusion. 5 ft.
- Crimson King.** Bright red .... ¼ oz. \$1.25. \$0.25
- Pink Beauty.** A lovely shade of pink, crested flowers. .... ¼ oz. \$1.25 .25
- White Queen.** Pure white crested flowers. ¼ oz. \$1.25 .25
- Crested Mixed.** The above colors in mixture. .... ¼ oz. \$1.00 .25
- Sensation.** Extremely early. Pink and white flowers. .... ¼ oz. \$1.00 .25
- Extra Early Giant-flowering.** Flowers 4 to 5 inches across. 4 ft.
- Crimson** .... ¼ oz. 60c. .10
- Pink** .... ¼ oz. 60c. .10
- White** .... ¼ oz. 60c. .10
- Mixed Colors** .... ¼ oz. 50c. .10
- Giant Late-flowering.** Blooms in September and October. 5 ft.
- Lady Lenox.** Pink .... ¼ oz. 50c. .10
- Lady Lenox.** White .... ¼ oz. 50c. .10
- Red** .... ¼ oz. 50c. .10
- Mixed.** All shades .... ¼ oz. 35c. .10
- Klondyke.** Large flowered golden yellow ... ¼ oz. 50c. .10
- hybrida Orange Flare.** Early flowering, brilliant orange. 3 ft. .... ¼ oz. 75c. .15



Cynoglossum Amabile

**COWSLIP, Mixed** (*Primula veris*). H.P. A Spring-flowering plant. Beautiful colors, rich brown, crimson and yellow. 6 in. . . . . \$0.25

**CUPHEA platycentra** (Cigar Plant). H.H.P. Valuable as a bedding and border plant. The flowers are scarlet with a black and white lip. 1 ft. . . . . .15

**CYNOGLOSSUM amabile**. H.A. Beautiful rich blue, sweet-scented flowers. Fine for cutting. 18 in. . . . 1/4 oz. \$1.00 .25  
**amabile, Pink** . . . . . 1/4 oz. \$1.00 .25

**CYPERUS alternifolius** (Umbrella Plant). G.P. Handsome plants easily raised from seed; used for table decorations and combining with palms; semi-woody. 2 ft. . . . . .25

**CYPRESS VINE**. H.A.C. A fast growing annual vine, with feathery, dark-green foliage and star-like flowers. 10 ft.  
**Bright Scarlet** . . . . . 1/4 oz. 35c. .10  
**Finest Mixed** . . . . . 1/4 oz. 35c. .10

**CYCLAMEN**. G.P. These are among the choicest of flowering greenhouse plants. Seed should be sown from August until January.

**Marshall's Giant Show**. The seeds we offer are grown by a specialist in Europe who we believe has the finest strain for exhibition plants

	100	
	Seeds	
Bonfire . . . . .	\$3.00	.50
Bright Red . . . . .	2.50	.50
New Salmon Rose Improved . . . . .	2.75	.50
Orange Beauty . . . . .	3.00	.50
Perle of Zehlendorf. Dark Salmon . . . . .	2.75	.50
Pure White . . . . .	2.50	.50
Pure Rose . . . . .	2.50	.50
Rose of Zehlendorf. Light salmon. . . . .	3.00	.50
Saffron Red . . . . .	3.00	.50
Salmon Scarlet. Christmas color . . . . .	3.00	.50
Soft Rose with Carmine Eye . . . . .	2.50	.50
White with Carmine Eye . . . . .	2.50	.50
Mixture of Above Varieties . . . . .	2.75	.50
New Ruffled. Mixed colors . . . . .	3.50	.50

**DAHLIA**. H.H.P. This popular flower can be easily raised from seed, flowering the same season. Seed should be sown early in gentle heat. 4 to 6 ft. Pkt.

**CALIFORNIA HYBRIDS. Marshall's Gold Medal Seed.**  
 All pedigree hand-picked from selected flowers. Pods ripened on plants.  
 . . . . .25 seeds, \$1.50; 50 seeds, \$3.00; 100 seeds, \$5.00

- Cactus**. New choice varieties. Mixed colors. . . . . \$0.50
- Coltness Hybrids**. Single varieties in many colors, growing from 18 to 24 inches in height . . . . . .50
- Coltness Yellow**. Clear yellow . . . . . .50
- Coronata**. Sweet scented, orange, scarlet on outer petals . . . . . .50
- Mignon Mixed**. English dwarf . . . . . .50
- Pompon**. Saved from the best named varieties . . . . . .50
- Double, Large-Flowering**. Double mixed colors . . . . . .25
- Single, Large-Flowering**. Single mixed colors . . . . . .25
- Unwin's Dwarf Hybrids**. Semi-double. 2 ft. . . . . .25

**DAISY, Double**. (See *Bellis perennis*).

**DAISY, Single**. (See *Chrysanthemums*).

**DATURA** (Trumpet Flower). H.H.A. Robust garden annual, bearing large trumpet-shaped flowers. 4 ft.

**Double-flowering** (*Fastuosa fl. pl.*). Mixed . . . . 1/4 oz. 40c. .10

**Cornucopia** (Horn of Plenty). Flowers white and purple. . . . . 1/4 oz. 40c. .10

**DELPHINIUM** (Larkspur). H.P. Delphiniums are hardy and can be grown in any garden. They are handsome plants for the herbaceous border and shrubbery and are splendid for cut flower use.

**Belladonna**. Improved. Light azure blue. . . . 1/8 oz. \$1.00 .25

**Belladonna, Fanny Stormonth**. Light azure blue. . . . . .50

**Blue Butterfly**. Graceful spikes of large azure-blue flowers. . . . . 1/4 oz. 75c. .15

**Bellamosa**. Improved. An improved *Formosum* which is not subject to mildew. Dark blue in color . . . . 1/8 oz. \$1.00 .25

**chinensis album**. Pure white. 2 to 3 ft. . . . . 1/4 oz. 75c. .10

**chinensis azureum**. Azure blue. 2 to 3 ft. . . . 1/4 oz. 75c. .10

**chinensis, mixed** (*grandiflorum*). Shades of blue and pure white. 2 to 3 ft. . . . . 1/4 oz. 50c. .10

**Iceberg**. White flowers, of the *elatum* class . . . . . .50

**Blackmore & Langdon's Hybrids**. A superior imported strain and contains a mixture of exceptionally choice flowers ranging in color from light blues through mauves and lavenders to deepest ultramarine. 5 ft. . . . . .50

**Marshall's Matchless Hybrids**. Choice show hybrids, saved from the best named varieties . . . . . 1/8 oz. \$1.00 .25

**Wrexham or Hollyhock Hybrids**. Experts regard this strain as quite the finest in cultivation. It is conspicuous for its massive, broad-based spires of large individual flowers which are compactly arranged about the stems. The shades of blues and mauves are of exquisite clarity. Particularly effective in mass plantings with *Lilium candidum*. 4 to 6 ft. . . . . 1/16 oz. \$5.00 2.00

**DIANTHUS** (Chinese or Indian Pinks). H.H.A. These, although biennials, bloom the first season, and should be treated as hardy annuals. They flower early in Summer and continue until frost. They are excellent for small beds or edgings, flowering profusely and in great variety of colors. 12 in.

**Single Annual Pinks.**

**Heddewigi**. Large, attractive flowers of most brilliant colors. Finest Mixed . . . . . 1/4 oz. 50c. .10

**laciniatus, Single Mixed**. Fringed flowers of all colors. . . . . 1/4 oz. 50c. .10

**Double Annual Pinks.**

**chinensis fl. pl.** (Chinese Pink). Large, double flowers in unlimited variety of colors. Finest Mixed. . . . 1/4 oz. 50c. .10

**diadematus fl. pl.** (Double Diadem Pink). Large, double flowers. Mixed . . . . . 1/4 oz. 50c. .10

**Heddewigi fl. pl.** (Japanese Pink). Large, double flowers of exquisite colors. Finest Mixed . . . . . 1/4 oz. 50c. .10

**Fireball**. Large double, brilliant red . . . . . 1/4 oz. 75c. .15

**Pink Beauty** (Heddewigi). A beautiful double pale pink annual variety . . . . . 1/4 oz. \$1.25 .25

**laciniatus, Salmon King**. Very striking double flowers, rich salmon-scarlet . . . . . 1/4 oz. \$1.00 .15

**Snowball**. Extra large, double, pure white . . . . 1/4 oz. 75c. .15

**laciniatus fl. pl.** Double-fringed flowers; beautifully striped. Mixed . . . . . 1/4 oz. 75c. .15

**Collection of Double Annual Pinks**. Six varieties . . . . . .60

**Sweet Wivelsfield**. A great variety of color and long season of blooming. 12 in. . . . . 1/4 oz. \$1.25. .25

DIANTHUS—Continued. Pkt.

**Hardy Perennial Pinks.**

- Caesius (Cheddar Pink). Pink, free flowering .....\$0.25
- Deltoides (Maiden Pink). Deep rose. 8 in. .... .25
- plumarius fl. pl., Pheasants-eye. Pretty, fringed double flowers ..... ¼ oz. 75c. .15
- plumarius semperflorens (Perpetual Pink). Mixed, single and double ..... ⅓ oz. \$1.00 .25

- DICTAMNUS fraxinella. H.P. Handsome spikes of reddish flowers and fragrant leaves. 3 ft. .... ¼ oz. 75c. .15
- fraxinella albus. White variety ..... ¼ oz. 75c. .15

- DIDISCUS caeruleus (Blue Lace Flower). H.A. An attractive annual, blooming from July until frost. Pale lavender flowers, valuable for cutting. 18 in. .... ¼ oz. .50c. .15

**DIGITALIS or FOXGLOVE.** H.P. Producing long spikes of tubular flowers. Used extensively with good effect for naturalizing in shrubberies and half-shady places. 3 ft.

- Marshall's Superb Purple ..... ¼ oz. 50c. .10
- Marshall's Superb Rose ..... ¼ oz. 50c. .10
- Marshall's Superb Yellow, Isabellina ..... ¼ oz. 75c. .15
- Marshall's Superb White ..... ¼ oz. 50c. .10
- Marshall's Superb Mixed ..... ¼ oz. 35c. .10
- Giant Shirley Hybrids. These hybrids are very large in size and vigor, growing from 5 to 6 ft. .... ¼ oz. \$1.25 .25

**DIMORPHOTHECA** (African Daisy). H.A. Daisy-like flowers. 18 in.

- aurantiaca. Orange, dark disc ..... ¼ oz. 50c. .10
- Salmon Beauty ..... ¼ oz. \$1.00 .25
- White Beauty ..... ¼ oz. \$1.00 .25
- aurantiaca, Hybrids ..... ¼ oz. 75c. .15
- Eklonis. Large, star-shaped pure white flowers with a small blue disc. 2 ft. .... .25



Didiscus Caeruleus



Dimorphotheca—African Daisy

- DOLICHOS or HYACINTH BEAN. H.A.C. Annual climbers with clusters of Bean-like flowers. 10 ft. Pkt
- lablab, Mixed. Purple and white. .... Oz. 40c. \$0.10
- DORONICUM caucasicum. H.P. Yellow daisy-like flowers, very early ..... .50
- DRACAENA indivisa. G.P. For vases, pots, etc. Narrow green leaves ..... ¼ oz. 50c. .10
- ECHINOCYSTIS lobata (Wild, or California Cucumber). H.A.C. The fastest growing annual vine in existence; grows 20 feet in six weeks. Pretty foliage and inconspicuous white flowers ..... oz. 50c. .10
- ECHINOPS ritro (Blue Globe-thistle). H.P. Purple. .... ¼ oz. 50c. .10
- EDELWEISS (Leontopodium). H.P. Silvery white everlasting flowers, fine for rock gardens. 6 in. .... .25
- EREMURUS (Gold Medal Hybrids). H.P. Stately plant with long spikes of flowers. 8 ft. .... .50
- ERIGERON speciosus (The Midsummer Daisy). H.P. Pale mauve flowers with golden centers. Fine for cutting. 18 in. .15
- ERYSIMUM arkansanum. H.A. Bright yellow flowers resembling the Wallflower. 18 in. .... .15
- pulchellum. H.P. Pale yellow flowers. Useful for rackwork 9 in. .... .15
- ERYNGIUM amethystinum (Sea Holly). H.P. Spiny foliage and small, amethyst-blue flowers in large panicles. 3 ft. .... ⅓ oz. \$1.00 .15
- ERINUS alpinus. H.P. Bright purple flowers, a choice rock plant. 6 in. .... .50
- EUCALYPTUS globulus (Blue Gum Tree). G.P. Used as greenhouse plant for decorations ..... .15
- EUPATORIUM Fraseri. H.P. White, fine for cutting. 2 ft. .... ¼ oz. \$1.00 .15
- purpureum. Purple-blue. Aug. to Oct. .... ⅓ oz. \$1.50 .25
- EUPHORBIA heterophylla (Fire-on-the-Mountain). H.A. Leaves large and glossy green, often tipped with orange-scarlet. 3 ft. .... ⅓ oz. 50c. .15
- variegata (Snow-on-the-Mountain). White and green bracts, excellent for bouquets. 2 ft. .... ¼ oz. 35c. .10



Gerbera Jamesoni Hybrid

**GEUM.** H.P. Showy, hardy perennial of easy culture and well adapted for the flower garden; fine for cutting. 2 ft. Pkt.  
**atrosanguineum, fl. pl.** Large, double crimson flowers ..... 1/4 oz. 50c. \$0.10  
**Lady Stratheden.** Double yellow..... 1/8 oz. 75c. .15  
**Mrs. Bradshaw.** Double orange-scarlet flowers; very large and full. 1/8 oz. 75c. .15  
**Orange Queen.** A beautiful shade of orange..... .25  
**GILIA capitata.** H.A. A very graceful annual with lavender-blue flowers. 1/4 oz. 35c. .10

**GODETIA.** H.A. Bushy annual, with showy large flowers. They grow quickly, bloom abundantly, and are excellent for beds and borders. The double varieties are splendid for cutting. 18 in.

**Brilliant.** Glowing carmine. Single ..... 1/4 oz. 35c. .10  
**Double Rose.** A delicate rose-pink ..... 1/4 oz. 50c. .10  
**Duchess of Albany.** Single. Satiny-white ..... 1/4 oz. 35c. .10  
**Gloriosa.** Compact, brilliant blood-red. Single ..... 1/4 oz. 35c. .10  
**Rosy Morn.** A lovely coral-pink, very double flowers ..... 1/4 oz. 75c. .10  
**Finest Mixed Colors.** Single ..... Oz. 60c. .10

**GLOBE-AMARANTH (Gomphrena).** H.A. Clover-like heads of flowers; esteemed as everlasting. 12 in.

**globosa alba.** White ..... 1/4 oz. 35c. .10  
**globosa rubra.** Purple ..... 1/4 oz. 35c. .10  
**globosa.** Mixed colors..... 1/4 oz. 35c. .10

**GLOXINIA.** G.P. Charming pot plants, flowering in Summer in greenhouse or window.

**Marshall's Matchless.** Erect, giant flowering, mixed. Saved from choicest erect flowering sorts. A grand variety of colors ..... .50

**GOMPHRENA.** (See Globe-Amaranth.)

**GOURDS.** H.A.C. Thrifty annual climbers bearing "Ornamental Gourds." 10 ft.

**Apple-shaped.** Small fruit, striped yellow and dark green ..... Oz. 40c. .10  
**Bottle-shaped.** Fruit yellowish-white and dark green. Oz. 40c. .10  
**Calabash, or African Pipe Gourd.**..... Oz. 50c. .10  
**Dipper-shaped** ..... Oz. 40c. .10  
**Dish cloth (Chinese Loofa, or Sponge Gourd).** Large, elongate fruit; spongy inside. Flowers deep golden yellow. .... Oz. 40c. .10  
**Egg.** Fruit white, resembles eggs. .... Oz. 40c. .10  
**Hercules' Club.** Enormous fruit, often 4 ft. long, thicker at the base ..... Oz. 50c. .10  
**Mock Orange, or Orange-shaped.**..... Oz. 50c. .10  
**Pear-shaped.** Very pretty striped fruit..... Oz. 50c. .10  
**Sugar Trough** ..... Oz. 50c. .10  
**Mixed Ornamental Varieties.**..... Oz. 40c. .10  
**Collection of Ten Varieties of Gourds.**..... .75

**ESCHSCHOLTZIA or CALIFORNIA POPPY.** H.A. Very attractive annuals for beds, edgings, masses; profuse flowering; fine cut, glaucous foliage; blooms from June to frost. 12 in. Pkt.

**aurantiaca.** True California Poppy. Orange .... 1/4 oz. 30c. \$0.10  
**californica alba.** White ..... 1/4 oz. 30c. .10  
**Carmine King.** Beautiful deep red ..... 1/4 oz. 35c. .10  
**Chrome Queen.** A beautiful clear chrome yellow. 1/4 oz. 50c. .10  
**Crimson King.** Beautiful crimson-scarlet ..... 1/4 oz. 30c. .10  
**Golden West.** Large flowers of deep yellow shade. 1/4 oz. 35c. .10  
**Mandarin.** Large, scarlet, inside orange ..... 1/4 oz. 35c. .10  
**Rose Queen.** Rosy pink ..... 1/4 oz. 50c. .10  
**The Geisha.** Petals prettily fluted. Color inside golden and outside intense orange-crimson. Very beautiful. .... 1/4 oz. 50c. .10  
**Single Mixed.** All colors ..... oz. 75c. .10

**FERNS, Greenhouse Variety.** Mixed. G.P. .... Pkt. \$0.35

**FORGET-ME-NOT.** (See MYOSOTIS.)

**FOXGLOVE.** (See DIGITALIS.)

**FOUR O'CLOCKS.** (See MARVEL OF PERU.)

**FRANCOA ramosa alba.** H.B. Elegant sprays of pure white flowers. 2 ft. .... .25

**FREESIA, New Hybrids Mixed.** G.P. Shades of pink, red, violet, yellow, etc. .... .25

**GAILLARDIA.** H.A. Showy garden annuals; they flower uninterruptedly from early summer until frost; the flowers are of large size and afford charming tints in their colors. 2 ft.

**amblyodon.** Blood-red ..... 1/4 oz. 35c. .10  
**Indian Chief.** An improved single. Bronze-red..... 1/4 oz. 75c. .15  
**pecta Mixed, Single.** Annuals..... 1/4 oz. 35c. .10  
**lorenziana, Double Mixed.** Annuals..... 1/4 oz. 35c. .10  
**Portola Hybrids.** H.P. Varied shades of red-tipped golden. Long stiff stems ..... 1/4 oz. \$1.00. .25  
**Marshall's Matchless Hybrids.** H.P. A grand new improved strain; enormous flowers and very strong habit..... 1/8 oz. 75c. .25

**GALEGA officinalis.** H.P. A hardy plant producing a number of blue, miniature, pea-like flowers in sprays throughout the summer. 3 ft. .... 1/4 oz. 35c. .10  
**officinalis alba.** White flowers ..... 1/4 oz. 35c. .10

**GAURA lindheimeri.** H.P. Graceful spikes of rosy white flowers 3 ft. .... 1/4 oz. 50c. .10

**GAZANIA longiscapa.** H.A. Flowers golden yellow with brown ring. 12 in. .... .15

**GENTIANA acaulis.** Gentian-blue alpine, most desirable. 4 in. .... .25

**GERANIUM.** G.P. Well-known plants for garden or pot culture.  
**zonale.** Finest mixed ..... .15

**GERBERA Jamesoni hybrida (The Transvaal Daisy).** H.H.P. Fine for cut flowers or bouquets. 18 in. .... 100 seeds, \$1.00 .25



Geum, Mrs. Bradshaw



**GRASSES, ORNAMENTAL.** A most valuable class of plants for the lawn, shrub bed, border, or tropical bed. The perennial varieties, many of which have variegated foliage, are excellent. The annual sorts are particularly pretty on account of the graceful, feathery flower panicles.

**Agrostis nebulosa.** H.A. Very graceful and pretty. 18 in. . . . \$0.10  
**Briza maxima** (Quaking Grass). H.A. Very pretty. 18 in. . . . 10  
**Coix lachryma** (Jobs-tears). H.A. Foliage quite broad. Seeds prominent, very large and shiny. 3 ft. . . . . 10  
**Erianthus ravennae.** H.P. Silvery plumes, resembling Pampas Grass. 8 ft. . . . . 10  
**Eulalia zebrina.** H.P. White striped foliage, very ornamental. 4 ft. . . . . 1/4 oz. 35c. 10  
**Gynerium argenteum** (Pampas Grass). H.P. Beautiful silvery plumes. 10 ft. . . . . 1/4 oz. 35c. 10  
**Hordeum jubatum.** (Squirrel-tail Grass). H.A. A pretty variety, with bushy panicles of flowers. 3 ft. . . . . 10  
**Pennisetum longistylum.** H.A. Annual grass, gracefully drooping heads. 2 ft. . . . . 1/4 oz. 35c. 10  
**Pennisetum ruppelianum.** H.P. Hardy perennial grass, growing 3 ft. high with violet-tinted silvery plumes. The deep green foliage is long and slender . . . . . 1/4 oz. 35c. 10

**GREVILLEA robusta** (Silk Oak). G.P. Graceful foliage plant. 4 ft. . . . . 1/4 oz. 50c. 10

**GYPSOPHILA** (Baby's Breath). H.A. Extremely useful for bouquets. Flowers small and come in delicate sprays and panicles.

**elegans alba grandiflora.** An improved large flowering, pure white form of the annual Baby's Breath. . . . . Oz. 50c. 1/4 lb. \$1.50 10  
**elegans carminea.** Carmine rose . . . . . Oz. 60c. 10  
**rosea grandiflora.** Delicate rose . . . . . Oz. 60c. 10  
**muralis.** Bright rose . . . . . 1/4 oz. 35c. 10  
**pacifica.** Rose-colored perennial "Baby's Breath" . . . . . 25  
**paniculata.** H.P. One of the finest for cutting. Pure white flowers, very small and borne in large panicles. 2 ft. . . . . 1/4 oz. 35c. 10  
**paniculata flore pleno.** H.P. A double-flowering variety, pure white. 2 ft. . . . . 1/8 oz. \$1.00 25

**HELENIUM.** H.P. Striking hardy plants, very useful for decorating.

**autumnale superbum.** Golden yellow . . . . . 15  
**Riverton Gem.** Yellow, changing to red. Long stems. 5 ft. . . . . 1/8 oz. \$1.00 15

**HELIANTHUS.** (See Sunflower.)

**HELICHRYSUM, or STRAWFLOWER.** H.A. Large, double "everlasting" flowers. 2 ft.

**maestrosium, Fire Ball.** Double red . . . . . 1/4 oz. 50c. 10  
**Golden Globe.** Double yellow . . . . . 1/4 oz. 50c. 10  
**Rose Queen** . . . . . 1/4 oz. 50c. 10  
**Salmon** . . . . . 1/4 oz. 50c. 10  
**Silver Globe.** Glistening white . . . . . 1/4 oz. 50c. 10  
**Violet** . . . . . 1/4 oz. 50c. 10  
**Large Flowering, Double, Mixed Colors** . . . . . 1/4 oz. 35c. 10  
**Collection.** Packet each 6 colors . . . . . 50

**HELIOPHILA leptophylla.** H.A. For pots or borders. Bright blue flowers. 18 in. . . . . 25

**HELIOTROPE.** G.P. Well-known fragrant flowering plants for pots or gardens.

**Marshall's Blue Perfection.** Dark blue . . . . . 1/4 oz. \$2.00 25  
**Queen Helen.** Light blue . . . . . 1/4 oz. \$1.00 15  
**White Lady.** A popular white variety . . . . . 15  
**Lemoine's Giant Hybrids. Mixed** . . . . . 1/4 oz. \$1.00 15

**HESPERIS.** (See Rocket.)

**HEUCHERA sanguinea splendens.** H.P. Long spikes of fiery red flowers. 18 in. . . . . 15  
**sanguinea hybrida.** H.P. Fine for borders. 18 in. Mixed colors . . . . . 25

**HIBISCUS.** Showy plants of vigorous growth.

**africanus.** H.A. Yellow with black center. 18 in. . . . 1/4 oz. 35c. 10  
**Marshall's Rainbow grandiflorus hybrids.** H.P. New giant Marshmallows. Very large flowers, various colors. 5 ft. . . . . 1/4 oz. 75c. 15  
**moscheutos.** (Swamp Rose Mallow). H.P. Flowers of a light rosy-red, with dark center. 4 ft. . . . . 1/4 oz. 50c. 10

**HOLLYHOCKS.** H.P. One of the showiest of hardy garden plants. No garden is complete without these stately flowers. Hollyhocks are troubled of late with a rust, which can be prevented if plants are sprayed frequently in early Spring with Bordeaux mixture. 6 ft.

**Marshall's Giant.**

**Double Apple Blossom** . . . . . 1/8 oz. 50c. \$0.15  
**Newport Pink** . . . . . 1/8 oz. 50c. 15  
**Pink Queen.** Salmon-pink . . . . . 1/8 oz. \$1.00 15  
**Double Scarlet** . . . . . 1/8 oz. 50c. 15  
**Double Deep Rose** . . . . . 1/8 oz. 50c. 15  
**Double Sulphur Yellow** . . . . . 1/8 oz. 50c. 15  
**Double White** . . . . . 1/8 oz. 50c. 15

**Chater's Extra Choice, Double Mixed Colors** . . . . 1/8 oz. 75c. 15  
**Collection of Double Hollyhocks, 6 colors** . . . . . 75  
**Marshall's Giant Single Mixed** . . . . . 1/4 oz. 50c. 10

**HONESTY.** (See *Lunaria biennis.*)

**HUMULUS japonicus** (Japanese Hop). H.A.C. A climber with dense green foliage; 20 ft. . . . . 1/4 oz. 35c. 10  
**japonicus fol. variegatus.** Variegated foliage . . . 1/4 oz. 35c. 10

**HUNNEMANNIA fumoriaefolia** (Giant Yellow Tulip Pappy). H.A. Flowers are tulip-shaped, pure golden yellow. When cut and put in water they will last a full week. 2 ft. . . . . 1/4 oz. 50c. 10

**HYACINTH-BEAN.** (See *Dolichos.*)

**IBERIS.** (See *Candytuft.*)

**ICE PLANT.** (See *Mesembryanthemum crystallinum.*)



Hibiscus, Morsholl's Roimbow Hybrids

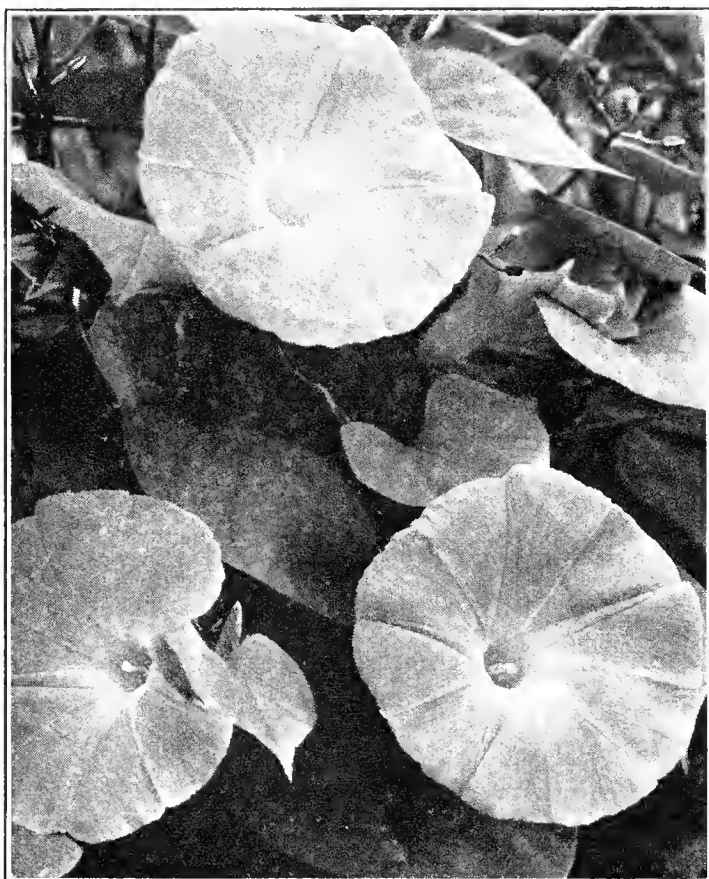

Morning Glory, Heavenly Blue

- IMPATIENS** (Sultan's or Zanzibar Balsam). G.P. Charming plants for decoration of the greenhouse or table, producing waxy looking flowers profusely and continuously. 2 ft. Pkt.
- sultani.** Flowers of brilliant rosy-scarlet color. . . . . \$0.25
  - holsti Hybrids.** Form strong, bushy plants covered with attractive flowers. As pot plants they bloom the year round. Choicest mixed colors . . . . . .25
- INCARVILLEA Delavayi.** H.P. The flowers are borne on long, stout stems, tube-shaped. Color bright rose. 2 ft. . . . . .25
- IONOPSIDIUM acule.** H.H.P. Pale mauve flowers adapted for rockeries and carpet bedding; very dwarf habit. 4 in. . . . . .15
- IPOMOEA** (Morning Glory). (See also **Convolvulus**). H.A.C. Climbers of rapid growth, with beautiful and varied flowers; for covering walls, trellises, arbors or stumps of trees they are invaluable. 20 ft.
- cardinalis** (Cardinal Climber). A rapid growing annual, with deep cordinal-red flowers and lacinated foliage. . . . . 1/4 oz. 75c. .10
  - grandiflora alba** (Moonflower). Large, heart-shaped leaves and large, pure white flowers, which open only late in the evening . . . . . oz. 75c. .10

**rubro-caerulea** (Heavenly Blue). Beautiful, large sky-blue flowers, one of the best morning glories. Selected strain . . . . . 1/2 oz. 75c. .15

- setosa** (Brazilian Morning-glory). Large, ornamental foliage, with bright rose flowers . . . . . 1/4 oz. 30c. .10
  - Imperial Japanese, Mixed.** A great improvement over the old-fashioned sorts . . . . . oz. 50c. .10
- KENILWORTH IVY.** H.H.P. Neat trailer for rock garden. Small snapdragon-like flowers. Attractive foliage, 6 in. . . . . .15
- KOCHIA tricophylla** (Belvedere; Summer Cypress, or Mexican Firebush). H.A. Grows in a perfectly pyramidal shaped cypress bush, with small, feathery, light-green foliage. Becomes a lovely crimson hue about September. 2 1/2 ft. . . . . 1/4 oz. 35c. .10
- KUDZU VINE** (Pueraria Thunbergiana). H.P. A splendid climber for covering permanent verandas, dead trees, etc. Large green foliage and pea-shaped blossoms. . . 1/4 oz. 50c. .10

- LANTANA.** G.P. One of the most desirable greenhouse or bedding plants; constantly in bloom. 2 ft. Newest hybrids, mixed . . . . . 1/4 oz. 75c. \$0.15 Pkt.
- LATHYRUS latifolius, Perennial Sweet Pea.** H.P. Hardy climbers. Fine for cutting. 6"ft.
- latifolius.** Purplish red . . . . . 1/2 oz. 50c. .10
  - White Pearl.** A large flowering, robust growing variety of the above . . . . . 1/2 oz. 50c. .10
  - Pink Beauty.** Rosy pink . . . . . 1/2 oz. 50c. .10
  - Finest Mixed.** All colors . . . . . 1/2 oz. 30c. .10
- LARKSPUR.** H.A. Elegant and ornamental plants, producing in great variety of form some of the most beautiful flowers in cultivation.
- Marshall's Invincible Branching.** Double flowers; excellent for cutting. Offered in the following choice of colors. 3 ft.
- Azure Blue** . . . . . 1/4 oz. 50c. .15
  - Dark Blue** . . . . . 1/4 oz. 50c. .15
  - Carmine** . . . . . 1/4 oz. 50c. .15
  - Flesh Color** . . . . . 1/4 oz. 50c. .15
  - Rose** . . . . . 1/4 oz. 50c. .15
  - White** . . . . . 1/4 oz. 50c. .15
  - Finest Mixed** . . . . . 1/4 oz. 40c. .15
- Collection Invincible Branching, 6 Varieties** . . . . . .75
- Blue Spire.** Oxford blue . . . . . 1/4 oz. \$1.00 .25
  - Carmine King.** Deep carmine-rose . . . . . 1/4 oz. \$1.00 .25
  - Exquisite Pink Improved.** Soft rose-pink . . . . . 1/4 oz. 75c. .25
  - La France.** Lovely salmon-pink . . . . . 1/4 oz. 75c. .25
  - White Spire.** Pure white . . . . . 1/4 oz. \$1.00 .25
  - Tall Rocket.** Mixed. Long showy spikes . . . . . 1/4 oz. 35c. .10
- LAVATERA splendens rosea** (Pink Mallow). H.A. Bushy plants, produce large, open, pink, mallow-like flowers in great profusion. 3 ft. . . . . 1/4 oz. 50c. .10
- splendens alba.** Large, glossy white flowers . . . 1/4 oz. 50c. .10
  - Finest Mixed Colors** . . . . . 1/4 oz. 50c. .10

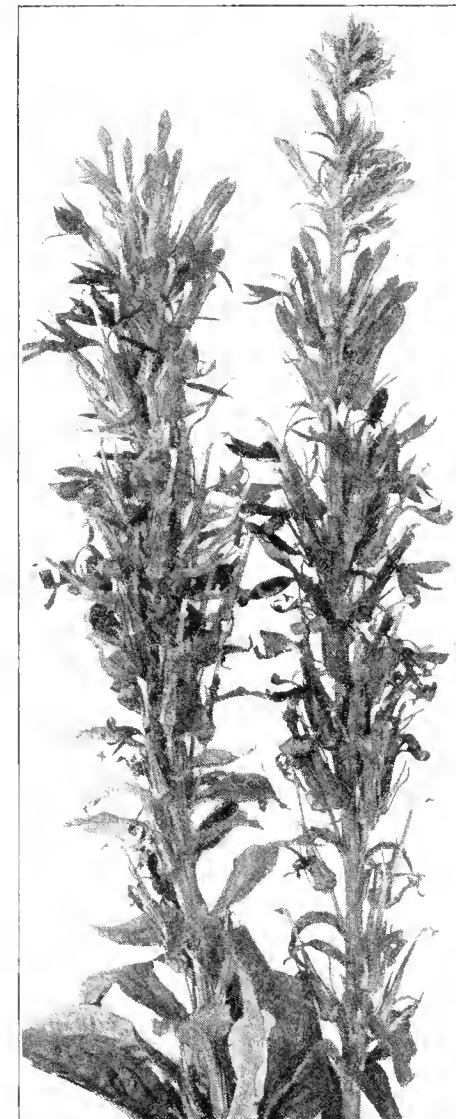

Lobelia Cardinalis

- LEMON VERBENA.** (See **Verbena**.)
- LEPTOSYNE maritima.** H.A. Large lemon-yellow Marguerite-like flowers on tall stalks. 3 ft. Pkt., 15c; 1/4 oz., 75c.
- Stillmanni.** Golden yellow flowers. Pkt., 25c; 1/4 oz., \$1.00.
- LIATRIS pycnostachya.** (Blazing Star). H.P. Long spikes of purple and rosy-purple flowers. 3 ft. Pkt., 25c.
- LILY Seeds—**  
List on request
- LINARIA cymbalaria.** (See **Kenilworth Ivy**.)
- LINARIA.** H.A. Very showy annual resembling Snap-dragon. Used extensively as a winter cut flower in greenhouses. 1 ft.
- Choice Mixed Varieties.** Pkt., 25c.
- LINUM.** H.A. Free-flowering plant for borders.
- flavum.** H.P. Golden yellow. 1 ft. Pkt., 25c.
  - grandiflorum rubrum.** Single scarlet flowers 12 in. 1/4 oz. 25c; pkt., 10c.
  - perenne.** H.P. Blue flowers. 18 in. 1/4 oz., 35c; pkt., 10c.

Pkt.

**LOBELIA**. H.H.A. Bushy plants, with pendent branches; very profuse flowering. Fine for baskets or edging borders. 6 in.

**Marshall's Compact**. The finest dark blue Lobelia; the plants are compact, covered with a profusion of bloom..... 1/16 oz. \$1.00. \$0.25

**erinus compacta, Crystal Palace**. Dark blue.... 1/8 oz. \$1.00 .10

**Emperor**. Light blue..... 1/8 oz. 75c. .10

**erinus speciosa**. Bright blue..... 1/8 oz. 50c. .10

**gracilis**. Light blue, trailing..... 1/8 oz. 50c. .10

**Mixed Colors** ..... 1/8 oz. 50c. .10

**tenuior** (Romosa). Upright habit with large blue flowers; adapted for pots or borders..... .25

**Perennial Varieties:**

**cardinalis** (Cardinal Flower). A native variety, with spikes of scarlet flowers; fine border plant. 3 ft..... .25

**LOVE-LIES-BLEEDING.** (See *Amaranthus*).

**LOVE-IN-A-MIST.** (See *Nigella*).

**LUNARIA biennis** (Honesty). H.B. Attractive flowers followed by decorative seed pods which, when dried may be used for winter decoration. 2 ft..... 1/4 oz. 50c. .10

**LUPINUS**. Free flowering plants, with long spikes of flowers. The Annual and Perennial varieties are among the most useful of our garden flowers, either for mixed borders or house decorations. 2 ft.

**Hartwegi Giants**. Have base branching habits with four and six spikes. Excellent for forcing.

**Giant King White** ..... 1/2 oz. \$1.50 .25

**Giant King Blue** ..... 1/2 oz. \$1.50. .25

**Hartwegi Giants or King Mixed** ..... 1/2 oz. \$1.00 .15

**Hartwegi Blue**. A delicate shade ..... 1/2 oz. 30c. .10

**White**. Splendid for cutting ..... 1/2 oz. 30c. .10

**roseus**. Rose ..... 1/2 oz. 30c. .10

**Tall Mixed, Annual Varieties** ..... oz. 50c. .10

**Perennial Varieties:**

**polyphyllus albus**. White ..... 1/4 oz. 35c. .10

**—caeruleus**. Blue ..... 1/4 oz. 35c. .10

**—Golden Spire**. Golden yellow ..... 1/4 oz. \$2.00 .25

**—roseus**. Rose ..... 1/4 oz. 50c. .15

**Snow Queen**. (Tree Lupine.) A grand variety; pure white. .... 1/4 oz. 75c. .15

**Mixed Perennial Varieties** ..... 1/4 oz. 25c. .10

**Marshall's Matchless Hybrids**. Comprising a wonderful range of colors among perennial Lupines ..... 1/4 oz. \$1.00 .25

**LYCHNIS chalconica**. H.P. The old favorite Scarlet Lychnis. 18 in. .... 1/4 oz. 75c. .10

**Arkwrighti**. Large brilliant flowers, color from orange-scarlet to soft salmon-pink ..... 1/8 oz. 75c. .25

**Haageana Hybrids, Mixed Colors**. Bushy little plants. 12 in. .... 1/8 oz. 75c. .15

**viscaria splendens**. Brilliant scarlet ..... 1/4 oz. 75c. .10

**MALOPE grandiflora**. H.A. Very showy border annual; large flowers. 2 ft. .... 1/4 oz. 25c. .10

**Mixed Colors** ..... 1/4 oz. 25c. .10

**MARIGOLD**. H.A. Widely grown hardy annuals, invaluable for bedding and producing an elegant display of yellow, orange and brown flowers from early Summer till frost.

**African Varieties**. Showy flowers. 3 ft.

**Guinea Gold**. Medium sized flowers, orange flushed with gold. Height, 2 ft. .... 1/4 oz. 60c. .10

**Marshall's Lemon Queen**. All-double strain .. 1/4 oz. 75c. .15

**Marshall's Prince of Orange**. All-double .... 1/4 oz. 75c. .15

**Yellow Supreme**. Creamy yellow flowers similar to Guinea Gold. 2 ft. .... 1/4 oz. 75c. .15

**Mixed**. All-double strain ..... 1/4 oz. 60c. .10

**Collection Double African**. Six colors separate..... .50

**French Varieties**. Small flowers. 12 in.

**Dwarf Gold Striped**. Rich and quaintly striped double flowers ..... 1/4 oz. 50c. .10

**Josephine**. Single, dark brown flowers with edging of old-gold. 2 ft. .... 1/4 oz. 50c. .10

**Legion of Honor**. Single yellow blooms, morked with red. .... 1/4 oz. 50c. .10

**Dwarf Mixed, Double** ..... 1/4 oz. 50c. .10

**Collection Double French Dwarf**. Six colors separate .... .50

**Giant or Tree Marigold**. Resembles the French Marigold, growing 4 to 5 ft. high. No unpleasant odor ..... .25



Marigold, African

Pkt.

**MARVEL OF PERU** (Four-o'Clocks). H.A. A well-known, handsome, free flowering garden favorite; does well everywhere. 2 ft. Mixed.....oz. 50c. \$0.10

**MATTHIOLA bicornis** (Evening Scented Stock). H.H.A. Very sweet-scented lilac flowers. 12 in. .... 1/4 oz. 35c. .10

**MATRICARIA** (Feverfew). H.H.P. Low growing plants; for beds and edgings. 12 in.

**capensis plena**. Dwarf double white ..... 1/4 oz. 50c. .10

**Golden Ball**. Very striking double golden-yellow flowers. .... 1/8 oz. \$1.00 .25

**Silver Ball**. Dainty double white, spherical flowers. .... 1/8 oz. \$1.00 .25

**MAURANDIA, Mixed Colors**. H.H.P. Tender climber. .... 1/4 oz. 50c. .15

**MIMOSA pudica** (Sensitive Plant). H.H.A. An interesting plant with rosy-lilac flowers. The leaves close when touched. 12 in..... 1/4 oz. 50c. .10

**MIMULUS**. Showy, half-hardy annuals, with handsome flowers; excellent for pots or garden. 6 in.

**tigrinus, Spotted, Mixed**..... .15

**moschatus** (Muskplant). Fragrant; for pots..... .15



Mignonette

**MECONOPSIS Baileyi.** A beautiful perennial originally found in Tibet in 1913. It bears an irregular cyme of nodding flowers of a glorious shade of sky blue; a ring of golden anthers adds to the beauty of the bloom. \$0.75

**MESEMBRYANTHEMUM crystallinum** (Ice Plant). H.H.A. A dwarf trailing annual plant; flowers white. 6 in. . . . . 1/4 oz. 50c. .10

**crinifolium.** (Livingston Daisy). An easily grown hardy annual with flowers comprising a wide range of colors. An ideal rockery or edging plant . . . . . \$0.25



Mesembryanthemum

**MIGNONETTE Large Flowering.** H.A. The popular fragrant garden annual. The seed can be sown at any time, and if successive sowings are made, its fragrant, modest colored flowers may be gathered outdoors until November. 12 in.

**Allen's Defiance.** Full, round spikes of great length. . . . . 1/4 oz. 35c. 1 oz. \$1.25 .10

**Bismarck.** Improved Dwarf. Mchet variety . . . 1/4 oz. 35c. .10

**Crimson Giant.** Deep red flowers . . . . . 1/4 oz. 35c. .10

**Goliath.** Red; enormous spikes . . . . . 1/4 oz. 50c. .10

**Golden Queen.** Compact yellow flowers . . . . . 1/4 oz. 35c. .10

**Mchet.** Strong plants of pyramidal growth; long, broad spikes of deliciously scented red flowers. 15 in. 1/4 oz. 35c. .10

**Majesty.** Selected strain for pots or benches. .1/16 oz. \$1.00 .50

**New York Market.** The finest of all the fancy varieties of Mignonette for Winter forcing . . . . . 1/16 oz. \$1.00 .50

**Sweet-scented** (Reseda odorata grandiflora). The large flowering garden variety . . . . . oz. 50c. .10

Pkt.

**MINA lobata.** H.A.C. Rapid climber, crimson and orange flowers . . . . . \$0.10

**MIRABILIS.** (See **Marvel of Peru.**)

**MOMORDICA.** H.A.C. Trailing plants, with curious foliage and fruit.

**balsamina** (Balsam-apple). Orange fruit . . . . . Oz. 75c. .10

**charantia** (Balsam-pear). Copper-colored scarlet fruit. . . . . Oz. 75c. .10

**MOONFLOWERS.** (See *Ipomoea grandiflora*.)

**MORNING-GLORIES.** (See *Ipomoea* and *Convolvulus*.)

**MUSK.** (See *Mimulus*.)

**MYOSOTIS, or FORGET-ME-NOTS.** H.H.P. Fine for edging or in beds. Seed may be sown any time from Spring until Mid-summer. 9 in.

**alpestris, Blue** . . . . . 1/4 oz. 50c. .15

**alpestris, Pink** . . . . . 1/4 oz. 50c. .15

**alpestris, White** . . . . . 1/4 oz. 50c. .15

**alpestris, Mixed Colors.** White, blue, pink, etc. . . 1/4 oz. 50c. .10

**dissitiflora.** Blooms very early; flowers blue . . . 1/8 oz. \$1.00 .15

**palustris semperflorens.** The true water Forget-me-not. Blooms from early Spring until Autumn. Dark blue. . . . . 1/4 oz. \$1.00 .15

**Marshall's Blue Bird.** A very fine dark blue variety with long stems for Winter blooming . . . . . .50

**Marshall's Royal Blue.** Early and free flowering; color deep indigo blue. Fine for borders or cutting . . . . 1/4 oz. \$1.00 .15

**Ruth Fischer.** Compact growth; blue flowers . . . . . .25

**Victoria.** The plants are of dwarf, compact growth, with a multitude of bright blue flowers in dense umbels. . . . . 1/4 oz. \$1.00 .15

**NASTURTIUM** (*Tropaeolum nanum*). H.A. **Tom Thumb, or Dwarf Varieties.** These have a compact habit and attractive foliage; bloom in two months from sowing, and most profusely the whole season. 12 in.

**Aurora.** Yellow-veined . . . . . Oz. 20c. .10

**Beauty.** Yellow and scarlet . . . . . Oz. 20c. .10

**Cloth of Gold.** Scarlet, yellow foliage . . . . . Oz. 20c. .10

**Empress of India.** Crimson, dark foliage . . . . . Oz. 20c. .10

**King Theodore.** Garnet, dark foliage . . . . . Oz. 20c. .10

**King of Tom Thumbs.** Scarlet . . . . . Oz. 20c. .10

**luteum.** Bright yellow; no blotches . . . . . Oz. 20c. .10

**Pearl.** Creamy white . . . . . Oz. 20c. .10

**Rose Color** . . . . . Oz. 20c. .10

**Marshall's Dwarf Rainbow Mixture.** These contain all the leading named sorts, mixed. Oz. 20c., 1/4 lb. 50c., lb. \$1.50 .10

**Collection of 12 Varieties** . . . . . .60

**Golden Gleam. Double Sweet Scented flowers.** Golden yellow flowers, semi-dwarf habit . . . . . Oz. 35c. .10

**Scarlet Gleam.** Double. Fiery orange scarlet . . . . . Oz. 75c. .25

**Double Gleam Hybrids.** Various colors . . . . . Oz. 50c. .15

**NASTURTIUM** (*Tropaeolum majus*). H.A.C. **Tall, or Climbing Varieties.** Adapted for rockwork, banks, covering trellises or rustic work; the seeds, if picked young, are an excellent substitute for capers. 6 ft.

**Chameleon.** Various colors on one plant . . . . . Oz. 20c. .10

**Dark Crimson** . . . . . Oz. 20c. .10

**King Theodore.** Crimson; dark foliage . . . . . Oz. 20c. .10

**Pearl.** Creamy white . . . . . Oz. 20c. .10

**Rose Von Moltke** . . . . . Oz. 20c. .10

**Scarlet** . . . . . Oz. 20c. .10

**Yellow** . . . . . Oz. 20c. .10

**Vesuvius.** Salmon-rose . . . . . Oz. 20c. .10

**Marshall's Tall Rainbow Mixture.** From the best varieties. . . . . Oz. 20c., 1/4 lb. 50c., lb. \$1.50 .10

**Collection of Twelve Varieties** . . . . . .60

**Lobb's Nasturtiums** (*Tropaeolum Lobbianum*). H.A.C. Very free blooming. The most brilliant colors, climbing about 6 ft. Excellent for window boxes, vases and hanging baskets.

**Lobb's Finest Mixture** . . . . . Oz. 25c. .10

**Madame Gunther Hybrids.** A French strain; noted for wide range of fine colors . . . . . Oz. 25c. .10

**NEMESIA.** H.A. Splendid for bedding or forcing in greenhouse. Pkt.

**strumosa grandiflora Suttoni. Orange.** Bushy plants; flowers of unique form. 12 in. .... 1/16 oz. \$1.00 \$0.25

**strumosa grandiflora Suttoni. White** ..... 1/16 oz. \$1.00 .25

**strumosa grandiflora Suttoni. Mixed colors**... 1/16 oz. \$1.00 .25

**compacta Blue Gem.** Large flowers of a pretty Forget-me-not blue; a fine pot plant ..... 1/16 oz. \$1.00 .25

**compacta Triumph.** New dwarf, compact. 6 in. Finest mixture ..... 1/16 oz. \$1.00 .25

**NEMOPHILA.** H.A. Splendid, free flowering annual, with cup-shaped flowers of many bright colors. 12 in.

**Mixed Colors** ..... 1/4 oz. 35c. 10



Nepeta Mussini

**NEPETA MUSSINI.** H.P. A favorite for edging. Blue-grey foliage surmounted by pale mauve flowers. 9 in. .... .25

**NICOTIANA affinis.** H.A. Fragrant, star-shaped white flowers. 3 ft. .... 1/4 oz. 35c. 10

**affinis Hybrids.** Large scented flowers, mixed shades. .... 1/4 oz. 50c. 10

**Crimson Bedder.** A dwarf strain about 15 inches high; admirably suited for bedding purposes. The flowers are of a rich deep crimson, and make a striking effect. .... 1/8 oz. 75c. .25

**Dwarf White.** Adapted for pot work or borders, the sweet-scented flowers remain open all day. 18 in. .... .25

**Sanderae, Crimson King.** Dark crimson-red .... 1/4 oz. 75c. .25

**Sanderae Hybrids.** All colors. 4 ft. .... 1/4 oz. 35c. 10

**NIEREMBERGIA frutescens.** H.H.P. For hanging baskets or borders; large, cup-shaped lilac flowers .... 1/4 oz. 50c. 10

**NIGELLA (Love-in-a-Mist).** H.A. Beautiful border plants. 18 in.

**Miss Jekyll.** A lovely variety with cornflower-blue blossoms; splendid for cutting ..... 1/4 oz. 35c. 10

**Miss Jekyll, White.** Valuable for borders and cutting. .... 1/4 oz. 35c. 10

**Damascena. Finest Mixed.** Blue, white and purple. 1/4 oz. 30c. 10

**OENOTHERA (Evening Primrose).** H.A. Useful for exposed sunny position, blooming the entire Summer.

**Afterglow.** Yellow with brilliant red calyx flowers. 3 ft. .... .15

**Missouriensis.** A dwarf, hardy perennial variety with large yellow flowers. Very useful for rockwork ..... .25

**Finest Mixed.** Annual varieties. 1 ft. .... 1/4 oz. 35c. .15

**MARSHALL'S SUPER GIANT PANSIES**

This strain of truly Giant Pansies is of most vigorous growth, the enormous flowers are carried on exceptionally long stems and have a fine range of brilliant colors. Excellent for show work or as a pot plant.

Price, \$2.00 per packet.



Nigella, Miss Jekyll

**PANSY.** H.H.P. The most popular flower grown. They thrive best in a cool, moist, but well-drained soil. Sown the seeds in April and May for Summer flowering and August for early flowers the following Spring. Our mixtures contain a large variety of colors. Pkt.

**Marshall's Special Mixture.** Saved from only the largest and best shaped flowers of the richest colors. Fine for greenhouse flowering ..... 1/16 oz. \$3.00 \$1.00

**Marshall's Greenhouse Mixture.** A selection of varieties adapted for growing under glass ..... 1/16 oz. \$1.25 .50

**Marshall's Matchless Mixture.** This matchless strain consists entirely of the newest, best shaped and most handsome flowers, including an immense variety of brilliant colors. The seeds we offer are carefully saved from the largest, selected flowers ..... 1/8 oz. \$2.00 .50

**Marshall's Superb Blotched Mixed.** Immense flowers, five blotched, full round form comprising the most magnificent colors ..... 1/8 oz. \$1.50 .25

**Masterpiece.** A beautiful strain of blotched and curled varieties ..... 1/8 oz. 75c. .25

**Giant Trimardeou, Mixed.** Large flowers in a good variety of colors ..... 1/4 oz. \$1.00 .10

**GIANT PANSIES, In Varieties.**

**Giant Adonis.** A beautiful light blue ..... 1/8 oz. 75c. .15

**Giant Apricot Bedder.** A rich deep apricot. Excellent for bedding ..... 1/8 oz. 75c. .15

**Giant Cardinal.** A very brilliant red ..... 1/8 oz. 75c. .15

**Giant Emperor.** Ultramarine blue ..... 1/8 oz. 75c. .15

**Giant Fire King.** Crimson-purple and golden yellow. .... 1/8 oz. 75c. .15

**Giant Golden Queen.** Beautiful pure yellow ..... 1/8 oz. 75c. .15

**Giant Golden Yellow, with dark eye** ..... 1/8 oz. 75c. .15

**Giant King of the Blacks** ..... 1/8 oz. 75c. .15

**Giant Lord Beaconsfield.** Violet, shaded white ... 1/8 oz. 75c. .15

**Giant Orange King.** Vivid orange ..... 1/8 oz. \$1.00 .15

**Giant Prince Bismarck.** Light brown shade with black eye. .... 1/8 oz. 75c. .15

**Giant Snow Queen.** Pure white ..... 1/8 oz. 75c. .15

**Giant Striped.** Variety of markings ..... 1/8 oz. 75c. .15

**Giant Victoria.** Wine-red shades ..... 1/8 oz. 75c. .15

**Giant White, with black eye** ..... 1/8 oz. 75c. .15

**Collection of Six Varieties, Giant Named** ..... .75

**Collection of Twelve Varieties, Giant Named** ..... 1.50

**PAPAVER.** (See Poppies.)

**PASSIFLORA caerulea (Passionflower).** H.H.C. Fast growing and free flowering, ornamental perennial climbers, with large, showy blue flowers, suitable for conservatory or outside in Summer. .... 1/4 oz. 75c. .15

**PENTSTEMON.** H.P. Highly useful and attractive hardy perennials and much used in the hardy border. 2 ft.

**gloxinoides "Sensation."** A grand variety of colors. Will bloom from seed in June if sown early in March. .... 1/8 oz. \$1.50. .25

**Marshall's Matchless Gentanoides Hybrids.** A superb mixture ..... 1/8 oz. \$1.50. .25

**PERILLA Nankinensis.** H.A. Ornamental-leaved plants. 18 in. .... 1/4 oz. 25c .10



Platycodon

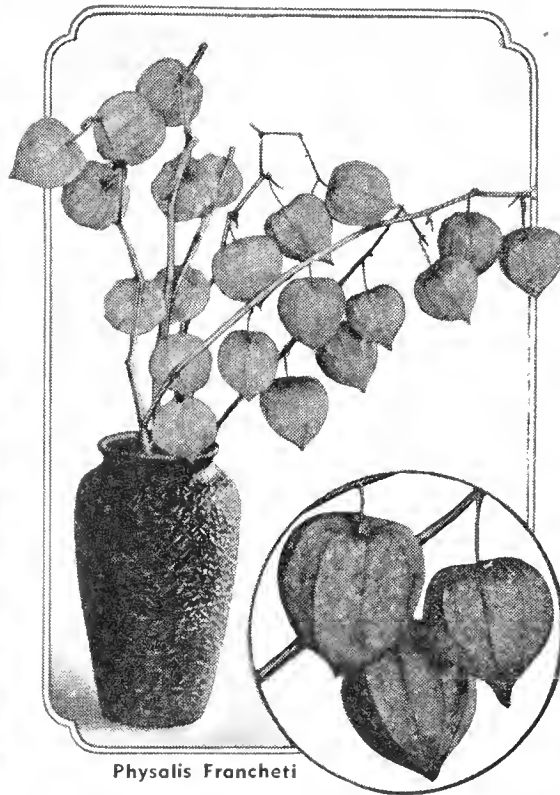

Physalis Francheti



Polemonium

**PETUNIA.** H.A. One of our easiest cultivated and freest flowering annuals. Will succeed almost anywhere and give a continuity of the most brilliant bloom from June till killed by frost. 18 in. Pkt.

**Giant Flowered Giant Double.** This strain is carefully pollinized and will produce a good percentage of beautiful double flowers.

**Giant Fringed Double Pink** .....\$0.50  
**Giant Fringed Double Violet** ..... .50  
**Giant Fringed Double White** ..... .50  
**Giant Fringed Double Finest Mixed** ..... .50

**Single Varieties:**

**Giant Flowering Fringed Single.** A new giant type with immense ruffled flowers suitable for bedding. Seeds of this type obtained by artificial pollinization to insure the best possible strain.

**Giant Fringed Single Blue** ..... .35  
**Giant Fringed Single Rose** ..... .35  
**Giant Fringed Single White** ..... .35  
**Giant Fringed Single Finest Mixed** ..... .25

**Theodosia.** Deep rose-pink, heavily frilled. Good for either pots or bedding ..... 50

**Marshall's Superb Large-flowered Mixed (California Giants).** Magnificent flowers with throats beautifully veined ..... 25

**Large-flowered, Finest Mixed.** Fine large flowers in superb mixture ..... 1/16 oz. \$1.00 .15

**Fine Mixed.** An assortment of medium-sized flowers; fine for bedding ..... 1/4 oz. 50c. .10

**Dwarf California Giants.** A dwarf sturdy growing type suitable for pots or bedding. Flowers beautifully ruffled and fringed. A mixture of most desirable colors ..... 50

**Marshall's Violet Queen.** A grand Petunia for bedding growing about 18 in. high and very free flowering. A velvety dark violet without a trace of magenta ..... 75

**Balcony Blue.** Adapted for vases and window boxes. .... 1/8 oz. \$1.50 .25  
**Balcony Rose** ..... 1/8 oz. \$1.50 .25  
**Balcony White** ..... 1/8 oz. \$1.50 .25  
**Balcony Finest Mixed** ..... 1/8 oz. \$1.00 .25  
**Rose Gem, nana compacta.** A neat compact plant five to six inches high ..... 1/8 oz. \$2.50 .25  
**Martha Washington, nana compacta.** The plants are about 9 inches high in a perfect ball effect. Flowers blush-pink at edges, violet throat, heavily veined ..... 50  
**Heavenly Blue or Silver Blue.** A pleasing shade of light silvery-blue. 24 inches ..... 1/8 oz. \$1.50 .25  
**General Dodds.** Fine dark red ..... 1/4 oz. \$1.00 .15  
**Marshall's Purple Bedder.** A beautiful purple bedding variety ..... 1/8 oz. \$1.00 .25  
**Rosy Morn.** Soft carmine-pink ..... 1/8 oz. \$1.00 .15  
**Rose of Heaven.** Rose-pink ..... 1/8 oz. \$1.00 .15  
**Snowball.** Dwarf pure white; a fine bedding variety. .... 1/8 oz. 75c. .15

**PHACELIA campanularia.** H.A. Showy, with bright blue, bell-shaped flowers. 9 in. .... 1/4 oz. 75c. \$0.15

**PHLOX Drummondii grandiflora.** H.A. Improved, large-flowering strain of this famous garden annual. Prefers a light, rich loam in sun or semi-shade. Seed may be sown in the open ground any time after danger from frost is past. 12 in.

**Violet** ..... 1/4 oz. 75c. .10  
**Brilliant Rose** ..... 1/4 oz. 75c. .10  
**Chamois Rose** ..... 1/4 oz. 75c. .10  
**Crimson** ..... 1/4 oz. 75c. .10  
**Isabellina.** Yellow or primrose ..... 1/4 oz. 75c. .10  
**Vivid Scarlet** ..... 1/4 oz. 75c. .10  
**White** ..... 1/4 oz. 75c. .10  
**stellata splendens.** Starlike crimson ..... 1/4 oz. 75c. .10  
**Choicest Mixed.** Contains a very large variety of color. .... 1/4 oz. 50c. .10

**PHLOX, Large-flowering, Dwarf Varieties.**

**nana compacta, Fireball.** Bright red ..... 1/8 oz. 75c. .15  
**nana compacta, Snowball.** Compact, pure white. .... 1/8 oz. 75c. .15  
**nana compacta, Yellow** ..... 1/8 oz. \$1.00 .15  
**nana compacta, Mixed Colors** ..... 1/8 oz. 75c. .10

**PHLOX, Hardy Perennial, decussata.** Most brilliant colored flowers in late Summer and Fall. 3 ft. .... 1/4 oz. \$1.75 .25

**PHYSALIS Francheti (Chinese Lantern).** H.P. Balloon-like fruits. 3 ft. .... 1/4 oz. \$1.00. .15

**PHYSOSTEGIA (False-dragonhead).** H.P. 3 ft.

**virginica.** One of the prettiest hardy perennials. It forms dense bushes bearing freely spikes of delicate pink tubular flowers ..... 1/8 oz. 50c. .15  
**virginica alba.** Pure white ..... 1/8 oz. 50c. .15

**PINKS.** (See **Dianthus**.)

**PLATYCODON.** H.P. The large-flowering Chinese Bell-flowers. 2 ft.

**grandiflorum.** Large, steel-blue flowers ..... 1/8 oz. 50c. .15  
**album.** Pure white variety ..... 1/8 oz. 50c. .15  
**mariesi.** Dwarf, large flowered blue. 12 in. .... 1/8 oz. 75c. .15

**POLEMONIUM coeruleum grandiflorum (Jacobs-ladder).** H.P. Deeply cut foliage and clusters of handsome blue flowers. 2 ft. .... 1/4 oz. 75c. .10  
**grandiflorum album.** Pure white ..... 1/4 oz. 75c. .10

**POLYANTHUS (Primula elatior).** H.H.P. Desirable for greenhouse flowering or bedding out in the Spring. 9 in.

**Marshall's Matchless Gold Laced.** Saved from the largest flowers in a wide range of colors ..... 1/8 oz. \$2.00 .50  
**Munstead Giants.** A magnificent strain of Bunch Primroses in shades of yellow and white ..... 1/8 oz. \$2.00 .50

**POPPIES.** Showy, free blooming, old-fashioned flowers. Very effective in mixed borders.

**SINGLE ANNUAL VARIETIES:**

	Pkt.
<b>glaucum</b> (The Scarlet Tulip Poppy) . . . . .	1/4 oz. 25c. \$0.10
<b>King Edward.</b> Free flowering, beautiful scarlet . . . . .	1/4 oz. 35c. .10
<b>Miss Sherwood.</b> Flowers satiny white and chamais-rose . . . . .	1/4 oz. 30c. .10
<b>The Bride.</b> A beautiful variety with large, pure white flowers . . . . .	1/4 oz. 30c. .10
<b>Virginia.</b> Flowers white, edged soft pink, fringed . . . . .	1/4 oz. 30c. .10
<b>Marshall's Extra Selected Shirley.</b> A grand variety of colors, saved from selected flowers. Their brilliant, dazzling coloring and wonderful variety make a very effective display in the garden or for cut flowers . . . . .	1/4 oz. 35c. .10
<b>American Legion Shirley.</b> Brilliant orange-scarlet, yellow anthers. Should be grown extensively for Poppy Day . . . . .	1/4 oz. 50c. .10
<b>Blue Shirley.</b> A splendid assortment of colors . . . . .	1/4 oz. 50c. .10
<b>Pure White Shirley</b> . . . . .	1/4 oz. 50c. .10
<b>Rose-Pink Shirley.</b> A beautiful pink variety . . . . .	1/4 oz. 50c. .10

**DOUBLE ANNUAL VARIETIES:**

	Pkt.
<b>American Flag.</b> White, edged red . . . . .	1/4 oz. 25c. \$0.10
<b>Carnation-Flowered.</b> Mixed colors . . . . .	1/4 oz. 25c. .10
<b>Eldorado Double Mixed.</b> A double form of Shirley Poppy, in choice mixture . . . . .	1/4 oz. 25c. .10

	Pkt.
<b>Mikado.</b> White, edged scarlet . . . . .	1/4 oz. 25c. \$0.10
<b>Paeony-Flowered.</b> Mixed colors . . . . .	1/4 oz. 25c. .10
<b>White Swan.</b> Large, beautifully fringed white flowers . . . . .	1/4 oz. 25c. .10

**HARDY PERENNIAL VARIETIES:**

<b>bracteatum.</b> Orange-scarlet, hardy Poppy. . . . .	1/4 oz. 50c. .10
---	------------------

**ICELAND POPPIES:**

While these are hardy perennials, they flower the first year from seed, blooming almost as quickly as the annual sorts.

<b>nudicaule</b> (Iceland Poppy). Dwarf, bright yellow . . . . .	1/4 oz. 50c. .15
--	------------------



Shirley Poppy

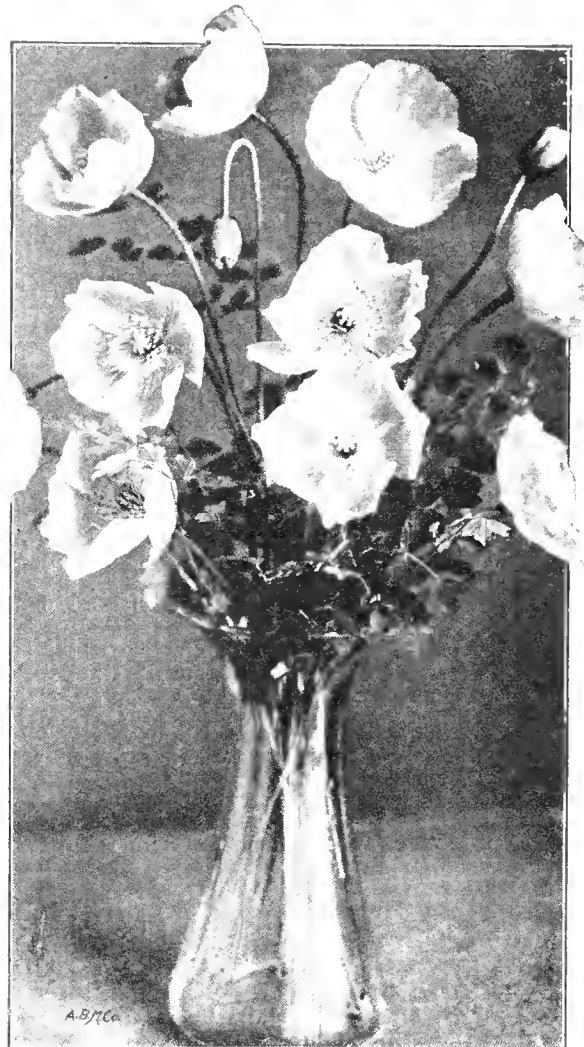

Iceland Poppies



Double Annual Poppies

**ICELAND POPPIES—Continued.**

	Pkt.
— <b>Aurantiacum.</b> Orange-scarlet . . . . .	1/4 oz. 50c. \$0.15
— <b>album.</b> Pure white . . . . .	1/4 oz. 50c. .15
— <b>Coonara Pinks.</b> Long stemmed flowers in superb shades of rose and pink . . . . .	1/4 oz. 50c. .15
— <b>Mixed Iceland Poppies</b> . . . . .	1/4 oz. 50c. .15
<b>ORIENTAL POPPIES, Mixed Hybrids.</b> 3 ft. The colors vary from bluish white, orange and deep ruby, including a large percentage of art shades . . . . .	1/4 oz. 75c. .10

**PORTULACA.** H.A. One of the freest flowering dwarf annuals, especially adapted for sunny locations. Flowers of the most brilliant colors. 6 in.

<b>Single Rose</b> . . . . .	1/4 oz. 50c. .10
<b>Single Scarlet</b> . . . . .	1/4 oz. 50c. .10
<b>Single White</b> . . . . .	1/4 oz. 50c. .10
<b>Single Yellow</b> . . . . .	1/4 oz. 50c. .10
<b>Single Mixed.</b> All colors . . . . .	1/4 oz. 35c. .10
<b>Double Large Flowering.</b> Pkt. Will produce a large percentage of double flowers in many colors.	
<b>Finest Mixed</b> . . . . .	1/4 oz. \$1.25 \$0.15

**POTENTILLA.** H.P.

Splendid hardy perennials with ornamental foliage and brilliant flowers in shades of yellow and red from June to August. 2 ft.

<b>Single Mixed.</b> Various shades of yellow and brown . . . . .	.15
<b>Double Hybrids, Mixed.</b> Saved from a choice strain, will produce many doubles . . . . .	.25

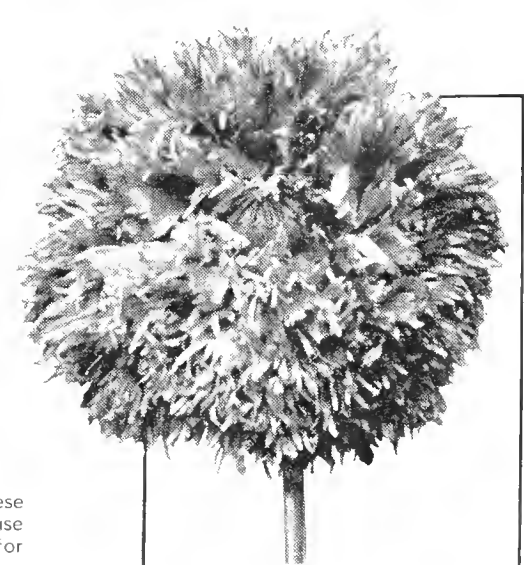

Double Carnation-Flowered Poppy

**PRIMULA sinensis fimbriata** (Chinese Primrose). G.P. A charming profuse flowering plant indispensable for winter and spring decoration.

<b>Matchless Mixed</b> . . . . .	.50
----------------------------------	-----

	Pkt.
<b>PRIMULA obconica.</b> One of the most useful greenhouse plants.	
<b>obconica gigantea alba.</b> White.....	\$0.50
— <b>lilacina.</b> Lilac .....	.50
— <b>Kermesina.</b> Strong grower. Flowers of a rich ruby-crimson color .....	.50
— <b>rosea.</b> Rose .....	.50
— <b>Finest Mixed</b> .....	.50
— <b>Eureka.</b> A new giant form of obconica. Rich rosy carmine, shaded cerise, a clear yellow eye .....	
	1.00
<b>malacoides.</b> A charming free flowering plant; delicate lilac..	.50
— <b>alba.</b> Pure white .....	.50
— <b>Pink Beauty.</b> Large flowers of a beautiful rosy pink, shading to mauve .....	
	.50
— <b>rosea.</b> Charming rose-pink .....	.50
— <b>superba.</b> Larger flowers and much deeper in color than malacoides .....	.50
<b>Kewensis.</b> Bright yellow, fragrant flowers .....	.50
<b>stellata</b> (The Star Primula). Excellent pot plants for decorative purposes. Mixed colors .....	.50
<b>HARDY PRIMULAS or Primroses.</b>	
<b>Beesiana.</b> Very free flowering. Glowing velvety purple with yellow eye .....	.25
<b>Cashmeriana.</b> Dense heads of lilac flowers. Good. 1 ft. ...	.50
<b>Japonica</b> (Japanese Primrose). Mixed colors .....	.25
<b>Marshall's Blue Primrose.</b> H.P. Many shades of blue to deep violet .....	.50
<b>Veris.</b> (See Cowslip.)	
<b>vulgaris.</b> English Yellow Primrose .....	1/8 oz. \$1.00 .15
<b>vulgaris Hybrids.</b> Very choice hybrids of the English Yellow Primrose .....	.35
<b>PYRETHRUM.</b> H.H.P. Fine for edging and borders. 6 in.	
<b>aureum, Golden Feather.</b> Bright yellow foliage. 1/4 oz. 50c. .10	
<b>hybridum.</b> H.P. Large Daisy or Cosmos-like flowers; blooms in early Summer and late Fall. 18 in.	
<b>Single.</b> Large-flowering, mixed colors .....	1/4 oz. \$1.00 .15
<b>hybridum fl. pl., Double.</b> Large-flowering, beautiful colors. ....	1/8 oz. \$2.00 .25



Primula Cashmeriana

	Pkt.
<b>REHMANNIA angulata.</b> H.H.P. Flowers rose-purple with spotted throat. A good decorative greenhouse plant of easy cultivation. 3 ft. ....	\$0.25
<b>RHODANTHE</b> (Swan-river Everlasting). H.A. Handsome pink and white, annual everlasting, excellent for bouquets of dried flowers. 1 ft.	
<b>maculata.</b> Rose with dark center .....	1/4 oz. 35c. .10
— <b>alba.</b> Pure white .....	1/4 oz. 35c. .10
<b>Finest Mixed</b> .....	1/4 oz. 35c. .10
<b>RICINUS</b> (Castor Oil Plant). H.A. From seed they quickly attain gigantic proportions and are ornamental till destroyed by frost. 6 ft.	
<b>cambodgensis.</b> Maroon foliage .....	Oz. 35c. .10
<b>gibsoni.</b> Purplish leaves and stems .....	Oz. 35c. .10
<b>panormitans.</b> Large dark brown leaves, blue powdered stems, upright habit .....	Oz. 35c. .10
<b>sanguineus.</b> Red stems .....	Oz. 35c. .10
<b>zanzibariensis, Mixed.</b> Immense leaves. 8 ft. ....	Oz. 35c. .10
<b>Mixed Varieties</b> .....	Oz. 25c. .10
<b>ROCKET, SWEET</b> (Hesperis). H.P. A very interesting, useful, free-flowering plant. 18 in.	
<b>Purple.</b> Beautiful purple color .....	1/4 oz. 35c. .10
<b>White.</b> Flowers rosy white .....	1/4 oz. 35c. .10
<b>Finest Mixed Colors</b> .....	1/4 oz. 35c. .10
<b>ROMNEYA Coulteri</b> (The California Tree Poppy). H.H.P. Large, snowy white flowers. Requires protection in Winter. 2 ft. ....	
	.25
<b>RUDBECKIA bicolor superba.</b> H.A. Yellow flowers. 2 ft. ....	
	1/4 oz. 50c. .15
<b>Newmanni.</b> H.P. Bright orange with black cone. 2 ft. ....	1/4 oz. \$1.00 .15
<b>purpurea hybrida grandiflora.</b> H.P. Beautiful large-flowered hybrids. 2 ft. ....	.15
<b>SALPIGLOSSIS.</b> H.A. One of the prettiest annuals, of easy culture; very showy in beds or borders. Orchid-like flowers from early Summer until late Fall. 2 ft.	
<b>Marshall's Matchless Varieties:</b>	
<b>Chamois</b> .....	1/8 oz. 50c. .15
<b>Golden Yellow</b> .....	1/8 oz. 50c. .15
<b>Scarlet</b> .....	1/8 oz. 50c. .15
<b>Rose and Gold</b> .....	1/8 oz. 50c. .15
<b>Scarlet and Gold</b> .....	1/8 oz. 50c. .15
<b>Violet</b> .....	1/8 oz. 50c. .15
<b>Violet and Gold</b> .....	1/8 oz. 50c. .15
<b>Yellow and White</b> .....	1/8 oz. 50c. .15
<b>Matchless Mixture.</b> All colors .....	1/4 oz. 75c. .15
<b>Large Flowering.</b> Mixed colors .....	1/4 oz. 50c. .10
<b>Collection of 6 Separate Colors</b> .....	.75
<b>SALVIA</b> (Flowering Sage). One of our most handsome Summer and Autumn-flowering plants, growing into compact bushes 2 to 3 ft. high and literally ablaze with brilliant flowers.	
<b>azurea grandiflora.</b> H.H.P. Pretty sky-blue flowers in August and September. 4 ft. ....	1/8 oz. \$1.00 .25
<b>America, or Globe of Fire.</b> H.H.P. The earliest, freest and most continuous bloamer .....	1/8 oz. \$1.50 .25
<b>Blue Beard</b> (Clary). H.A. Elegant plant with showy spikes of bright purple flowers .....	1/4 oz. 50c. .10
<b>Bonfire.</b> H.H.P. A splendid dwarf variety, with large, erect spikes of rich scarlet flowers .....	1/8 oz. 75c. .15
<b>farinacea, Blue Bedder.</b> H.H.P. Long spikes of deep blue flowers. Excellent for cutting .....	1/8 oz. \$1.00 .25
<b>Harbinger, Early Flowering.</b> H.H.P. A dwarf variety which will come into flower in early Summer. Spikes of dazzling bright scarlet flowers. 1 ft. ....	.25
<b>Oxford Blue</b> (Horminum). This unique colored Salvia, as the name suggests, is a deep Oxford Blue and of a purity of tone found in no other annual .....	
	.35
<b>Salmon Beauty.</b> H.H.P. A superior strain with salmon colored blooms. 1 1/2 ft. high .....	.25
<b>splendens grandiflora.</b> H.H.P. (Scarlet Sage). A rich flowered bedder .....	1/4 oz. 75c. .10
<b>patens.</b> H.H.P. Magnificent blue flowers .....	1/8 oz. \$1.50 .25
<b>SANVITALIA procumbens fl. pl.</b> H.A. Pretty bright double yellow flowers. 6 in. ....	
	1/4 oz. 75c. .10





Scabiosa, Large Flowered

**SAPONARIA calabrica.** Dwarf annual with pink starry flowers. 6 in. . . . . ¼ oz. 35c. \$0.10 Pkt.  
**vaccaria.** Graceful sprays of pale rose flowers. Also used as a greenhouse pot plant. 2 ft. . . . . ¼ oz. 35c. .10

**SCABIOSA, or MOURNING BRIDE.** H.A. One of our best Summer flowering annuals. The rich and beautiful colored flowers are very handsome and excellent for cutting; profuse bloomer. June to October. 2½ ft.

**LARGE-FLOWERING TALL DOUBLE VARIETIES:**  
**Cherry Red** . . . . . ¼ oz. 40c. .10  
**Fiery Scarlet** . . . . . ¼ oz. 40c. .10  
**King of the Blacks.** Deep purple-black . . . . . ¼ oz. 40c. .10  
**Lavender Blue** . . . . . ¼ oz. 40c. .10  
**Loveliness.** Soft delicate salmon-rose. Large fragrant flowers . . . . . ¼ oz. 75c. .15  
**Peach Blossom.** A beautiful shade of pink, of large size and long stems. An excellent cut flower . . . ¼ oz. 40c. .10  
**Rose Pink** . . . . . ¼ oz. 40c. .10  
**Pure White** . . . . . ¼ oz. 40c. .10  
**Finest Mixed.** All colors . . . . . ¼ oz. 35c. .10  
**Dwarf Double.** Mixed . . . . . ¼ oz. 35c. .10

**PERENNIAL VARIETIES:**  
**caucasica.** Lavender-blue . . . . . ⅛ oz. \$1.00 .25  
**caucasica alba.** Delicate white flowers. 2 ft. . . ⅛ oz. \$1.25 .25  
**caucasica Hybrids.** (Isaac House Strain.) A wonderful cut flower with large, long-stemmed flowers, outer edges ruffled. Colors light lavender to dark blue . . . . . 35  
**columbaria, Lavender.** Large flowers . . . . . .25  
**columbaria, Pink.** A beautiful shade . . . . . .25  
**japonica.** Lavender-blue flowers on long stems, flowering continuously all Summer. 2½ ft. . . . . ¼ oz. 75c. .15

**SCHIZANTHUS** (Butterflyflower). H.H.A. Beautiful and showy, erect growing, hardy annuals for house or garden; very free-flowering, continuing through the Summer and Autumn. 1½ ft.

**Dr. Badger's Hybrids.** Large flowered, excellent and very varied. Greenhouse grown . . . . . .50

**Monarch Strain. Re-selected.** This is a superlative mixture and a great advance on anything hitherto available. The large pansy-like flowers in all shades make a riot of color, almost unbelievable. This strain is distinct from all other mixtures . . . . . .75

**SCHIZANTHUS—** Pkt.  
**Grahami.** Free flowering red variety . . . . . \$0.25  
**hybridus grandiflorus, Pink** . . . . . .25  
**hybridus grandiflorus, Rose** . . . . . .25  
**hybridus grandiflorus, Finest Mixed.** Very choice. ¼ oz. 50c. .10  
**wisetonensis, Marshall's Select Hybrids.** Flowers varying from white with yellow eye to rose with bronze center. Fine for pots . . . . . .25  
**wisetonensis compacta, Mixed.** Beautiful and varied colors. 10 in. . . . . .25  
**Bridal Veil.** White . . . . . .25

**SEDUM** (Stonecrop). Popular dwarf hardy Perennials for rock gardens.  
**acre.** Yellow 4 in. . . . . .35  
**anglicum.** White tinged pink. 4 in. . . . . .35  
**coeruleum.** Small blue. 9 in. . . . . .35  
**Ewersi.** Rose 9 in. . . . . .50  
**Middendorffi.** Yellow, dark leaves. 6 in. . . . . .50

**SENECIO elegans fl. pl.** (Jacobaea), H.A. Free flowering pretty annual. Mixed colors. 18 in. . . . . .15

**SENSITIVE PLANT.** (See *Mimosa pudica*.)

**SHAMROCK.** G.P. True small-leaved variety . . . ¼ oz. 50c. .15

**SIDALCEA, Stark's Hybrids.** H.P. A hardy border plant. All shades from blush-pink, rose, carmine and crimson. 2 to 4 ft. . . . . .50  
**Rosy Gem.** 3 ft. . . . . .25

**SILENE** (Catchfly). Very pretty and profuse blooming plants.  
**compacta.** H.A. Double. Mixed colors. 2 ft. . . . ¼ oz. 50c. .10  
**orientalis.** H.P. Large, globular heads of bright rose flowers, which are clove-scented. Useful for cutting. 2 ft. . . . . ¼ oz. 50c. .10  
**Schafta.** H.P. A good rock plant, trailing habit, pink flowers. 4 to 6 in. . . . . .15

**SMILAX** (*Myrsiphyllum asparagoides*). G.P. Popular greenhouse climber with small dark green foliage . . ¼ oz. 35c. .10

**SNAPDRAGON.** (See *Antirrhinum*.)

**SOLANUM capsicastrum nanum** (Jerusalem Cherry). G.P. Ornamental plant for Winter decoration, with bright scarlet berries . . . . . ¼ oz. 50c. .10  
**Cleveland.** Valuable as a pot plant. Brilliant red fruit . . . . .25

**STATICE.** H.A. Beautiful free-flowering plants adapted for beds or borders. The flowers, when dried, make pretty decorations for Winter use. 1½ to 2 ft.

**ANNUAL VARIETIES:**  
**Bonduelli.** Bright yellow flowers. . . . . ½ oz. 50c. .10  
**sinensis.** Very graceful plant; flowers pure white with canary-yellow . . . . . ⅛ oz. 50c. .10  
**sinuata, Blue.** Light shade of blue . . . . . ½ oz. 75c. .15  
**—candidissima.** Pure white . . . . . ½ oz. 75c. .15  
**—rosea superba.** Fine bright rose . . . . . ½ oz. 75c. .15  
**—True Blue.** Fine deep blue . . . . . ½ oz. 75c. .15  
**—hybrida Mixed.** Flowers mauve, purple, white and yellow. . . . . ½ oz. 50c. .10  
**Suworowi.** Flowers bright rosy color; fine for Winter decorations . . . . . ⅛ oz. 50c. .15

**PERENNIAL VARIETIES:**  
**incana hybrida nana, Mixed.** H.P. A charming variety of Sea-lovender. Fine for bouquets . . . . . ¼ oz. 75c. .10  
**latifolia.** H.P. Lavender-blue flowers . . . . . ¼ oz. 75c. .10  
**Perezii.** H.H.P. A beautiful bright blue. Adapted for borders and greenhouse forcing. 1½ ft. . . . . ¼ oz. \$1.00 .25

**STEVIA serrata.** G.P. A greenhouse plant with fragrant, tiny white flowers; exceedingly valuable for cutting. 2 ft. . . . . ¼ oz. 75c .10

**STOKESIA cyanea.** H.P. Lovender-blue flowers. 2 ft. . . . . ¼ oz. \$1.00 .15  
**Finest Mixed.** A mixture of pink, purple, blue and white shades . . . . . ¼ oz. \$1.00 .15

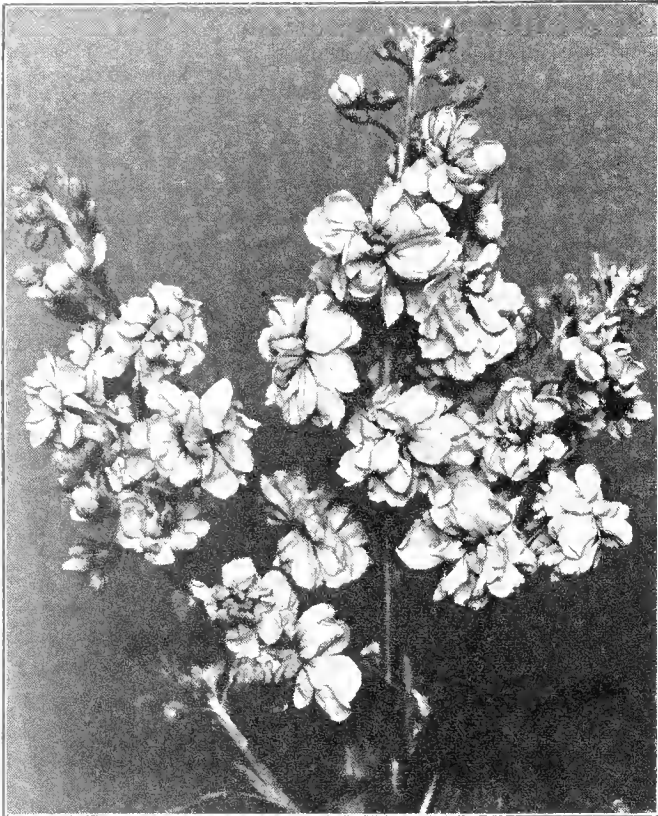

Ten Weeks Stocks

**STOCKS** (Gilliflower). H.A. One of the most highly prized of all our cultivated flowers. The delightful fragrance, free-blooming character and beautiful colors have made them as desirable for Winter cultivation in the greenhouse as for the garden in Summer; invaluable as cut flowers.

**MARSHALL'S GIANT FLOWERING TEN WEEK.** A dwarf compact early flowering variety of branching habit especially adopted for bedding. Height, 1 foot.

Aurora, cream tinted pink	1/8 oz.	\$1.00	\$0.25
Canary Yellow	1/8 oz.	1.00	.25
Carmine	1/8 oz.	1.00	.25
Crimson	1/8 oz.	1.00	.25
Dark Blue	1/8 oz.	1.00	.25
Flesh	1/8 oz.	1.00	.25
Light Blue	1/8 oz.	1.00	.25
Rose	1/8 oz.	1.00	.25
White	1/8 oz.	1.00	.25
Choicest Mixed, from named varieties	1/8 oz.	.75	.15
Collection of Six Colors			1.25
Collection of Nine Colors			2.00

**WINTER FLOWERING. (Double Beauty of Nice Type).** 2 ft.

Abundance. Carmine-rose	1/8 oz.	\$1.25	.25
Almond Blossom. White shaded pink	1/8 oz.	1.25	.25
Beauty of Nice. Flesh-pink	1/8 oz.	1.25	.25
Blanche Fournier. Ashes of roses color, also suitable for outside	1/8 oz.	1.25	.50
Lloyd George. Blood-red	1/8 oz.	1.25	.25
Mont Blanc. White	1/8 oz.	1.25	.25
Monte Carlo. Canary-yellow	1/8 oz.	1.25	.25
Queen Alexandra. Rosy lilac	1/8 oz.	1.25	.25
Salmon King. Salmon-rose	1/8 oz.	1.25	.25
Souv. de Monaco. Crimson	1/8 oz.	1.25	.25
Summer Night. Deep blue	1/8 oz.	1.25	.25
Mixed Beauty of Nice Type	1/8 oz.	1.25	.25

**DOUBLE GIANT EXCELSIOR.** (Non-Branching). Each plant produces one large flowering spike.

Ball's White	.50
Deep Rose	.50
Lilac Lavender. Rich bright lavender	.50
Mixed	.50

**EARLY GIANT IMPERIAL** (Improved Bismarck). Very early blooming with high percentage of doubles. Height 2 1/2 to 3 1/2 ft.

Buttercup. New Giant Yellow	1/8 oz.	\$1.50	.25
Shasta. New Giant White	1/8 oz.	1.50	.25
Antique Copper. Hellebore-red	1/8 oz.	1.00	.25
Elk's Pride. Royal purple	1/8 oz.	1.00	.25
Finest Mixed	1/8 oz.	.75	.25

**STREPTOCARPUS.** Handsome greenhouse perennial, with Achimene-like flowers in clusters on slender stems. Treatment same as for Gloxinia.  
**Choice Mixed Hybrids** ..... Pkt. \$0.50

**SUNFLOWER.** H.A. Well-known hardy annuals, the small-flowering sorts being very useful for cutting, while the larger sorts are very ornamental and useful, blooming all Summer.

Double Californian. Deep yellow. 5 ft.	Oz. 50c.	.10
Single Russian. Enormous flowers. 6 ft.	Oz. 20c.	.10
Double Globe-shaped. Orange. 5 ft.	Oz. 35c.	.10
Chrysanthemum-flowered. Rich golden yellow flowers. 5 ft.	Oz. 60c.	.10
Single Red. "The Red Sunflower." Large flowers in various shades of red and dark centers. 6 ft.	1/4 oz. 25c.	.10

**CUCUMERIFOLIUS VARIETIES:**

cucumerifolius (Miniature Sunflower). Of pyramidal growth; covered with bright orange, small single flowers. 3 ft.	1/4 oz. 25c.	.10
cucumerifolius hybridus fl. pl. Splendid double and semi-double varieties. 3 ft.	1/4 oz. 30c.	.10
Marshall's "Excelsior" cucumerifolius Hybrids. Shades of red, purple, mahogany and yellow. 4 ft.	1/8 oz. 50c.	.10
Orion. A variety of Stello with twisted petals. 3 ft.	1/4 oz. 25c.	.10
Stello (Improved Miniature Sunflower). Yellow. 3 ft.	1/4 oz. 25c.	.10

**PERENNIAL VARIETIES:**

perennis Hybrids. Mixed hardy varieties. 3 ft.	1/8 oz. \$1.50	.25
questifolius, "Autumn Glory." H.P. The flowers are golden yellow. Plants grow about 6 ft. and bloom profusely in the late Fall	1/4 oz. \$1.00	.15

**SWEET PEAS.** (See page 34).

**SWEET ROCKET.** (See Rocket.)

**SWEET SULTAN.** (See Centaurea.)

**SWEET WILLIAM** (Dianthus barbatus). H.B. Showy, of easy culture; splendid for beds and borders with their rich varied flowers. 1 1/2 ft.

Crimson King. Crimson	1/4 oz. 50c.	.10
Diadem. A deep rich crimson, with white eye	1/4 oz. 50c.	.10
Giant White. Pure white	1/4 oz. 75c.	.10
Holborn Glory. Exceptionally large flowers, each showing a clear white eye. A good range of colors	1/4 oz. 75c.	.10
Newport Pink. Salmon-rose-pink flowers born on long stems.	1/4 oz. 75c.	.10



Thalictrum Adiantifolium



Sweet William, Single Mixed



Trollius Europaeus

**SWEET WILLIAM—Continued.**

- |   |              |        |
|---|--------------|--------|
| <b>Nigrescens.</b> Dark foliage and flowers. . . . .  | 1/4 oz. 75c. | \$0.10 |
| <b>Pink Beauty.</b> Very free flowering . . . . .   | 1/4 oz. 75c. | .10    |
| <b>Scarlet Beauty.</b> Intensely rich deep scarlet . . . . .                                | 1/4 oz. 75c. | .10    |
| <b>Single-flowering, Finest Mixed Colors</b> . . . . .                                      | 1/4 oz. 35c. | .10    |
| <b>Double-flowering, Mixed</b> . . . . .  | 1/4 oz. 50c. | .10    |
| <b>Single Annual Mixed.</b> Flowers of good size. Will bloom the first year. 12 in. . . . . | 1/4 oz. 50c. | .10    |
| <b>Collection of Sweet William.</b> Six varieties . . . . .                                 |              | .50    |
- 
- |   |              |     |
|---|--------------|-----|
| <b>TAGETES signata pumila.</b> H.A. A dwarf, bushy Marigold, with golden yellow flowers. Fine for bedding. 12 in. . . . . | 1/4 oz. 75c. | .10 |
|---|--------------|-----|
- 
- |  |              |     |
|--|--------------|-----|
| <b>THUNBERGIA.</b> H.A.C. Beautiful, rapid-growing climbers. 5 ft. . . . . |              |     |
| <b>Finest Mixed</b> . . . . .  | 1/4 oz. 50c. | .10 |
- 
- |  |                |     |
|--|----------------|-----|
| <b>TORENIA.</b> H.H.A. Tender trailing plants for vases or baskets. 12 in. . . . . |                |     |
| <b>Fournieri.</b> Velvety blue . . . . .   | 1/8 oz. \$1.00 | .15 |
| <b>"The Bride."</b> White and rose . . . . .                                       |                | .25 |
- 
- |  |                |     |
|--|----------------|-----|
| <b>THALICTRUM.</b> H.H.P. Graceful plants resembling Maiden-hair ferns. Extensively used for bouquets. . . . . |                |     |
| <b>adiantifolium.</b> Yellow flowers. 1 ft. . . . .  |                | .15 |
| <b>dipterocarpum.</b> Rosy-purple with citron-yellow anthers. 3 ft. . . . .                                    | 1/8 oz. \$1.00 | .25 |

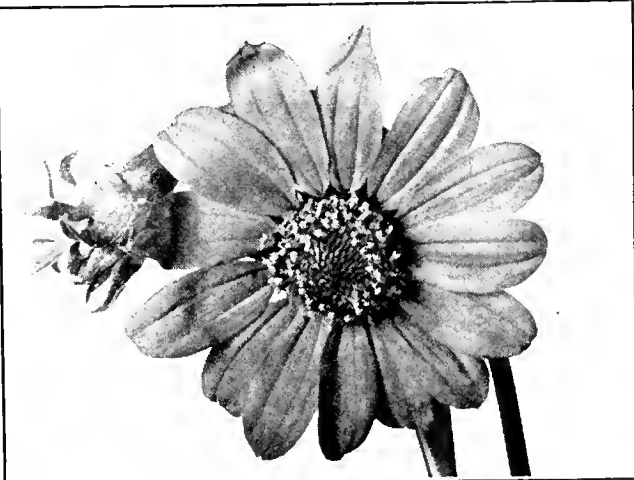

Tithonia Speciosa

- |  |      |        |
|--|------|--------|
| <b>TITHONIA speciosa.</b> (Mexican Sunflower.) H.H.A. Daisy-like, orange-colored flowers, 3 to 4 inches in diameter. Height 6 to 8 ft. . . . . | Pkt. | \$0.25 |
|--|------|--------|
- 
- |   |  |     |
|---|--|-----|
| <b>TRACHELIUM coeruleum.</b> G. P. A free-flowering plant with cloud-like heads of mauve flowers. 1 1/2 ft. . . . . |  | .25 |
|---|--|-----|
- 
- |  |  |     |
|--|--|-----|
| <b>TRITOMA.</b> H.H.P. Often called the Flame-flower, useful for borders and cutting. Plants should be well protected in winter. 3 ft. . . . . |  |     |
| <b>Stark's Early Hybrids.</b> A new perpetual flowering race. The colors embrace yellows and solmons to deep crimsons . . . . .                |  | .25 |
- 
- |   |  |     |
|---|--|-----|
| <b>TROLLIUS (Globeflower).</b> Charming Spring-flowering, hardy perennials with large, globular, Buttercup-like flowers varying in color from creamy white to orange. 2 ft. . . . . |  |     |
| <b>Orange Globe Hybrids.</b> Newest large-flowering varieties . . . . .   |  | .25 |
- 
- |  |  |  |
|--|--|--|
| <b>TROPAEOLUM Lobbianum.</b> (See Nasturtium.) . . . . . |  |  |
|--|--|--|
- 
- |   |                |     |
|---|----------------|-----|
| <b>URSINIA anethoides.</b> H.A. Daisy-like flowers, orange color with purple base. 12 in. . . . . | 1/8 oz. \$1.00 | .25 |
|---|----------------|-----|
- 
- |   |              |     |
|---|--------------|-----|
| <b>VALERIAN, Red.</b> H.P. Showy, hardy plant for the garden and rockery. 2 ft. . . . . | 1/4 oz. 30c. | .10 |
|---|--------------|-----|
- 
- |   |  |     |
|---|--|-----|
| <b>VENIDIUM fastuosum.</b> H.H.A. Flowers brilliant orange with dark center. 30 in. . . . . |  | .35 |
|---|--|-----|



Ursinia Anethoides

	Pkt.		Pkt.
<b>VERBENA.</b> H.A. The Verbena is a universal garden favorite, very few plants making a more gorgeous display of brilliant flowers from Spring till late in the Autumn. 12 in.		<b>VIOLA cornuta</b> (Tufted Pansies). H.H.P. Valuable for bedding and may be grown in the same manner as Pansies. Very free flowering. 6 in.	
<b>grandiflora erecta, Royal Bouquet.</b> A valuable decorative plant for bedding or growing in pots. Mixed colors . . . . .	\$0.25	<b>Admiration.</b> Soft purple, dark blotched . . . . .	1/8 oz. 75c. \$0.15
<b>hybrida colossea, Etna.</b> Garnet-red . . . . .	.15	<b>Apricot.</b> An unusually fine shade blending into deep orange. . . . .	.25
<b>hybrida colossea, Rose Cardinal.</b> Rose, white eye . . . . .	.15	<b>Arkwright Ruby.</b> A fine red shaded with terra-cotta. Compact habit and very fragrant . . . . .	.25
<b>hybrida colossea, Royale.</b> Deep royal blue . . . . .	.15	<b>Haslemere.</b> A distinct variety with rosy-lilac flowers. A good rock plant . . . . .	.25
<b>hybrida gigantea, Mixed.</b> A greatly improved strain producing giant florets in many colors . . . . .	1/4 oz. \$1.00 .15	<b>Jersey Gem.</b> The flowers are a pleasing shade of deep violet-blue . . . . .	.35
<b>Mammoth candidissima.</b> Large trusses of white flowers. . . . .	1/4 oz. 75c. .10	<b>lutea grandiflora.</b> Orange . . . . .	1/8 oz. 75c. .15
— <b>coerulea.</b> Bright blue and purple in various shades. . . . .	1/4 oz. 75c. .10	<b>Mauve Queen.</b> Pretty mauve . . . . .	1/8 oz. 75c. .15
<b>Helen Willmott.</b> A very pretty bright salmon rose, with white eye . . . . .	1/4 oz. \$1.00 .15	<b>White Perfection.</b> The best white . . . . .	1/8 oz. 75c. .15
— <b>Lucifer.</b> Intense brilliant scarlet with no eye . . . . .	1/4 oz. 75c. .10	<b>Finest Mixed.</b> All colors . . . . .	1/4 oz. \$1.00 .15
— <b>Mayflower.</b> A beautiful pink variety . . . . .	1/4 oz. 75c. .10	<b>VIOLET, Viola odorata.</b> H.P. Sweet-scented Violet, blue. 6 in. . . . .	.25
— <b>Yellow.</b> Primrose color . . . . .	1/4 oz. 75c. .10	<b>VISCARIA.</b> H.A. Showy and profuse blooming plants, very effective in small beds or borders.	
— <b>Finest Mixed.</b> Extra choice . . . . .	1/4 oz. 50c. .10	<b>Finest Mixed</b> . . . . .	1/4 oz. 35c. .10
<b>Beauty of Oxford Hybrids.</b> Shades of rose-pink to rose-red. Very large flowers . . . . .	.25	<b>WALLFLOWER.</b> H.H.P. Old-fashioned fragrant plants blooming in early Spring. They should be protected in a cold frame in the Winter, and planted out in April. 12 in.	
<b>erinoides.</b> A consistent bloomer, suitable for bedding, produces a mass of moss-like foliage. Flowers purplish blue. . . . .	1/4 oz. 50c. .10	<b>Allioni</b> (Alpine Wallflower). (See <b>Cheiranthus</b> .)	
<b>venosa.</b> Purple flowers. Blooms the first year from seed. . . . .	1/4 oz. 50c. .15	<b>Kewensis.</b> Very fragrant, sulphur-yellow flowers, passing to orange-yellow and purple-violet. Fine for Winter flowering in greenhouse . . . . .	1/8 oz. 75c. .15
<b>Lemon Verbena</b> ( <i>Alôysia citriodora</i> ). Lemon-scented leaves. . . . .	.15	<b>Single Fine Mixed.</b> Hardy varieties . . . . .	1/4 oz. 35c. .10
<b>VERBASCUM Miss Willmott.</b> H.P. A lovely hardy plant with large, ivory-white spikes of flowers. 5 ft. . . . .	.25	<b>Double Fine Mixed.</b> Hardy . . . . .	1/8 oz. \$1.00 .25
<b>phoeniceum.</b> H.P. Various colors, including white, pink, blue, mauve and purple. 12 in. . . . .	1/4 oz. 50c. .15	<b>Annual Varieties.</b> If sown in heat during March these will flower during the Summer and Autumn. Excellent for forcing.	
<b>VERONICA.</b> H.P. Splendid, hardy perennials with showy spike of bright-colored flowers; fine border plant. 1 1/2 to 2 ft.		<b>Annual Mixed. Single.</b> Summer flowering . . . . .	1/4 oz. 50c. .10
<b>spicata, Blue.</b> Bright blue . . . . .	1/4 oz. 50c. .15	<b>Early Paris Market.</b> Bright brown . . . . .	1/4 oz. 50c. .10
<b>VINCA.</b> H.H.P. Splendid plants for bedding and edging; glossy, dark-green foliage and pretty pink and white flowers. 2 ft.		<b>Blood-red.</b> Single . . . . .	1/4 oz. 50c. .10
<b>alba pura.</b> Pure white . . . . .	1/4 oz. 60c. .10	<b>Early Wonder.</b> A new double annual flowering type. Mixed colors . . . . .	1/4 oz. \$1.00 .15
<b>alba rosea.</b> White, crimson eye . . . . .	1/4 oz. 60c. .10	<b>WILD CUCUMBER.</b> (See <b>Echinocystis</b> .)	
<b>rosea.</b> Rose, dark eye . . . . .	1/4 oz. 60c. .10	<b>XERANTHEMUM.</b> H.A. Showy, hardy annual of easy culture, giving a profusion of flowers; well suited to drying as everlasting. 1 1/2 to 2 ft.	
<b>Mixed</b> . . . . .	1/4 oz. 60c. .10	<b>Double Mixed</b> . . . . .	1/4 oz. 35c. .10



Viola Cornuta  
Sweet Peas and Flower Seeds treated with "SEMESAN" will give better germination.

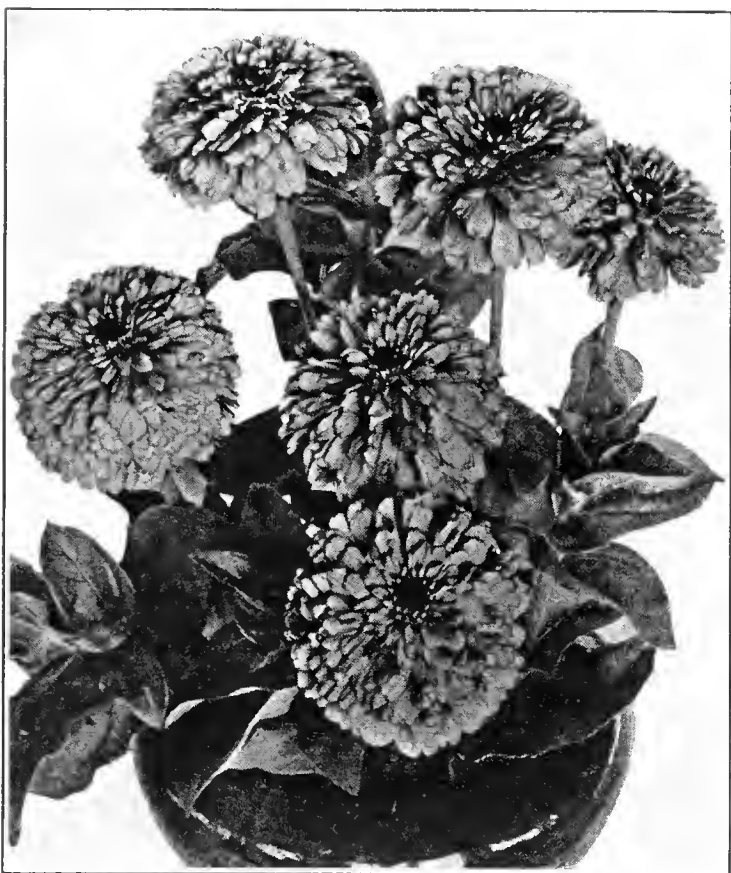

Zinnia Elegans Pumila, Salmon Rose.



California Giant Zinnias.

# ZINNIAS

(Youth and Old Age). H.A.

These well-known garden favorites are one of the most brilliant summer-flowering plants. The flowers are large, very handsome, and borne in great profusion. They succeed best in a sunny situation.

- ELEGANS PUMILA. Dwarf Double.** (Cut-and-Come-Again). A good type of Zinnias for cut flowers and borders, growing about 18 inches high. Pkt.
- Canary Yellow ..... ¼ oz. 50c. \$0.10
  - Flesh ..... ¼ oz. 50c. .10
  - Golden Orange ..... ¼ oz. 50c. .10
  - Salmon Rose ..... ¼ oz. 50c. .10
  - Scarlet ..... ¼ oz. 50c. .10
  - Snowball. White ..... ¼ oz. 50c. .10
  - Finest Mixed ..... ¼ oz. 35c. .10
  - Collection, one packet each, 6 colors ..... .50

- CALIFORNIA GIANTS.** This type has enormous flowers that are flat, eliminating the stiffness that has been objectionable in the past. 3½ feet.
- Enchantress. Light rose ..... ¼ oz. 60c. .15
  - Grenadier. Dark red ..... ¼ oz. 60c. .15
  - Lavender Gem. Lavender ..... ¼ oz. 60c. .15
  - Miss Willmott. Soft pink ..... ¼ oz. 60c. .15
  - Orange King. Burnt orange ..... ¼ oz. 60c. .15
  - Orange Queen. Golden yellow ..... ¼ oz. 60c. .15
  - Purity. White ..... ¼ oz. 60c. .15
  - Salmon Queen. Old rose shade ..... ¼ oz. 60c. .15
  - Finest Mixed. All colors ..... ¼ oz. 60c. .15

- FANTASY MIXED.** Shaggy, raylike petals, in a wide range of colors. 2½ to 3 ft. .... ¼ oz. \$1.00 .25

- GIANT DAHLIA-FLOWERED.** These are similar to the Double Dahlia in size and shape of flowers. 2½ ft.
- Canary Bird. Rich canary-yellow ..... ¼ oz. 60c. .15
  - Crimson Monarch. Largest of the red shades.. ¼ oz. 60c. .15
  - Dream. Deep lavender, turning to purple ... ¼ oz. 60c. .15
  - Exquisite. Light rose, with center a deep rose. ¼ oz. 60c. .15
  - Golden Dawn. Golden yellow ..... ¼ oz. 60c. .15
  - Oriole. An orange and gold bicolor, turning to deep orange ..... ¼ oz. 60c. .15
  - Polar Bear. A very large pure white ..... ¼ oz. 60c. .15
  - Scarlet Flame. A large, beautiful bright scarlet. ¼ oz. 60c. .15
  - Dahlia-flowered Mixed ..... ¼ oz. 60c. .15
  - Collection of eight varieties ..... 1.00

- LILLIPUT.** Small double flowers for borders, bedding and cut flower purposes. Makes a bushy plant one foot high.
- Golden Gem ..... ¼ oz. 50c. .10
  - Purple Gem ..... ¼ oz. 50c. .10
  - Salmon Rose ..... ¼ oz. 50c. .10
  - Scarlet Gem ..... ¼ oz. 50c. .10
  - White Gem ..... ¼ oz. 50c. .10
  - Finest Mixed ..... ¼ oz. 50c. .10

- SCABIOUS FLOWERED MIXED.** Medium sized flowers resembling an annual Scabious. 2 to 2½ ft. .... ¼ oz. \$1.00 .25

- TALL DOUBLE MIXED.** Very double; a fine strain. ¼ oz. 50c. .10

- HAAGEANA "PERFECTION (Mexicana).** Small double flowers in many colors, makes a beautiful border. 9 in. Finest mixed ..... ¼ oz. \$1.00 .25

- VICTORY.** A very distinct variety with large, densely double, quilled flowers, the colors are mostly in russet, orange, old rose and other autumn tints ..... ¼ oz. 60c. .15

## WILD GARDEN FLOWER SEEDS

This mixture contains over 100 varieties of the oddest and choicest annuals imaginable. For naturalizing purposes or sowing broadcast, nothing approaches wild garden flower seeds for effect and cheapness. No care is necessary, and a never-ending succession of bloom and fragrance can be obtained throughout the entire summer and fall. Pkt. 10c, oz. 25c, ¼ lb. 75c.

# Marshall's Spencer Sweet Peas

Sow as soon as the ground can be worked in the Spring in trenches at least 6 inches in depth, then as the plants grow fill in the soil about one inch at a time until the trenches are full, taking care not to cover the young plants. Liquid manure applied occasionally will be found very beneficial.

Keep well watered during dry periods and spray periodically to prevent injury from green fly or aphids.

In view of the numerous Sweet Pea introductions this list has been again revised and includes those varieties which trials have proved to be the best in the various colors.

- |  |   |
|--|---|
| <p><b>BLUE</b><br/> <b>AMETHYST.</b> Amethyst-blue.<br/>                 *<b>GLENEAGLES.</b> Light blue.<br/> <b>THE ADMIRAL.</b> Navy blue.<br/> <b>COMMANDER GODSALL.</b> Violet-blue.<br/> <b>REFLECTION.</b> Clear blue.</p> <p><b>CARMINE</b><br/> <b>DAMASK ROSE.</b> Bright rose-carmine.<br/> <b>DOREEN.</b> Large flower.</p> <p><b>CERISE</b><br/> <b>BEAT ALL.</b> Pale cerise suffused salmon.<br/> <b>CHARMING.</b> Deep cerise.<br/>                 *<b>MRS. A. SEARLES.</b> Salmon-cerise.<br/> <b>FLAMINGO.</b> Orange-scarlet shaded cerise.</p> <p><b>CREAM</b><br/>                 *<b>WHAT JOY.</b> Deep cream; frilled.<br/> <b>DAFFODIL.</b> Deep cream.</p> <p><b>CRIMSON</b><br/>                 *<b>RED BOY.</b> The very best crimson.<br/> <b>CRIMSON KING.</b> Oxblood-crimson.</p> <p><b>LAVENDER</b><br/>                 *<b>AMBITION.</b> Rich deep lavender.<br/> <b>POWERSCOURT.</b> Clear lavender.<br/> <b>AUSTIN FREDERICK IMP.</b> Large, clear lavender.</p> <p><b>MAROON</b><br/> <b>WARRIOR.</b> Rich chocolate-maroon.<br/> <b>THE SULTAN.</b> Glossy black-maroon.</p> | <p><b>MAUVE</b><br/> <b>INTERNATIONAL.</b> Rosy mauve.<br/> <b>CHIEFTAIN.</b> Deep mauve.</p> <p><b>ORANGE</b><br/>                 *<b>PIRATE GOLD.</b> Golden orange.<br/> <b>GEORGE SHAWYER.</b> Giant orange-pink.</p> <p><b>PICOTEE</b><br/>                 *<b>YOUTH.</b> White picotee edged rose.<br/> <b>SUNKIST.</b> Cream picotee edged rose.</p> <p><b>PINK</b><br/>                 *<b>PINKIE.</b> Rose-pink frilled.<br/> <b>MAGNET.</b> Best cream-pink.<br/> <b>ASCOT.</b> Clear deep pink, waved.<br/> <b>JACK HOBBS.</b> Cream-pink flushed scarlet.<br/> <b>MAYFAIR.</b> Shell-pink.<br/> <b>SUPREME.</b> Pale pink.</p> <p><b>PURPLE</b><br/>                 *<b>OLYMPIA.</b> Deep rich purple.</p> <p><b>SALMON</b><br/>                 *<b>SMILES.</b> Clear glittering salmon.<br/> <b>BARBARA.</b> Salmon-orange.<br/> <b>IDYL.</b> Salmon-pink.</p> <p><b>SCARLET</b><br/>                 *<b>WELCOME.</b> Dazzling scarlet.<br/> <b>HUNTSMAN.</b> Bright scarlet.</p> <p><b>WHITE</b><br/>                 *<b>AVALANCHE.</b> Glistening white frilled.<br/> <b>WHITE SPENCER.</b> White seeded.</p> |
|--|---|

Any of the above varieties: Pkt. 10c., oz. 50c., 1/4 lb. \$1.50

### MARSHALL'S TWELVE EXHIBITION VARIETIES

We have selected the following twelve varieties as being the best of the above list of Sweet Peas for exhibition purposes.

- |  |   |
|--|---|
| <p><b>Ambition</b><br/> <b>Avalanche</b><br/> <b>Gleneagles</b><br/> <b>Mrs. A. Searles</b><br/> <b>Olympia</b><br/> <b>Pinkie</b></p> | <p><b>Pirate Gold</b><br/> <b>Red Boy</b><br/> <b>Smiles</b><br/> <b>Welcome</b><br/> <b>What Joy</b><br/> <b>Youth</b></p> |
|--|---|

One Pkt. each of the above 12 Exhibition Varieties for \$1.00.

### MARSHALL'S MATCHLESS MIXED SPENCER HYBRIDS

This mixture is grown from a special formula which has been built up and perfected during a great many years. It contains over 75 standard varieties, and in addition, all the best Novelties of the past year. The color blend is, we believe, as near perfection as it is possible to attain.

Pkt. 10c., oz. 35c., 1/4 lb. 85c., 1/2 lb. \$1.50, lb. \$2.50.

**CUPID, GRANDIFLORA or DWARF SWEET PEAS.** These grow about 9 inches high and are adapted for borders or beds. **Finest Mixed Colors.** Pkt. 10c; oz. 30c; 1/4 lb. \$1.00.

### INOCULATE SWEET PEAS WITH LEGUME CULTURE

Sweet Peas will flower earlier, longer and better if inoculated with Legume Culture when planted. Small size, 30c.; large size, 60c.

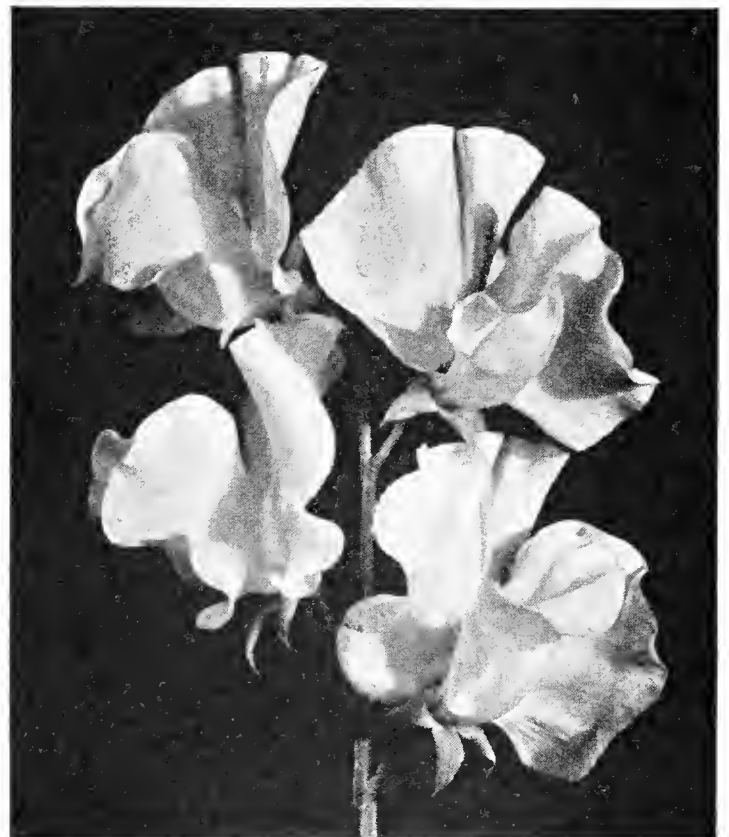

## Marshall's Early Flowering Spencer Sweet Peas

The Early Flowering Spencers bloom about two weeks earlier than the late flowering varieties when grown under congenial conditions. The flowers are beautifully waved and produced on long stems, four flowers predominating on each stem. For winter flowering under glass or in the southern states they far surpass the Late Spencers. When grown in the open ground they will usually bloom in about 100 days after planting.

- Amethyst.** Royal purple.
- \***Annie Laurie.** Pure rose-pink.
- \***Ball Rose.** Rose-pink.
- \***Blue Bonnet.** Clear deep blue.
- \***Exposition Pink.** Rich pink.
- Giant Rose.** Rose-pink.
- Glitters.** Cerise.
- Grenadier.** Dazzling scarlet.
- Harmony.** Clear lavender.
- \***Hope.** Pure white, black seeded.
- \***Jeanne Mamitsch.** Rose-pink, long stems.
- \***Lady Gay.** Soft shrimp-pink.
- \***Lavanda.** Finest clear lavender.
- \***Majestic Rose.** Brilliant rose-pink.
- \***Mrs. Herbert Hoover.** Clear blue.
- Mrs. Kerr.** Salmon.
- \***Red Bird.** Bright crimson-red.
- Silver King.** Light campanula blue.
- Snowstorm Improved.** Pure white.
- Sweet Lavender.** Pure lavender self.
- \***Valencia.** Sun-proof orange.
- White Harmony.** White, black seeded.
- Yarrowa.** Bright rose-pink.
- Zvolanek's Blue Sensation.** Clear blue.
- Zvolanek's Orange.** Orange.
- Early Flowering Mixed.** Oz. 75c.

Each of the above varieties except where priced: Pkt. 15c; oz. \$1.00.

Varieties marked with \* we submit as being the twelve best varieties in their respective class.

# Specialties in Vegetables

## BEAN

**The Prince.** An extremely long podded English variety, producing a wonderful crop of tender green beans. For exhibition or home garden it cannot be excelled.  $\frac{1}{2}$  lb. 60c, lb. \$1.00, 2 lbs. \$2.00

## BEET

**Early Red Beauty.** A perfectly round shaped, fast growing and pure dark fleshed variety. The roots are smooth, uniform in shape with slender tap root. Pkt. 10c, oz. 30c,  $\frac{1}{4}$  lb. 75c, lb. \$2.50.

**Non-Bleeding.** A medium sized, long, smooth root. Very dark red flesh which does not bleed when cooked. Foliage dark red. Pkt. 10c, oz. 25c,  $\frac{1}{4}$  lb. 75c, lb. \$2.50.

## CARROT

**Imperator.** Received the All-America Award at Merit. An outstanding type for garden use. Tops medium, roots smooth, deep rich orange; uniformly tapering to a semi-blunt end. Pkt. 10c, oz. 25c,  $\frac{1}{4}$  lb. 75c, lb. \$2.00.

## CORN

**Marshall's Early Golden Sugar.** An introduction from Canada of distinct merit. The golden ears are six inches long, eight rowed, very sweet and 10 days earlier than Golden Bantam. Height only 4 feet. An excellent variety for the home garden. Pkt. 15c,  $\frac{1}{2}$  lb. 30c, lb. 50c, 2 lbs. 90c.

**Spancross C. 2.** A new Hybrid variety that is blight and disease resistant. It is the earliest of the Hybrid varieties. Produces 10 to 16-rowed ears, slightly tapering, 6 to 8 inches long. Kernels are very sweet. Height about 6 feet.  $\frac{1}{2}$  lb. 40c, lb. 70c, 2 lbs. \$1.30.

**Midget.** A dwarf Sweet Corn growing about 30 inches high. Delicate small ears 3 to 4 inches long with very sweet white kernels. Suitable for growing under glass or the small home garden. Pkt. 25c.

**Spanish Dawn.** Originated by our grower, matures 6 to 7 days earlier than Golden Bantam. Ears about 8 inches long with 12 to 16 rows of delicious yellow kernels, very sweet. Foliage wilt proof.  $\frac{1}{2}$  lb. 30c, lb. 50c, 2 lbs. 95c.

## CUCUMBER

**Chinese Long.** A remarkable Cucumber from China. The fruits are very long, 12 inches and over. The flesh is very tender, white, excellent for slicing and salads. Pkt. 10c, oz. 50c,  $\frac{1}{4}$  lb. \$1.50

## LETTUCE

**Marshall's Matchless.** The sweetest and most delicate flavored variety in existence. It is a cross between a head variety and the Cos type with leaves resembling a deer tongue. When once you have tried this exquisite variety you will grow no other. Pkt. 25c, oz. \$1.00.

## MELON

**Marshall's Matchless.** A very large and distinctively ribbed and netted variety. Orange-scarlet flesh, very thick and of a luscious flavor. Very small seed cavity. Pkt. 25c, oz. \$1.00.

## PEA

**The President.** A very productive variety growing 20 to 22 inches high. Pods  $4\frac{1}{2}$  inches long, dark green, straight and peas of sweet flavor and quality.  $\frac{1}{2}$  lb. 25c, lb. 40c, 2 lbs. 80c, 8 lbs. \$3.00.

**Sugarstick or Paramount.** The pods are used in salads or cooked separately without shelling. The fleshy 6-inch pods are curved and free from fiber. Height 4 feet. Pkt. 25c,  $\frac{1}{2}$  lb. 75c, lb. \$1.30.

## RADISH

**Marshall's Glowing Ball.** It has a perfect round shape and small top, color a bright fiery scarlet-red with a suffusion of orange. Pkt. 10c, oz. 30c,  $\frac{1}{4}$  lb. 75c.

**Comet.** A perfect ball-shaped variety, color bright scarlet, remains crisp until very large. Pkt. 10c, oz. 25c,  $\frac{1}{4}$  lb. 60c, lb. \$2.00.

## TOMATO

**Penn State.** Originated by the Penn State College and Agricultural Station. The fruit is of medium size, rather globular shape, with a rich uniform scarlet color. Very early and of compact growth. Pkt. 15c,  $\frac{1}{2}$  oz. 50c, oz. \$1.00.

**Tangerine.** A main crop variety similar in color to a tangerine. The thin skin is a beautiful orange and the flesh a lighter shade of orange. The fruit is rich and sub-acid. A very strong grower. Pkt. 25c,  $\frac{1}{2}$  oz. \$1.00, oz. \$1.75.



Imperator Carrot

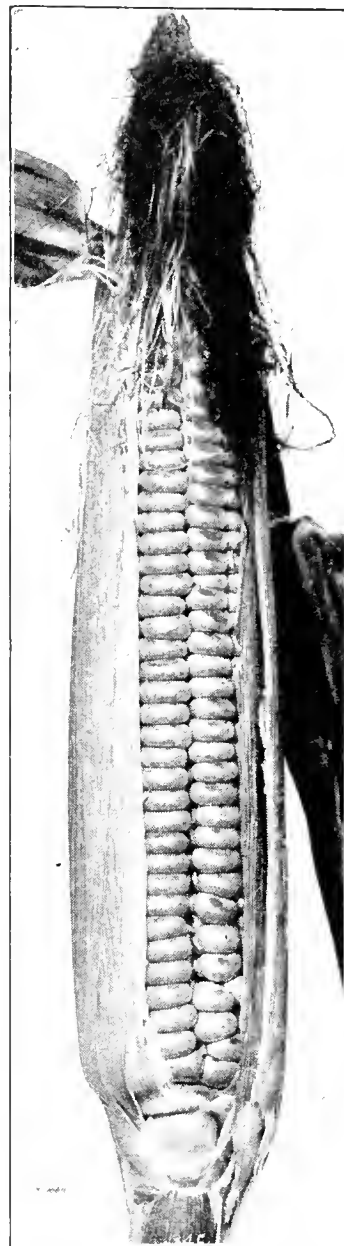

Early Golden Sugar Corn

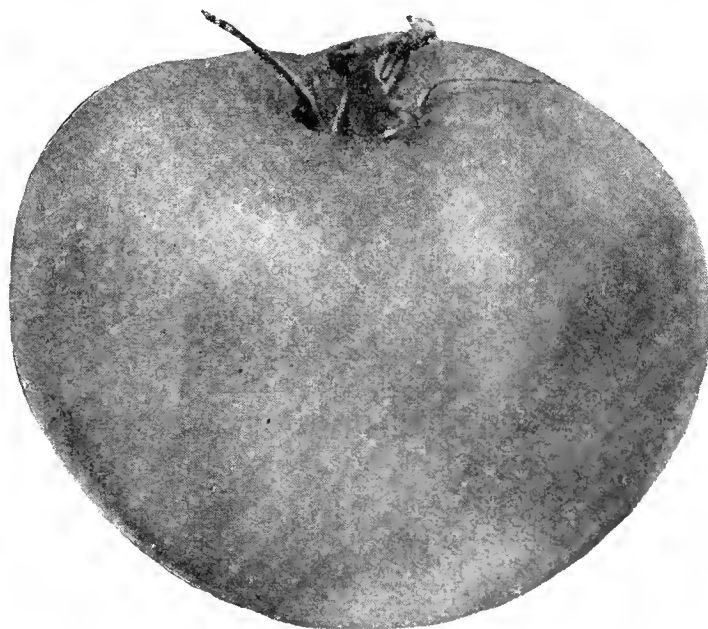

Penn State Tomato

# Marshall's Vegetable Seeds

**With General Directions for Cultivation**

"The W. E. Marshall & Co., Inc., give no warranty, express or implied, as to the description, quality, productiveness or any other matter of any seeds or bulbs it sells and will not be responsible for the crop."

**ARTICHOKE**

**One ounce will sow 100 feet of row, and produce about 500 plants.**  
 A rich, sandy loam is best adapted for this plant. The seed should be sown in drills 1½ inches deep and 1 foot apart. Transplant to rows 3 feet apart. They reach maturity the second year. Protect in Winter by a covering of leaves or coarse manure.  
**Large French Globe.** Heads large, fleshy and of rich flavor. Pkt. 25c, ½ oz. 60c, oz. \$1.00.

**ARTICHOKE PLANTS**

**Large French Globe.** Plants ready for shipment after April 1st. Doz. \$2.50, 100 \$20.00.  
**Jerusalem.** Grown for the tubers, which resemble Potatoes, and are cultivated in a similar manner, but the rows should be at least 4 feet apart. Qt. 40c, peck \$2.50.

**ASPARAGUS**

**One ounce will produce about 200 plants.**  
 Sow in Autumn or in Spring as soon as the soil is in good working condition. At one or two years transplant to permanent beds.  
 Pkt. Oz. ¼ lb.  
**Palmetto.** A fine variety, producing large, green Asparagus .....\$0.10 \$0.20 \$0.45  
**Giant Washington.** A rust resistant variety, with long, dark green stalks..... .10 .50 1.50

**ASPARAGUS ROOTS**

It requires 100 plants for a single row of 150 feet.

**Culture.**—The permanent bed should be trenched or ploughed very deeply, and well manured with rich, thoroughly decayed manure. Set the plants 18 inches apart in rows, carefully spreading out and separating the roots and deep enough to admit of the top of the plants being covered 6 inches. In November the plants should have their annual top-dressing of manure after the stalks have been cleared away.

**THREE-YEAR-OLD ROOTS** 100 1000  
**Mary Washington.** Dark green .....\$4.00 \$35.00

**TWO-YEAR-OLD ROOTS** 25 100 1000  
**Mary Washington** .....\$1.00 \$3.00 \$25.00

**Note.**—Varieties other than Mary Washington have been discontinued as there is no demand for same.

**BEANS**

Beans like a well drained, rich and light loam. Plant about the middle of April when warm and favorable, and at intervals throughout the season for a succession, until the latter part of August. Bush varieties should be planted in drills 2 feet apart, and from two to six plants to the foot in a row. Keep them well cultivated and draw the earth up to the stem. For String Beans gather the pods as soon as fit for use.

**DWARF SHELL BEANS**

Sow in drills 2 feet apart as soon as warm weather has set in; soil should be light and rich; covering beans with about 2 inches of soil.

	½ lb.	Lb.	2 lbs.	8 lbs.
<b>Boston Pea or Navy.</b> Used when dry for cooking purposes .....	\$0.20	\$0.30	\$0.60	\$2.00
<b>Red Kidney.</b> Similar to White Kidney, except the beans are deep red.....	.20	.30	.60	2.00
<b>English Green Windsor.</b> A nutritious, large Bean growing 3 feet high on stiff stems. Should be planted very early .....	.30	.50	.90	3.25

**DWARF GREEN-PODDED BEANS**

One quart will plant 150 feet of drill.

	½ lb.	Lb.	2 lbs.	8 lbs.
<b>Black Valentine, Stringless.</b> The pods are not quite as round as the old type, but are free from strings.....	\$0.25	\$0.40	\$0.75	\$3.00
<b>Bountiful.</b> Early, very prolific and long bearing; flat, green pods, tender and stringless .....	.25	.45	.80	2.75
<b>Canadian Wonder.</b> Large, green pods. Fine for table or exhibition.....	.25	.50	1.00	3.75

	½ lb.	Lb.	2 lbs.	8 lbs.
<b>Extra Early Red Valentine.</b> One of the earliest. Round, thick, solid pods ...	\$0.25	\$0.40	\$0.75	\$2.50
<b>Giant Stringless Green Pod.</b> This bean is absolutely stringless. The pods are round and full .....	.25	.40	.80	3.00
<b>Masterpiece.</b> This bean is well named as it is a masterpiece in this section of vegetables. Round, firm, straight, stringless pods of luscious flavor. Superb for forcing and exhibition...	.35	.60	1.10	4.00
<b>Refugee, Late, or 1000 to 1.</b> Medium to late; very productive and tender. Largely grown for main crop; round pod .....	.20	.35	.70	2.50
<b>Stringless Green Pod.</b> An early, round, green-podded Bean; stringless, remains tender and crisp.....	.25	.45	.80	2.75
<b>The Prince.</b> Extremely long podded. A very heavy cropper and the finest for exhibition or general purposes...	.60	1.00	2.00	7.00
<b>Tendergreen.</b> One of the best round green podded beans. Stringless fleshy pods .....	.30	.50	.90	3.25

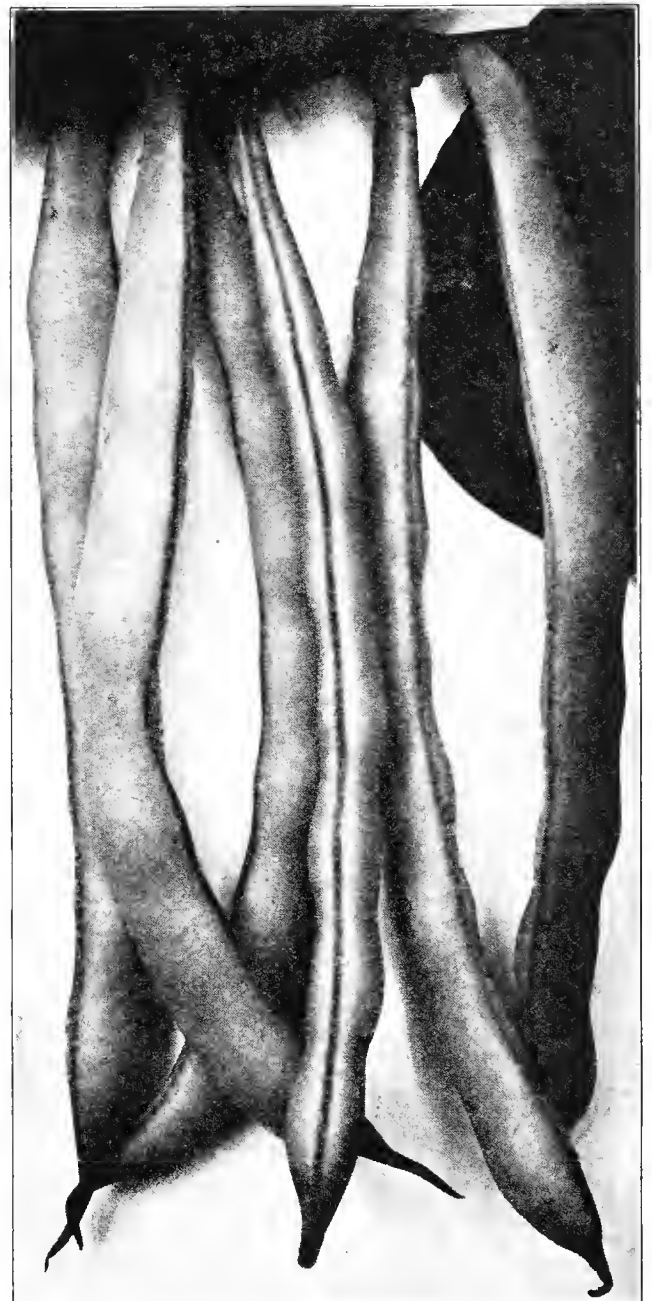

Bountiful Beans



**DWARF WAX-PODDED BEANS**

	1/2 lb.	Lb.	2 lbs.	8 lbs.
<b>Black Wax, Currie's Rust-Proof.</b> Large, flat pods; early.....	\$0.20	\$0.35	\$0.70	\$2.50
<b>Brittle Wax, or Round Pod Kidney Wax,</b> Round podded, stringless.....	.25	.40	.80	3.00
<b>Golden Wax, Improved.</b> Very early; flat pods, long, stringless.....	.25	.40	.80	2.50
<b>Golden Scimitar, or Pencil-Pod Black Wax.</b> Long, round, yellow, stringless pods.....	.25	.40	.80	3.00



Golden Wax, Improved

	1/2 lb.	Lb.	2 lbs.	8 lbs.
<b>Hodson Wax (Valentine Wax).</b> Hand-some, thick, flat, yellow pods. Free from blight and rust. Heavy bearer..	\$0.25	\$0.40	\$0.80	\$3.00
<b>Wardwell's Kidney Wax.</b> Early; long, straight, flat, wax, stringless pods..	.25	.40	.80	3.00

**DWARF, OR BUSH LIMA BEANS**

	1/2 lb.	Lb.	2 lbs.	8 lbs.
<b>Burpee's Improved Bush Lima.</b> A bush form of the large, flat Pole Lima..	\$0.25	\$0.40	\$0.80	\$3.00
<b>Dreer's Bush Lima.</b> Round, thick Beans; very prolific.....	.25	.45	.90	3.25
<b>Fordhook Bush Lima.</b> It is of erect habit; Beons very large, and heavy cropper.....	.30	.50	1.00	3.75
<b>Henderson's Bush Lima, or Dwarf Sieva.</b> Very early small type with pods about 3 inches long.....	.25	.40	.80	3.00
<b>Wilson's Improved Bush Lima.</b> A week to ten days earlier than Burpee's, more productive but not quite so large.....	.25	.45	.90	3.25

**POLE, OR RUNNING BEANS**

Sow from the 1st of May (for all except Limas) to the latter part of May, in hills 4 feet each way. Limas should not be planted until warm weather has fairly set in. One quart of Limas will plant about 100 hills, allowing four or five beans to a hill, and of the smaller sorts about 200 hills. Poles 8 to 10 feet long should be firmly set in the hills before planting seed. Set poles 4 feet apart each way, and plant 4 to 6 beans about 1 inch deep around each pole. Thin out to three plants to a pole if the soil is rich; pinch off the ends of plants when they overrun the top of the poles, to effect more perfect growth below.

	1/2 lb.	Lb.	2 lbs.	8 lbs.
<b>Carpinteria Lima.</b> The beans have a greenish tint; vines vigorous and very productive. A perfect Lima bean..	\$0.25	\$0.40	\$0.80	\$3.00
<b>Challenger Lima.</b> Thick and productive. Best of all.....	.25	.40	.80	3.00
<b>Leviathan Lima, or Early Jersey.</b> The earliest variety of pole Lima. Produces pods in clusters. A good variety where the season is short.....	.25	.40	.80	3.00
<b>Marshall's Giant-Podded Pole Lima.</b> A rapid growing, very large podded variety. The beans are extra large and thick.....	.30	.50	1.00	3.50
<b>Small Sieva, or Carolina Lima.</b> Small size; early and prolific.....	.25	.40	.80	3.00
<b>Ideal Market Pole.</b> The earliest and most prolific, round, green podded, stringless bean.....	.25	.40	.80	3.00
<b>Kentucky Wander (Old Homestead).</b> Pods green, very long and flat.....	.25	.40	.80	3.00
<b>Kentucky Wonder Wax.</b> Very early, long, thick, fleshy pods.....	.25	.40	.80	3.00
<b>Scarlet Runner.</b> A popular English pole bean; very ornamental.....	.25	.40	.80	3.00

Inoculate This Seed With STIMUGERM

The use of "Stimugerm" when planting Beans will increase your yields. Sm. size 25c, bu. size 35c.

**BROCCOLI OR CALABRESE**

(For Cultural Directions, see Cauliflower.)

	Pkt.	Oz.	1/4 lb.
<b>White Cape.</b> Heads compact and of a creamy white color.....	\$0.10	\$0.75	\$2.50

	Pkt.	Oz.
<b>Marshall's Green Heading.</b> This luscious and nutritious vegetable should be in every garden. It ranks at the top of the list of health giving vegetables. Our strain forms branching plants with small heads. Matures in September and later.....	\$0.15	\$1.25

**BRUSSELS SPROUTS**

One ounce will produce about 2000 plants.

Sow in May in shallow drills 1 inch deep and 12 inches apart; transplant in July. A very hardy, delicious vegetable which should find a place in every garden; greatly improved by hard frosts.

	Pkt.	1/2 oz.	Oz.	1/4 lb.
<b>Marshall's Exhibition.</b> The finest variety of all the Brussels Sprouts. Very large and of superior quality.....	\$0.15	\$0.50	\$1.00	\$3.00
<b>Long Island Improved.</b> Solid, round sprouts of the best quality.....	.10	.30	.60	2.00

Marshall's Green Heading Broccoli

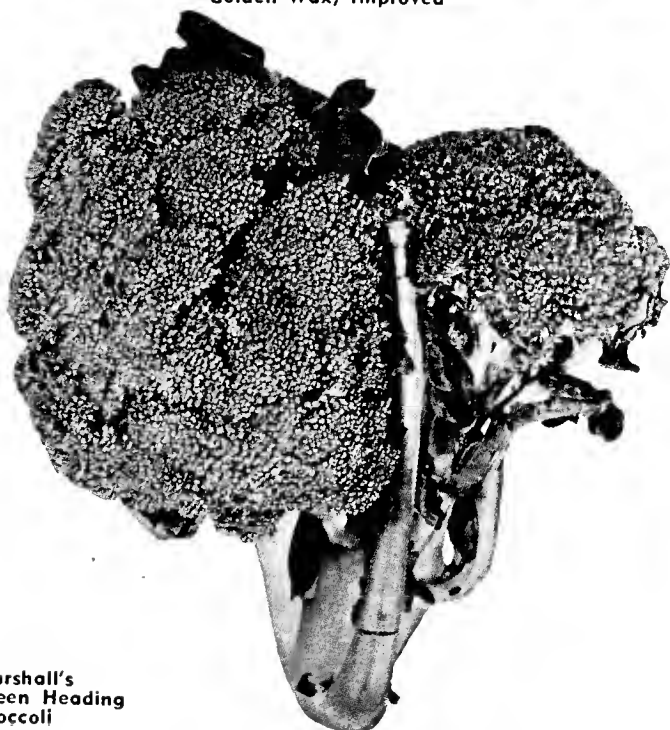

**BEET**

One ounce will sow 150 feet of drill.

For early supply sow as soon as the ground is in working order, in drills 1 foot apart and 2 inches deep. For main crop sow the second week in May, and for Winter use sow in June. When the plants are well forward thin out to about 9 inches apart. The young Beets, with their tops, pulled out of the row, are excellent, used as Spinach.

	Pkt.	Oz.	¼ lb.	Lb.
<b>Early Blood Turnip.</b> The leading early sort; also fine for late use.....	\$0.10	\$0.25	\$0.65	\$1.50
<b>Early Red Beauty.</b> The color is a deep dark red. Roots smooth, perfectly globular and uniform size .....	.10	.30	.75	2.50
<b>Extra Early Egyptian.</b> The root is very dark red, flat.....	.10	.25	.65	1.50
<b>Crosby's Egyptian.</b> Extra early, round, dark red .....	.10	.25	.65	1.50
<b>Crimson Globe.</b> Fine globular shape; flesh deep purple; fine quality....	.10	.25	.65	1.50
<b>Detroit Dark Red Turnip.</b> Round; skin dark blood red; flesh bright red...	.10	.25	.65	1.75
<b>Marshall's Exhibition Globe.</b> Very carefully selected stock. Dark red and the finest shaped Globe variety.....	.10	.30	.75	2.50
<b>Non-Bleeding.</b> Very dark red flesh and does not bleed when cooked. Roots long and medium size .....	.10	.25	.75	2.50
<b>Perfected Detroit.</b> Tops tall green and red. Roots globular, smooth and deep red color .....	.10	.25	.75	2.50
<b>Winter Keeper.</b> Almost globe shaped, flesh dark red, sweet and tender. A good winter keeping variety.....	.10	.40	1.00	3.00
<b>Swiss Chard.</b> (See page 47.)				

**CABBAGE**

One ounce will produce 3000 plants.

For early use, sow in hotbeds in February or March. Transplant as soon as the ground can be worked, in rows 2 feet apart, and the plants 18 inches apart in the rows. For late or Winter use, sow the seed in May.

	Pkt.	½ oz.	Oz.	¼ lb.
<b>Marshall's Baby Head.</b> Small, round, solid heads; fine for forcing or early use .....	\$0.10	\$0.60	\$1.00	\$3.00
<b>Marshall's First Crop.</b> An ideal variety for private gardens, producing solid pointed heads earlier than any other variety .....	.25	.60	1.00	3.00
<b>Charleston Wakefield.</b> Large conical heads. The best second early variety.	.10	.60	1.00	3.00



Imperator Carrots

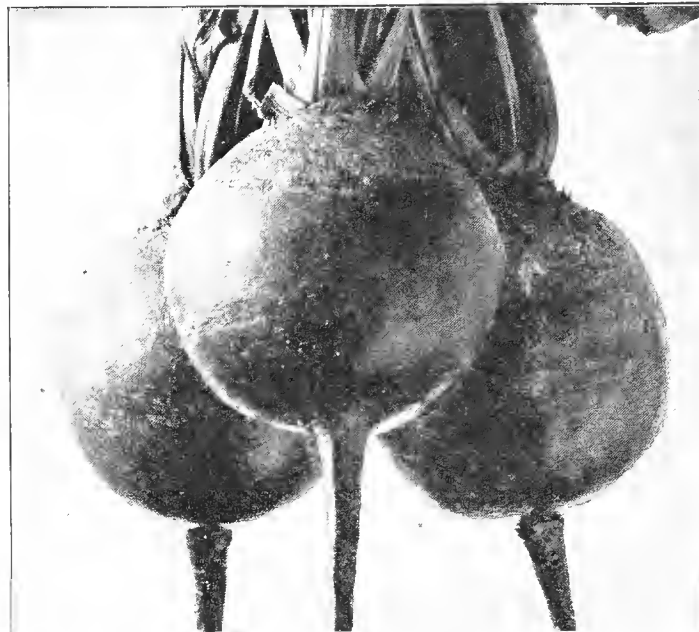

Perfected Detroit Beets

	Pkt.	½ oz.	Oz.	¼ lb.
<b>Chinese Chihili.</b> The earliest and most sure heading variety. Long, solid, white heads two feet in length.....	\$0.10	\$0.40	\$0.70	\$2.50
<b>Copenhagen Market.</b> Very early, round head; short stemmed.....	.10	.40	.70	2.50
<b>Danish Ball Head.</b> Very round; solid Winter sort. A fine shipper.....	.10	.40	.70	2.50
<b>Early Flat Dutch.</b> A second early Cabbage; large solid heads.....	.10	.40	.70	2.50
<b>Early Jersey Wakefield.</b> Standard early variety, conical shape; few outside leaves .....	.10	.40	.70	2.50
<b>Glory of Enkhuizen.</b> Heads large, round, very solid, midseason.....	.10	.40	.70	2.50
<b>Golden Acre.</b> An early round headed variety. Fine for home gardens.....	.10	.50	1.00	3.00
<b>Large Late Flat Dutch.</b> The heads are large and solid, with few outer leaves.	.10	.40	.70	2.50
<b>Succession.</b> A week later than Early Summer. Large, solid heads.....	.10	.50	1.00	3.00
<b>Savoy, Marshall's Exhibition.</b> Medium sized heads and matures early. The best variety for private use.....	.10	.40	.75	2.50
<b>Mammoth Rock Red.</b> The largest red Cabbage; color deep red.....	.10	.40	.75	2.50
<b>Red Stonehead.</b> Medium size, but very solid heads .....	.10	.40	.75	2.50

**CARDON**

**Large Solid.** Grows about 4 feet high; leaves nearly free from spines. Pkt., 10c; oz., 35c.

**CARROTS**

One ounce will sow 200 feet of row.

For early crops sow as soon as the ground can be worked, and for later crops from the beginning until the end of May, in rows 15 inches apart and ½ inch deep. Thin out the young plants to 5 inches.

	Pkt.	Oz.	¼ lb.	Lb.
<b>Early French Forcing.</b> Tender and fine, best for early crops and frames....	\$0.10	\$0.40	\$1.00	\$3.00
<b>Early Scarlet Horn.</b> Very thick roots; fine for frames.....	.10	.25	.70	2.00
<b>Chantenay Half Long Stump.</b> Style of Nantes, broader shoulder.....	.10	.30	.75	2.00
<b>Coreless.</b> Roots about 6 inches long, stump rooted, coreless and rich red-orange color .....	.10	.30	.75	2.00
<b>Danvers Half Long.</b> Good quality, large; and productive. A popular sort.....	.10	.25	.70	2.00
<b>Imperator.</b> The roots are 5 to 8 inches long, gradually tapering at the tip, deep orange color.....	.10	.25	.70	2.00
<b>Long Orange.</b> For garden and field crops this is the best variety.....	.10	.30	.75	2.00
<b>Long Red Surrey.</b> Long tapering, smooth skin, orange-red roots.....	.10	.30	1.00	3.00
<b>Marshall's Exhibition.</b> A superb intermediate variety; skin clear, bright red color .....	.10	.30	1.00	3.00
<b>Marshall's Intermediate.</b> Fine exhibition variety .....	.10	.30	1.00	3.00
<b>Oxheart (Guerande).</b> Very thick and short, very sweet.....	.10	.25	.70	2.00

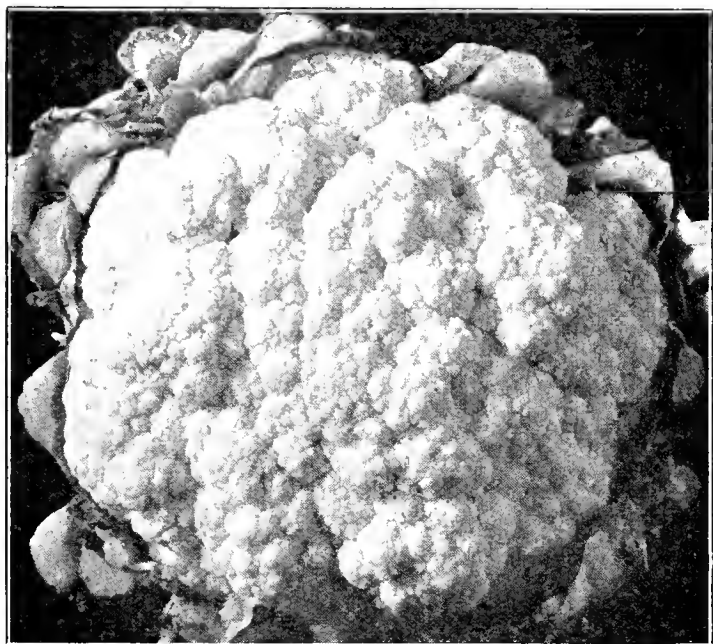

Snowball Cauliflower

**CAULIFLOWER**

One ounce of seed produces about 3000 plants.

By sowing the early varieties in a hotbed in February or March, or later in a cold frame, fine heads can be obtained quite early. When large enough transplant, making the rows about 2½ feet apart and 18 inches between the plants. Transplanting should be done in moist weather.

	Pkt.	¼ oz.	Oz.
<b>Marshall's First and Best.</b> The earliest and most solid heading variety grown. Large snow-white heads	\$.50	\$2.50	\$8.00
<b>Earliest Dwarf Erfurt.</b> The best and earliest for forcing under glass; very dwarf	.25	1.00	3.00
<b>Marshall's Extra Early Snowball.</b> One of the best for forcing or open ground	.25	1.00	3.00
<b>Dry Weather.</b> Especially adapted for long, dry seasons	.25	1.00	3.00
<b>Autumn Giant.</b> Large, vigorous grower and late	.20	.50	1.50
<b>Algiers.</b> An extra fine, late variety	.10	.50	1.50
<b>Market Garden.</b> A large variety of the Erfurt type, solid white heads. A popular late sort.	.10	.75	2.50

**CELERY**

One ounce will sow about 300 feet of row and produce about 5000 plants.

Sow in the open border early in April, in rich ground. When the plants are 3 inches high transplant 4 inches apart into temporary beds of soft, rich soil until they acquire sufficient strength for planting out. Plant in rows 3 feet apart and set 8 inches apart in the rows. About the middle of August earthing up is necessary for blanching and whitening of that which is wanted for early use.

	Pkt.	½ oz.	Oz.
<b>Easy Blanching.</b> Blanches very easily, medium dwarf, good flavor and a fine keeper	\$.15	\$0.60	\$1.00
<b>Emperor or Fordhook.</b> Dwarf, with large, light yellow heart; very crisp and good keeper	.15	.60	1.00
<b>Fin de Siecle.</b> The best keeping Winter Celery	.10	.35	.60
<b>Giant Pascal.</b> The stalks are solid and crisp; golden yellow heart	.10	.35	.60
<b>Golden Self-Blanching.</b> French grown; crisp, tender and of fine flavor	.25	.60	1.00
<b>Market Red.</b> Large and solid. Fine table variety	.10	.35	.60
<b>Marshall's Golden Plume.</b> Two to three weeks earlier than any other variety. Blanches easily, solid heart; sweet, crisp and tender	.25	1.50	3.00
<b>Marshall's White Plume.</b> A valuable early variety. Requires very little blanching	.10	.50	.75
<b>Newark Market.</b> A taller strain of Golden Self-blanching	.25	1.50	3.00
<b>Winter Queen or Schumacher.</b> Very large; solid green, winter variety; blanches well	.10	.50	.75

**CELERIAC**

or TURNIP-ROOTED CELERY

Grown mostly for its bulbous roots, which may be stored like Beets for Winter use.

	Pkt.	½ oz.	Oz.
<b>Giant Prague.</b> The finest variety. Very large roots which are almost round	\$.10	\$0.25	\$0.40

**CHERVIL**

The Curled Chervil is cultivated like Parsley and used for garnishing and flavoring soups and salads.

	Pkt.	Oz.	¼ lb.
<b>Curled Chervil.</b> The young leaves are used for flavoring soups and salads	\$.10	\$0.30	\$1.00

**CHICORY**

	Pkt.	Oz.	¼ lb.
<b>Italian Chicory.</b> Venetian red. Leaves red with yellow stripes	\$.10	\$0.30	\$1.00
<b>Large-Rooted Magdeburg.</b> Used to mix with or as a substitute for coffee	.10	.30	1.00
<b>Witloof, or French Endive.</b> The stalks when blanched are used for salad	.10	.50	1.50
<b>CHICORY ROOTS.</b> Strang far forcing. Doz., \$1.00; 100, \$7.00.			

**COLLARDS**

Sow seeds, as for Cabbage, in June, July and August, for succession. Transplant when a month old in rows a foot apart each way and hoe often.

**Georgia.** Cabbage greens used as a substitute for Cabbage. Pkt., 10c; oz., 20c; ¼ lb., 50c.

**CORN SALAD, OR FETTICUS**

One ounce will sow 150 feet of drill.

Sow in September in drills 8 inches apart, covering the seeds lightly, and protect from frost by light covering of hay and litter. The seed may be sown in spring.

**Large-Seeded.** The most popular variety grown. Pkt., 10c; oz., 20c; ¼ lb., 60c; lb., \$2.00.

**CRESS, OR PEPPERGRASS**

One ounce will sow 150 feet of drill.

A popular salad which should be sown early in the Spring very thickly in shallow drills and at short intervals for succession, as it soon runs to seed.

	Pkt.	Oz.	¼ lb.	Lb.
<b>Extra Curled.</b> The best variety grown; leaves are beautifully cut and curled; highly prized for garnishing	\$.10	\$0.20	\$0.50	\$1.50
<b>Upland, or Broad-leaved Winter.</b> A garden substitute for Water Cress; crisp, tender and perfectly hardy	.10	.20	.50	1.50
<b>True Water Cress.</b> Water Cress requires a stream of running water, ditch or pond, in which it will grow without care, except at first keeping weeds from interfering with it	.25	.75	2.50	



Marshall's Golden Plume Celery

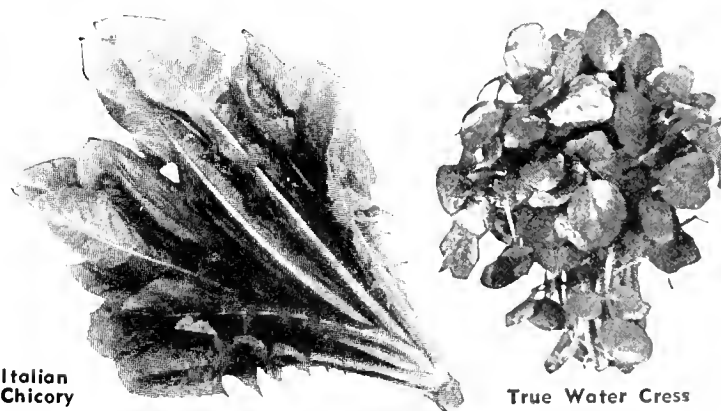

Italian Chicory

True Water Cress

# Corn, Sweet

Plant in hills 3 feet apart each way, dropping five or six kernels in each hill, or in rows 3 feet apart, and the plants thinned out 8 to 9 inches in the row. From May until the middle of July a succession planting can be made every two or three weeks, and a continued supply can be had until frost kills the plants.

## HYBRID CROSS CORNS

These varieties are Disease-resisting Sweet Corns that are practically immune from Bacterial Diseases.

	1/2 lb.	Lb.	2 lbs.	8 lbs.
<b>Golden Cross Bantam.</b> A disease-resisting variety. Ears larger than Golden Bantam .....	\$0.40	\$0.70	\$1.25	\$4.50
<b>Spancross C-2.</b> The earliest of the Hybrid varieties. The ears are 10- to 16-rowed and 6 to 9 inches long. Kernels very sweet .....	.40	.70	1.30	5.00
<b>Morcross 39.</b> The largest of the early hybrid varieties. Ears 7 1/2 inches long, 12- to 16-rowed with light yellow kernels of good quality .....	.40	.70	1.30	5.00
<b>Kingscross Golden Bantam.</b> A double cross between inbred strains. About 10 days earlier than Golden Bantam. A wonderful corn but is not adapted for Long Island or low altitudes....	.40	.70	1.30	5.00

## EXTRA EARLY

<b>Marshall's Early Golden Sugar.</b> The golden ears are six inches long, eight rowed, very sweet and 10 days earlier than Golden Bantam. Height only 4 feet. An excellent variety for the home garden .....	.30	.50	.90	3.25
<b>Midget.</b> A very dwarf variety with dark foliage. Height about 30 inches. Ears 3 to 4 inches long with sweet white kernels. Suitable for the small home garden or growing under glass. Pkt., 25c.				

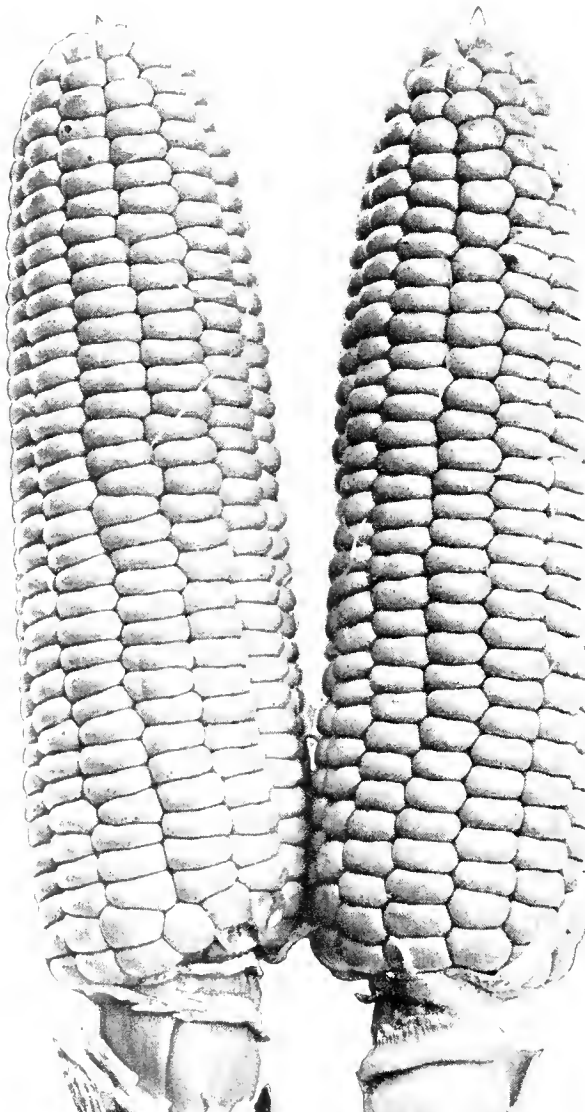

Morcross 39 Sweet Corn

	1/2 lb.	Lb.	2 lbs.	8 lbs.
<b>Golden Bantam.</b> Extra early; yellow, very sweet and tender.....	\$0.25	\$0.40	\$0.70	\$2.50
<b>Golden Giant.</b> A cross between Golden Bantam and Howling Mob. Medium growth. Ears 8 inches long.....	.20	.40	.75	2.50
<b>Golden Rod, or Bantam Evergreen.</b> Very early, golden grains and sweet flavor. ....	.20	.40	.70	2.50
<b>Golden Sunshine.</b> An improved Golden Bantam with 12 rows of luscious corn to each ear. Cobs measure 6 1/2 inches long. Earliest of the yellow corn..	.20	.40	.75	2.50
<b>Whipple's Early Yellow.</b> An early yellow variety. Ears about 7 inches long, eight-rowed; very fine flavor.....	.20	.40	.70	2.50
<b>Spanish Down.</b> A very early hybrid with large ears and 14 rows of sweet yellow kernels. Ears 6 to 8 inches long and matures seven days earlier than Golden Bantam .....	.30	.50	.95	3.50

## SECOND EARLY

<b>Early Evergreen.</b> Ripens about 10 days earlier than Stowell's Evergreen....	.20	.40	.70	2.25
<b>Metropolitan.</b> Large, handsome ears of fine quality .....	.20	.40	.70	2.25

## GENERAL AND LATE

<b>Black Mexican.</b> The sweetest and most delicious variety grown.....	.25	.40	.70	2.50
<b>Country Gentlemon.</b> Ears medium size; deep grains in irregular rows on cob and deliciously sweet.....	.25	.45	.80	2.75
<b>Golden Country Gentlemon or Golden Creom.</b> Ears the size of Golden Bantam but the grain is smaller of a rich golden color .....	.25	.40	.75	2.50
<b>Stowell's Evergreen.</b> The most popular variety grown; ears large and very sweet .....	.25	.45	.80	2.75

## CUCUMBERS

One ounce to 60 hills, 2 to 3 pounds to one acre.

For very early use seed may be started in heat and the plants set out in May. Pieces of inverted sod are an excellent medium for starting and growing early Cucumber plants as they can readily be lifted from the hotbed to the garden without disturbing the young plants growing upon them. For main crop plant in hills 4 feet apart at the end of May. Keep the young plants safe from the striped bug dusting with dry plaster or powdered Hellebore. Leave four strong plants to each hill.

	Pkt.	Oz.	1/4 lb.
<b>Cool and Crisp.</b> A strain of White Spine; flesh peculiarly crisp and tender .....	\$0.10	\$0.25	\$0.75
<b>Chinese Long.</b> The fruits are 12 to 15 inches long, bright green color and of best quality for slicing .....	.10	.50	1.50
<b>Dovis' Perfect.</b> An excellent variety both for outdoors and forcing purposes .....	.10	.25	.70
<b>Early Fortune.</b> Very dark green skin, flesh thick, seed cavity small and excellent quality; for table use or pickles .....	.10	.25	.75
<b>Fordhook Famous.</b> The largest and most handsome garden variety. The skin is a bright green .....	.10	.25	.75
<b>Green Prolific Pickling.</b> Dark green; medium strength; very free bearer .....	.10	.25	.70
<b>Improved Long Green.</b> Long and crisp; a popular variety for pickles .....	.10	.25	.70
<b>Improved White Spine.</b> Early and good for table use or pickling; of medium length; dark green color and flesh crisp and excellent....	.10	.25	.70
<b>Japanese Climbing.</b> This is a strong and vigorous grower; fine for pickling .....	.10	.25	.75
<b>Marshall's Longfellow.</b> Dark green color, 10 to 14 inches long. A good forcer .....	.10	.40	1.25
<b>West Indian Gherkin.</b> Used only for pickles; the smallest of all varieties .....	.10	.25	.75

## ENGLISH FORCING CUCUMBERS

<b>Covent Garden Favorite</b> .....	Pkt. \$0.50
<b>Lockie's Perfection</b> .....	.50
<b>Sutton's Everydoy</b> .....	.50
<b>Telegraph Improved</b> .....	.50



Giant Leek

**DANDELION**

The Dandelion affords one of the earliest and most healthful spring greens or salads.

**Improved French.** Large thick leaves. Pkt. 10c, oz. \$1.25, 1/4 lb. \$4.50.

**Italian, Cichoria Catalogna.** The leaves are more upright than the Dandelion. Pkt. 15c, oz. 60c.

**EGGPLANT**

One ounce will produce about 2000 plants.

The Eggplant will thrive well in good garden soil. The seed should be sown in hotbed or warm greenhouse in March or April, and when about an inch high put in 2-inch pots. Plant about June 1st, 2 1/2 feet apart. If no hotbed is at hand they can be grown in any light room where the temperature will average 75 degrees.

	Pkt.	1/2 oz.	Oz.
<b>Black Beauty.</b> As large as New York Improved but 10 days earlier .....	\$0.10	\$0.40	\$0.80
<b>Long Purple.</b> Fruit longer and smaller than the above sort; hardy, productive.....	.10	.40	.75
<b>New York Improved.</b> Purple; the best variety; very large, oval, heavy fruit .....	.10	.40	.75

**ENDIVE**

One ounce of seed for 100 feet of drill.

One of our best salad plants. For a first crop sow about the middle of April; for succession small sowings may be made every month till August, when the main planting is made. Set out the plants 1 foot apart in rows and when well grown blanch by folding the leaves.

	Pkt.	Oz.	1/4 lb.
<b>Broad-leaved (Escarolle).</b> Leaves long and broad; thick and succulent .....	\$0.10	\$0.30	\$0.75
<b>Full Heart Batavian.</b> An improved broad leaved variety. Full compact hearts .....	.10	.30	.75
<b>Green Curled.</b> Hardy, finely curled; easily blanched. One of the best .....	.10	.30	.75
<b>White Curled.</b> Blanches rapidly; excellent and very tender .....	.10	.30	.75

**HORSERADISH SETS**

If planted in early spring, roots of good size may be had by midsummer. Plant the roots in well fertilized soil about one foot apart and three inches deep. If space is a consideration, they may be planted between rows of other low growing crops.

**New Bohemian.** A new variety which produces roots of enormous size and succeeds in every soil. Doz. 50c, 100 \$2.00.

**KALE, OR BORECOLE**

One ounce will sow 150 feet of drill

Sow about the middle of April in prepared beds, covering thinly and evenly; plant out in June following the directions recommended for cultivating Cabbage.

	Pkt.	Oz.	1/4 lb.
<b>Curled Dwarf Green Scotch.</b> Very dwarf and spreading; best strain .....	\$0.10	\$0.30	\$1.00
<b>Marshall's Exhibition Curled.</b> Closely curled leaves .....	.10	.60	2.00
<b>Curled Siberian Improved.</b> Uniformly dwarf; green curled; hardy .....	.10	.30	1.00

**KOHL-RABI**

One ounce will sow 300 feet of row.

This delicious vegetable should be in every vegetable garden. It forms a bulb at the base of the stem above the ground. Successive sowings should be made throughout the season and good cultivation is necessary. Use the bulbs of Kohl-rabi when they are about the size of an apple as they become hard and stringy if grown too long.

	Pkt.	1/2 oz.	Oz.	1/4 lb.
<b>Early White Vienna.</b> Very early and should be used before being fully grown. Flesh white with greenish white skin .....	\$0.10	\$0.25	\$0.50	\$1.50
<b>Early Purple Vienna.</b> Similar to the preceding, except in color .....	.10	.25	.40	1.25

**LEEK**

One ounce will sow 200 feet of drill.

The Leek is very hardy and easily cultivated; it succeeds best in light but well enriched soil. Sow as early in the spring as practicable, in drills 1 inch deep and 1 foot apart. When 6 to 8 inches high transplant in rows 10 inches apart each way, as deep as possible, that the neck, being covered, may be blanched.

	Pkt.	Oz.	1/4 lb.
<b>Marshall's Giant.</b> The largest and best Leek for exhibition. Highly recommended as the choicest variety in cultivation of a mild and delicious flavor .....	\$0.10	\$0.80	\$2.50
<b>Large American Flag.</b> The most desirable for market or family use.....	.10	.30	1.00
<b>Musselburgh, or Carentan.</b> A very large variety of superior quality .....	.10	.30	1.00

**FREE DELIVERY.** We deliver vegetable and flower seeds when cash accompanies your order.



Full Heart Batavian Endive

# Lettuce

One ounce will sow 200 feet of drill.

Sow in the open ground as early as possible, barely covering the seed. If the hotbed is used let it be started quite early. Give but little heat and plenty of water and air on fine days. Let plants in the beds be about 4 inches apart. As they increase in size thin them out or they will become weak. Plant for late use in a cool, portially shaded place in rich soil.

### CURLED, or LOOSE-LEAVED VARIETIES

	Pkt.	Oz.	¼ lb.
<b>Early Curled Simpson.</b> One of the earliest and best for market .....	\$0.10	\$0.30	\$1.00
<b>Grand Rapids.</b> This is regarded as the best forcing loose-leaved variety .....	.10	.30	1.00

### CABBAGE, or HEADING VARIETIES

<b>All Seasons.</b> Large, handsome, extremely solid head; color a light grayish green .....	.10	.30	1.00
<b>Big Boston.</b> Fine for forcing in cold frames or for open ground .....	.10	.30	1.00
<b>Crisp as Ice.</b> Medium size, compact head, outer leaves tinged dark brown .....	.10	.35	1.00
<b>Deacon.</b> A splendid variety for standing the summer heat; large, solid head .....	.10	.30	1.00
<b>Giant Crystal Head, or Iceberg.</b> Large, solid outside leaves bright green, inside white....	.10	.30	1.00
<b>Golden Queen.</b> A good forcing variety of a golden yellow color; heads solid.....	.10	.50	1.50
<b>Hanson Improved.</b> Heads large, hearts quickly and stands the summer well .....	.10	.35	1.00
<b>Marshall's Royal Summer.</b> A large butter head, with thick leaves, dark green tinged and spotted brown. The inside of head is a rich yellow .....	.10	.60	2.00

**Marshall's Matchless.** This lettuce is now conceded by connoisseurs to be the finest lettuce introduced in many years. It is a cross between a head variety and the Cos type. It forms a loose leaved head and its delicacy and flavor put it in a class of its own. If you have room for only one kind of lettuce we strongly recommend our Matchless. Per pkt. 25c, per oz. \$1.00.

	Pkt.	Oz.	¼ lb.
<b>May King.</b> Extra large, solid heads; light green outside, with clear yellow heart; very tender and of fine flavor; splendid forcer.....	\$0.10	\$0.30	\$1.00
<b>Mignonette.</b> Distinct russet colored; very solid and compact .....	.10	.35	1.00
<b>New York, or Wonderful.</b> Large, solid heads; inside very white .....	.10	.40	1.00
<b>Tennis Ball.</b> (Black-Seeded or Salamander). A very distinct head with few outer leaves....	.10	.30	1.00
<b>Wheeler's Tom Thumb.</b> A splendid forcing variety .....	.10	.75	2.00
<b>White Boston.</b> Similar to Big Boston, differing in being a lighter green without the brownish tinge on the borders .....	.10	.35	1.00

### ROMAINE, or COS VARIETIES

These are distinct from the ordinary Lettuce, and much liked on account of their crisp, tender quality. They produce long, narrow leaves, blanched by drawing in the outer leaves and tying.

	Pkt.	Oz.	¼ lb.
<b>Eclipse Cos.</b> A perfectly distinct variety. It is the dwarfest Cos Lettuce .....	\$0.10	\$0.60	\$2.00
<b>Paris White, or Trianon Cos, Romaine.</b> One of the finest varieties for summer use.....	.10	.35	1.00



Marshall's Matchless Lettuce

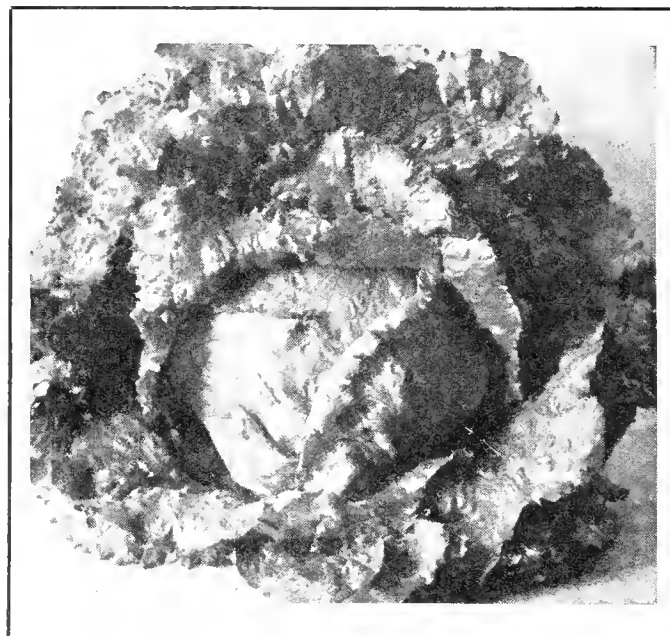

New York or Wonderful Lettuce

## MUSHROOM SPAWN

Ten pounds will spawn about 10 feet square.

Mushroom beds may be made in a warm, dry cellar, or in any building where the frost does not penetrate and in the open air during the summer and fall months. Having procured the spawn, the next thing to be attended to is to make preparation for the beds. About two or three weeks before the beds are to be made collect a quantity of fresh horse manure without the straw; place it in a heap under cover, and as it heats keep turning it over once or twice a week, until the fiery heat has become exhausted, which will require from ten to fourteen days' time. When the manure is in a condition to be made up lay out your bed, according to your requirements, say 3 feet wide, 10 feet long and from 2 to 3 feet deep; beat it down well with the back of the spade as the process of building goes on. When the bed has been made some time, say a week or thereabouts, and the heat sufficiently declined to a temperature of 65 or 75 degrees, the spawn may be put into it. Break the spawn in pieces 2 inches square, and put them 6 inches apart, all over the bed; then cover the bed with 2 inches of rich soil. If everything goes well, you may expect Mushrooms in about five or six weeks. When the soil looks dry give a gentle watering with tepid water, using a rose on the watering pot. Good crops of Mushrooms can be obtained by spawning the hotbeds in spring.

**Pure Culture Prolific Direct Bricks.** An American-made spawn which produces large crops of large size, deep cream and excellent quality Mushrooms. Per brick 45c, 10 bricks for \$3.50, 50 bricks \$15.00.

**Bottle Spawn.** This spawn is very perishable and can only be kept in cold storage. Orders filled from the factory. One quart will spawn 50 sq. ft. Per quart bottle \$1.25, 12 quarts for \$12.00.

**FREE DELIVERY.** We deliver vegetable and flower seeds when cash accomponies your order.

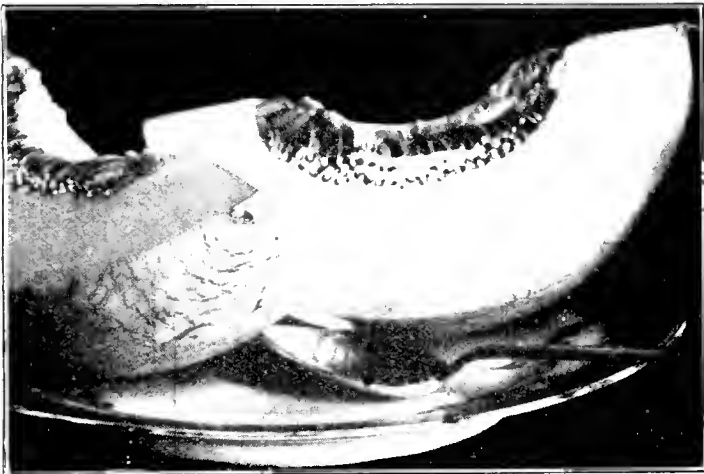

Honey Ball Muskmelon

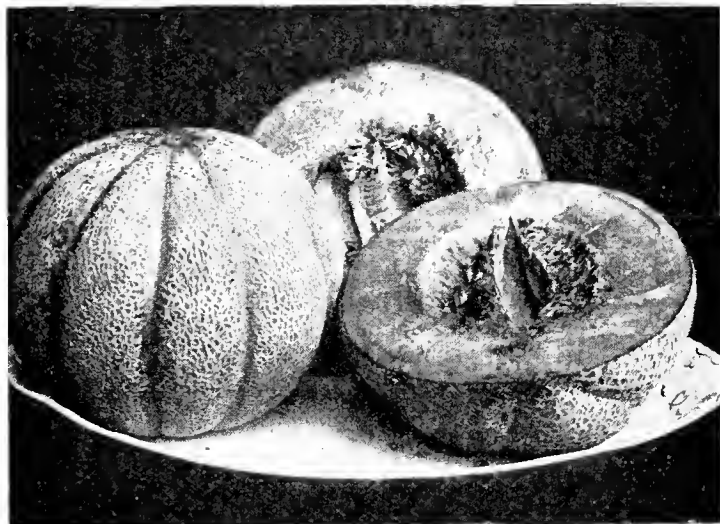

Harute Muskmelon

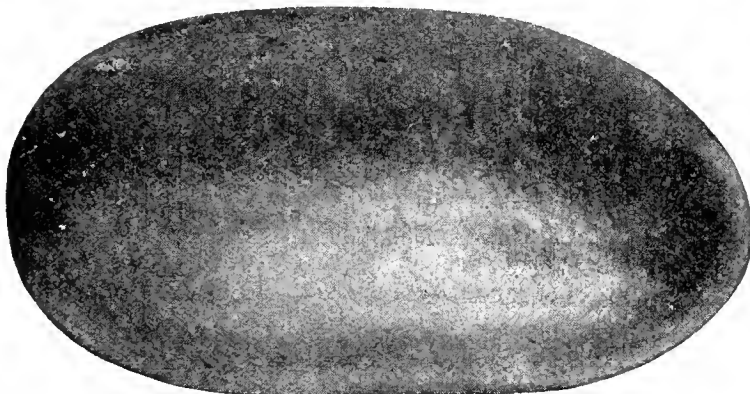

Tom Watson Watermelon

**MUSTARD**

One ounce will sow 100 feet of drill.

For early crops the seed may be sown in a hotbed in March, and for general crop at frequent intervals through the spring, in drills from 8 to 12 inches apart.

	Pkt.	Oz.	1/4 lb.	Lb.
<b>White London.</b> The best variety for salad	\$0.10	\$0.20	\$0.40	\$1.25
<b>Giant Southern.</b> Curled. Very large leaves	.10	.20	.40	1.25
<b>Fordhook Fancy.</b> A mild variety, used for salads or cooked as Spinach. Leaves dark green	.10	.25	.75	2.00

**OKRA, OR GUMBO**

This plant is extensively cultivated for its green pods, which are used in soups and stews, and are very wholesome and nutritious. Sow about the middle of May in drills 3 feet apart and thin out the plants to 1 foot apart.

	Pkt.	Oz.	1/4 lb.	Lb.
<b>Dwarf Green.</b> Very early; smooth pods	\$0.10	\$0.20	\$0.40	\$1.00
<b>Perkins' Long Green.</b> Long ribbed pods; very productive	.10	.20	.40	1.00
<b>White Velvet.</b> Tender white pods; smooth and velvety in appearance	.10	.20	.50	1.25

**MELON, MUSK**

An ounce will plant 60 hills.

After all danger of frost is over and the ground has become warm and dry, plant in hills 4 to 6 feet apart each way, 6 to 12 seeds to a hill. When up and all danger of insects has passed, pull out all but three plants. Cultivate until the vines cover the ground.

	Pkt.	Oz.	1/4 lb.
<b>Bender's Surprise.</b> A very delicious, large salmon fleshed Melon. Shape oblong and rounded at the ends	\$0.10	\$0.40	\$1.25
<b>Emerald Gem.</b> Small, early; dark green skin, orange flesh; very sweet	.10	.30	1.00
<b>Fordhook.</b> The flesh is very thick, of a deep salmon color	.10	.30	1.00

<b>Harute.</b> An outstanding Melon which we recommend very highly. Solid firm flesh and of a pale yellow when ripe. The flavor is superb. A luscious fruit which should be better known	.25	.75	2.50
--	-----	-----	------

<b>Hearts of Gold.</b> Medium size, flesh rich deep orange-scarlet and very sweet	.10	.30	1.00
<b>Holmes' Supreme.</b> A large variety; flesh orange-scarlet; outside deep green; delicious flavor	.25		2.00
<b>Honey Ball.</b> Excellent for the home garden. Fruits round, yellowish white, flesh grey-green and very sweet	.10	.30	1.00
<b>Honey Dew.</b> Large, round to oval in shape, skin smooth, hard and nearly white, flesh light green. Excellent flavor	.10	.40	1.25
<b>Marshall's Matchless.</b> A very large, distinctively ribbed and netted variety. The flesh is orange-scarlet color, very thick and of a luscious flavor. Seed cavity very small	.25		2.00
<b>Milwaukee Market.</b> Very attractive and delicious flavor. Color light green with salmon flesh	.10	.30	1.00
<b>Osage, or Miller's Cream.</b> A large oval, orange-salmon flesh Melon of superior quality	.10	.30	1.00

Melons started under "Hotkaps" or Melon Frames may be planted much earlier.

**ENGLISH FORCING MELONS**

The English Melons are used for growing in Greenhouses or Frames and are not adapted for outside planting.

	Per Pkt.
<b>Blenheim Orange.</b> Handsome scarlet flesh, superb flavor	\$0.50
<b>Cotting's Hybrid.</b> Oval shape, attractive orange flesh, and its green skin changes to orange when ripe. Delicious flavor and fine cropper	1.00
<b>Superlative.</b> Flavor exceptionally fine, scarlet flesh, round fruits, very productive	.50

**MELON, WATER**

One ounce will plant about 30 hills.

Plant in hills as directed for Muskmelons, and treat in all respects the same, except that the hills should be 8 to 10 feet apart.

	Pkt.	Oz.	1/4 lb.
<b>Citron.</b> Round and handsome, for preserving; red seed	\$0.10	\$0.20	\$0.50
<b>Cole's Early.</b> Medium size; red flesh; green skin	.10	.20	.50
<b>Fordhook, Early.</b> Flesh bright red; very sweet	.10	.25	.60
<b>Kleckley Sweets.</b> Exceedingly sweet and fine flavored	.10	.25	.60
<b>Mountain Sweet.</b> Early, large, oblong, skin dark green, flesh red and sweet. A good variety for northern gardens	.10	.20	.50
<b>Stone Mountain.</b> A very large, nearly round Melon of high quality. Dark green rind, flesh deep scarlet and very sweet. A fine home garden variety	.10	.25	.60
<b>Tom Watson.</b> Dark green rind with deep red flesh, very large, oblong shape	.10	.25	.60

Mushroom Spawn (See Page 42).

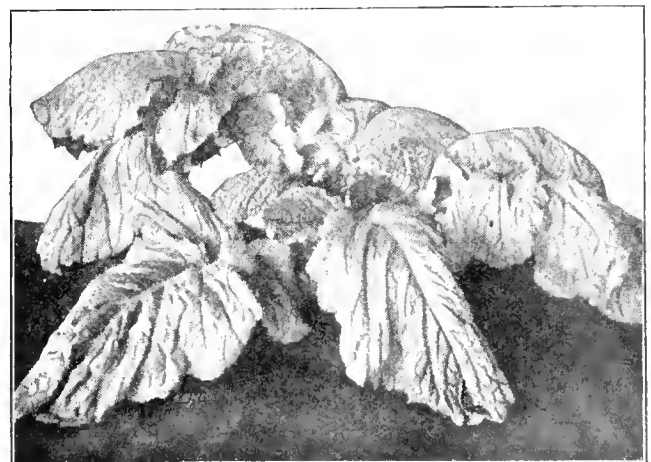

Giant Southern Mustard

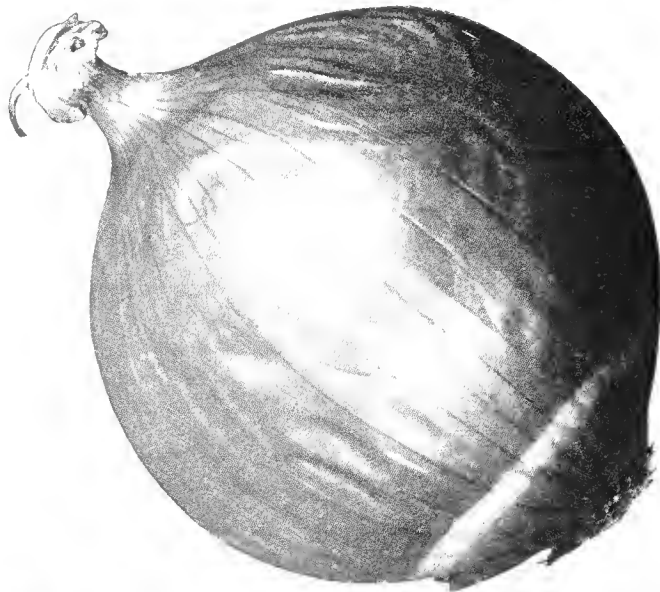

White  
Globe  
Onion

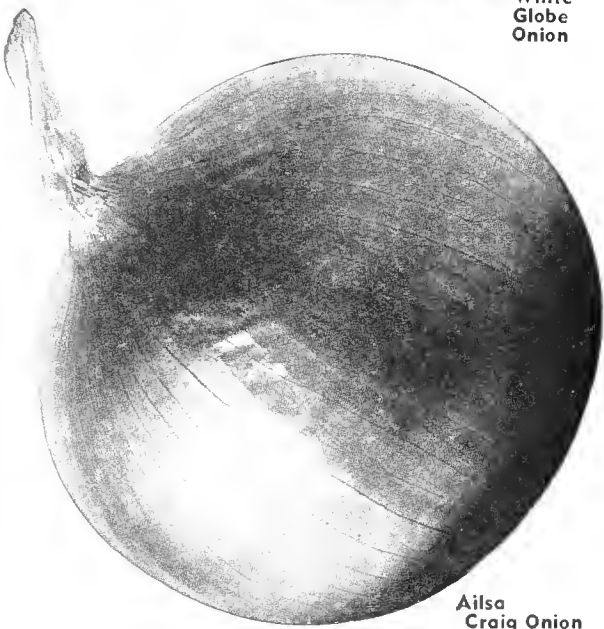

Ailsa  
Craig  
Onion

**ONION SETS**

Three quarts will plant 100 yards of row.

Onion Sets should be planted early in the spring in rows 12 inches apart, placing the sets 4 inches apart in the row. When raised from sets the Onions can be used in the green state in June, or they will be matured by July.

	Lb.	5 lbs.	10 lbs.
Red Onion Sets	\$0.40	\$1.75	\$3.25
White Onion Sets	.50	2.25	4.00
Yellow Ebenezer Onion Sets	.40	1.75	3.25
White Multipliers	.50	2.00	3.50
Shallots	.60	3.00	5.00
Garlic	.60		

Prices of Onion Sets are subject to market changes.

**PARSLEY**

One ounce will sow 200 feet of row.

Sow as early as possible in spring, first soaking the seed three hours in water; cover lightly, raking the soil fine and level on top. The drills should be about 15 inches apart. The plants appear in two to four weeks. Thin to 3 inches apart.

	Pkt.	Oz.	¼ lb
Marshall's Crested Gem. A very dwarf, compact variety. Intensely curled and very dark green. Best for edging and home garden....	\$0.10	\$0.50	\$1.50
Marshall's Dwarf Perfection. A dwarf and compact Parsley of bright green color, exquisitely curled	.10	.35	1.00
Extra Double, or Moss Curled. A beautiful curled dwarf variety	.10	.20	.50
Paramount. An unusually dark green color, triple curled with a uniform plant type....	.15	.25	.75
Turnip Rooted. Grown for its roots which are used in flavoring soups	.10	.20	.50
Plain. A plain-leaved variety; fine for flavoring	.10	.20	.50

**Onions**

One ounce will sow 200 feet of drill. 4 to 5 pounds to the acre. Sow in drills 1 foot apart and cover about one-third of an inch, treading or rolling after sowing so that the hot, dry atmosphere may not destroy the sprouting seed. When 3 inches high thin to 2 inches apart. Stir the ground freely without disturbing the young plants and keep free from weeds.

For thrips on the foliage spray with Red Arrow or dust with To-Na-Cide.

**RED VARIETIES**

	Pkt.	½ oz.	Oz.	¼ lb.
Large Red Wethersfield. A good sized onion of purplish red color. Splendid keeping qualities and very productive	\$0.10	\$0.25	\$0.40	\$1.00
Large Red Globe. (Southport Strain). Considered the finest type of red onion. Globe shaped, of a deep red-purple color and its keeping qualities make it extremely popular	.10	.25	.50	1.50

**WHITE VARIETIES**

Early White Barletta. A small White Italian variety much in demand for pickling. Matures early, flesh mildly flavored	.10	.25	.50	1.50
Large White Portugal. For general use we recommend this popular variety. Its mild aromatic flavor and appetizing appearance appeal to all vegetarians. Flat shaped	.10	.30	.50	1.50
Marshall's Large White Globe. (Southport Strain). Here we offer what we consider the best white globe onion obtainable. For appearance, flavor and all around qualities this is unsurpassed	.10	.35	.65	2.00
White Bermuda. A very early flat variety which has maintained its popularity. Fine flavor	.10	.25	.50	1.50
White Tripoli. Large flat white Italian variety of great productivity and good flavor	.10	.30	.60	2.00

**YELLOW VARIETIES**

Marshall's Ailsa Craig. One of the finest varieties for exhibition and general use. Oval shape with pale straw colored skin. Good cultivation will reward the grower with extra large specimens..	.25	.40	.75	2.50
Danvers Yellow. A round, flat, standard sort; early and a good keeper	.10	.30	.50	1.50
Marshall's Giant Gibraltar. A superb, but little known, variety suitable for exhibition purposes. Mild flavor. A general favorite	.25	.50	1.00	3.00
Marshall's Invincible Giant. Acknowledged by experts to be outstanding in quality and when well grown reaches an immense size of fine form and with pale yellow skin. Good keeping qualities	.25	1.00	2.00	
Yellow Globe Danvers. (Southport Strain). Of more globular shape; keeps well	.10	.25	.50	1.50
Yellow Prizetaker. Immense size; globe-shaped, pale yellow	.10	.30	.50	1.50

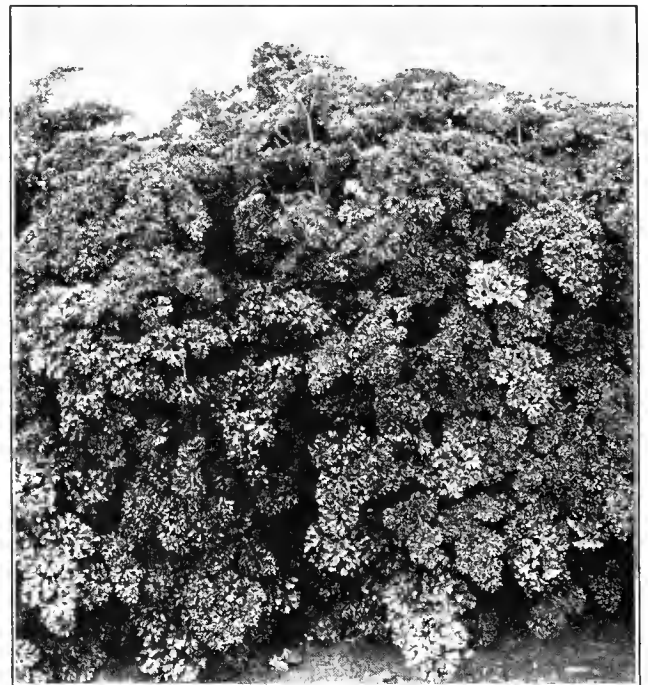

Marshall's Dwarf Perfection Parsley



**PARSNIP**

One ounce will sow 200 feet of drill

Sow Parsnip seed as early in the spring as the weather will permit, in drills from 15 to 18 inches apart, covering with fine soil to the depth of half an inch. The soil should be rich and deep; manured if possible, the previous autumn. Thin out the young plants to about 6 inches apart and keep the surface of the ground open and free from weeds. It is perfectly hardy and may remain in the ground through the winter. Indeed, the fine sugary flavor is only perfected by a severe frost.

	Pkt.	Oz.	¼ lb.	Lb.
<b>Marshall's Marrow.</b> A grand selection, clean white, long roots; fine for exhibition and family use. The finest stock in this country	\$0.10	\$0.30	\$1.00	\$3.00
<b>American Hollow Crown.</b> Long, smooth and milky white	.10	.25	.60	1.50

**Peas**

One quart will plant about 150 feet of drill.

Peas mature earliest in a light, rich soil; for general crop a rich loam is the best. When grown in gardens sow in double rows 6 to 8 inches apart, the rows 2 to 4 feet apart, the tall ones requiring brush. Commence sowing the extra early varieties as early as the ground can be worked in February or March and continue for a succession every two weeks until July.

**EXTRA EARLY PEAS**

	Height in ft.	½ lb.	Lb.	2 lbs.	8 lbs.
<b>Alaska.</b> One of the very earliest blue Peas; quite productive	2½	\$0.25	\$0.40	\$0.75	\$2.50
<b>Blue Bantam.</b> A fine extra early wrinkled Pea. Large pods well filled with deep green, fine flavored Peas	1½	.25	.40	.80	3.00
<b>Extra Early Market, Marshall's.</b> A standard extra early Pea; productive and profitable to grow	2½	.25	.40	.80	2.75
<b>Early Bird.</b> A very early, round seeded, fine flavored variety. Pods 4 inches long and well filled. Very scarce	4	.30	.50	1.00	3.50
<b>Marshall's Little Giant.</b> An excellent, extra dwarf variety of highest quality. Pods with 6 to 8 large dark green peas	1½	.25	.40	.75	2.50
<b>Gradus, or Prosperity.</b> The finest extra early Pea. The pods are very large and well filled, with large wrinkled green Peas	3	.25	.45	.80	3.00
<b>Laxtonian.</b> Very large, dark green, curved pods and Peas of finest flavor	1½	.25	.45	.80	3.00
<b>Laxton's Progress.</b> An English wrinkled variety. A great bearer	2	.30	.50	.90	3.25
<b>Little Marvel.</b> Very early, wrinkled Peas, long pods	2	.25	.45	.80	3.00
<b>Sutton's Excelsior.</b> An extra early dwarf wrinkled Pea; pods filled with large Peas of the finest flavor	1	.25	.45	.80	2.75
<b>Thomas Laxton.</b> Very productive The pods are large and contain seven or eight large wrinkled Peas of the finest flavor	3	.25	.45	.80	3.00



**MEDIUM CROP PEAS**

	Height in ft.	½ lb.	Lb.	2 lbs.	8 lbs.
<b>Admiral Beatty.</b> An excellent medium early variety, wonderful bearer of large pods containing 8 to 10 Peas	4	\$0.30	\$0.50	\$0.90	\$3.25
<b>Champion of England.</b> Well known standard variety. Sow thickly	4	.25	.45	.80	2.75
<b>Duke of Albany</b> (American Champion). Immense pods	4	.25	.45	.80	3.00
<b>Onward.</b> Decidedly the best Pea of recent introduction. Pods are 4 inches long with 6 to 8 deep green sweet Peas. About a week earlier than Telephone	3	.25	.45	.80	2.75
<b>Perfect.</b> An English midseason variety, with handsome long pods produced in pairs, very heavy bearer	2½	.25	.50	1.00	3.50

**MAIN CROP PEAS**

<b>Alderman, or Prince Edward.</b> One of the finest of the large podded main crop varieties. Pods measure nearly 6 inches, well filled	4	.25	.40	.80	3.00
<b>Quite Content.</b> A giant podded variety; very prolific	5	.25	.45	.80	3.00
<b>Telephone.</b> A tall growing late sort, having pods of very large size, containing six or seven Peas of delicious flavor	4	.25	.40	.80	3.00
<b>The President.</b> A very productive variety, with dark green straight pods. 4½ inches long	1¾	.25	.40	.80	3.00

**SUGAR PEAS (Edible Pods)**

In Sugar Peas the pods are gathered, broken and cooked like string beans when the Peas start to develop in the pod or have reached about half their full size.

	Height in ft.	½ lb.	Lb.	2 lbs.	8 lbs.
<b>Gray-Seeded Sugar.</b> Large edible pods	3	\$0.20	\$0.35	\$0.70	\$2.50
<b>Tall, Melting Sugar.</b> One of the best edible pod sorts	5	.20	.40	.80	2.75
<b>Sugarstick.</b> (See novelties page 35)	4	.75	1.30	2.50	



Extra Early Market Peas

**PEPPER**

One ounce will produce 2000 plants.

Sow in hotbeds in March, and when the soil has become warm, set in rows 2 feet apart and 18 inches in the rows; hoe frequently. Plants may also be forwarded in small pots.

	Pkt.	½ oz.	Oz.
<b>Cayenne, Long Red.</b> Bright red, slender pods; 3 inches long	\$0.10	\$0.40	\$0.75
<b>California Wonder.</b> A large variety with very thick, mild, sweet flesh, color brilliant glossy crimson. Fruit four lobed about 4 inches long	.15	.50	1.00
<b>Chinese Giant.</b> Very large, bright scarlet	.10	.40	.75
<b>Large Bell or Bull Nose.</b> Large, bright red, largely used for pickling, mild flavor	.10	.40	.75
<b>Mammoth Golden Dawn.</b> An early, sweet, mild, yellow pepper	.10	.40	.75
<b>Marshall's Earliest.</b> Fruits mild and sweet, similar to Bull Nose. Plant dwarf, compact, and very productive. The earliest variety grown	.15	.50	1.00
<b>Marshall's Early Giant.</b> A very early large variety, dwarf compact growth; scarlet fruit 5 inches long, three lobed, mild and sweet	.15	.75	1.50
<b>Pepper-Tomato.</b> A cross between a Pepper and a Tomato. Scarlet oval shaped fruit	.25		
<b>Ruby King.</b> Bright red, 4 to 6 inches long; best for stuffing	.10	.40	.75
<b>Sweet Mountain.</b> Large size, regular handsome shape, mild flavor	.10	.40	.75
<b>World Beater or Ruby Giant.</b> Fruits large in size and very mild. A good home garden variety.	.15	.40	.75



World Beater or Ruby Giant Pepper

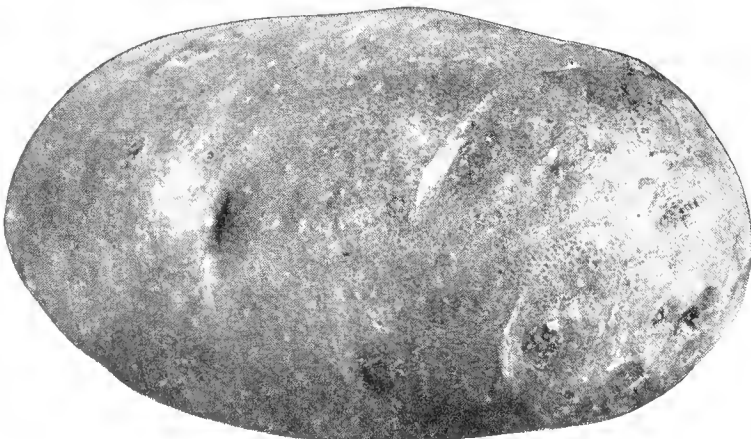

Dibble's Russet Potato

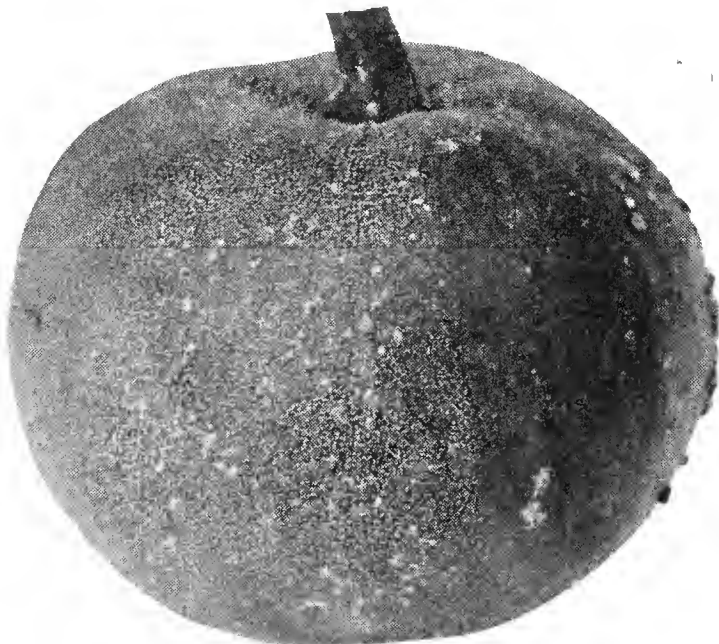

Winter Luxury Pumpkin

**POTATOES**

GROWN EXPRESSLY FOR SEED IN MAINE OR PRINCE EDWARD ISLAND

Peck will plant 100 foot row. Ten bushels cut tubers will plant 1 acre.

The Potato can be grown with varying success on soils of all kinds and in all conditions of fertility, but the soil best suited to it is a sandy loam. Manure is applied either in rows or hills or broadcast over the hills and ploughed in. In highly enriched soils the plants are more liable to disease than when grown in soil that is naturally good. Plant as early in spring as the ground can be had in fair working order, in hills or ridges, about 3 feet apart, cover lightly with soil about 4 inches deep.

**Beauty of Hebron.** Slightly flesh colored skin with pure white flesh; very productive and of the finest quality.

**Bovee.** Extra early; fine quality; flesh white.

**Dibble's Russet.** This is the best main crop Potato in cultivation. The tubers are round to oblong in shape, of good size, with white flesh and covered with russet skin. The quality when cooked cannot be excelled. It also has great disease-resistant and blight-proof properties.

**Early Rose or Spaulding Rose.** Very early; fine quality; very productive, skin shaded rose color.

**Green Mountain.** Oval shape; white skin and flesh; heavy yielder and good for winter use.

**Irish Cobbler.** One of the best extra early varieties.

At the time of going to press with this catalogue the Potato market is so unsettled that prices are subject to change.

Any of the above varieties. Bu. \$3.00, bog of 150 lbs. \$6.50.

Certified Stock of Green Mountain and Irish Cobbler. Bu. \$3.25, bag of 150 lbs. \$7.00.

Potatoes are forwarded by express or freight as directed, paying charges.

Weights—Bushel, 60 lbs.; Bag, 2½ bushels, 150 lbs.

**SWEET POTATO PLANTS**

**Red or Yellow Variety.** Plants ready end of May. Per 100 \$1.00, 1,000 \$7.00.

**PUMPKIN**

One ounce will plant 50 hills

The common practice is to drop two or three seeds in every second or third hill in the Cornfield, but if cultivated on a large scale the seed may be sown in hills 8 feet apart each way, four plants to each hill, and otherwise treated in the same manner as Melons or Cucumbers.

	Pkt.	Oz.	¼ lb.	Lb.
<b>Connecticut Field.</b> Grown in Cornfields for stock	\$0.10	\$0.20	\$0.50	\$1.50
<b>Early Sugar.</b> Fine grained; small; yellow	.10	.25	.60	2.00
<b>Large Cheese.</b> Flat; the best variety for small family use	.10	.25	.60	2.00
<b>Mammoth King.</b> Grows to an enormous size	.10	.30	.75	2.00
<b>Winter Luxury.</b> Round, medium in size, yellow netted skin, good keeper	.10	.30	.75	2.50



Sparkler Radish

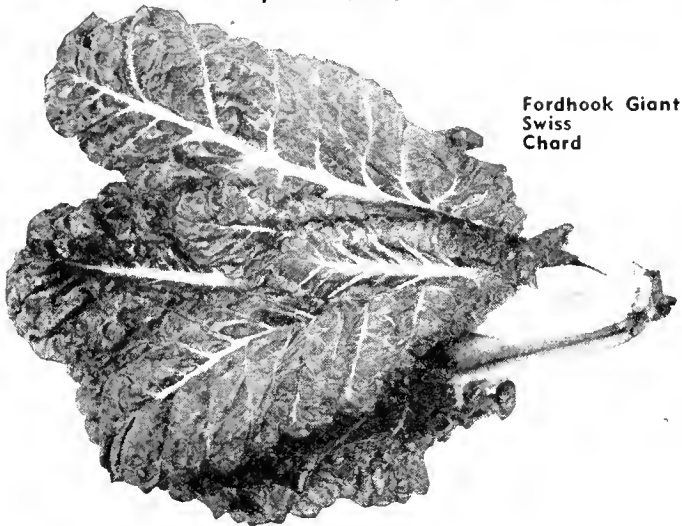

Fordhook Giant Swiss Chard

**SALSIFY, OR OYSTER PLANT**

One ounce will sow 150 feet.

A most delicious vegetable. It is used stewed, boiled, or fried, and sometimes as a salad. When cooked it has an oyster flavor. Sow seed from April to May in drills 18 inches apart. Cultivate the same as for Carrots or Parsnips.

	Pkt.	Oz.	¼ lb.	Lb.
<b>Mommoth Sandwich Island.</b> True. Large and superior; very fine flavor .....	\$0.10	\$0.35	\$1.00	
<b>Long Black, or Scorzonera.</b> Resembles long white, but black in color .....	.15	.60	1.50	

**SORREL**

One ounce will sow 150 feet of drill.

Used cooked as Spinach or to mix with salads. Sow in shallow drills 12 inches apart, and thin out the young plants to 6 inches.

**Large-Leaved French.** Pkt. 10c, oz. 25c, ¼ lb. 75c, lb. \$2.50.

**SWISS CHARD**

This beet produces leaves only; excellent as greens. Cultivate the same as Spinach, sowing the seed in early spring, in drills 1½ feet apart. Good cultivation will increase the delicacy and tenderness of the leaves.

	Pkt.	Oz.	¼ lb.	Lb.
<b>Swiss Chard.</b> The old standard variety, green leaves with white stalks. ....	\$0.10	\$0.25	\$0.60	\$1.50
<b>Fordhook Giant.</b> The leaves are much savoyed, of thick and fleshy texture, of rich blue-green color. The stalks are pearly white. ....	.10	.25	.60	1.75

**RHUBARB**

One ounce will produce 1000 plants.

Sow in drills 18 inches apart. When the plants are strong enough, thin out to 6 inches. In the fall or following spring, transplant the roots into deep, rich soil, 3 feet apart each way.

**Victorio.** Very large; later than the Linnaeus. Pkt. 10c, oz. 35c, ¼ lb. \$1.00, lb. \$3.00.

**Victorio Rhubarb Roots.** Extra strong. Each 30c, doz. \$3.50, 100 \$25.00.

**RUCOLA, OR ROCKET**

A salad with leaves resembling Sorrel. Cultivate same as Spinach. **Rucola roquette.** Useful for soups and salads. Pkt. 10c, oz. 45c, ¼ lb. \$1.50.

**RADISH**

One ounce of seed will sow 150 feet of drill.

Radishes require a light, loamy soil, moderately fertile, which should be deeply dug and well pulverized. The situation should be warm and sheltered. For an early supply sow in January or February in hotbeds, keeping well ventilated. In May they may be sown out-of-doors. Successive sowings should be made every two weeks. Radishes to be crisp and tender should make a rapid growth. Winter varieties should be sown in July and August.

**VARIETIES FOR FORCING OR OUTDOORS**

	Pkt.	Oz.	¼ lb.	Lb.
<b>Early Scarlet Turnip Forcing.</b> Crisp; very early .....	\$0.10	\$0.25	\$0.75	\$2.00
<b>Early Scarlet Globe.</b> Fine for forcing or open ground .....	.10	.25	.60	1.50
<b>Marshall's Glowing Ball.</b> A perfect forcing variety, bright fiery scarlet-red color .....	.10	.30	.75	2.00
<b>Sparkler.</b> Brilliant scarlet with white tip. Shape round, suitable for forcing or garden culture. ....	.10	.25	.60	1.50

**OUTDOOR VARIETIES**

<b>Turnip, Marshall's Perfection.</b> Brilliant red with white tip extending nearly half-way up the root. ....	.10	.25	.75	2.00
<b>Turnip, Early Scarlet.</b> Very early. The French favorite .....	.10	.25	.60	2.00
<b>Turnip, Scarlet, White-Tipped.</b> Very early for frames or outdoors .....	.10	.20	.50	1.50
<b>Turnip, Early White, or Box.</b> Flesh pure white and sweet .....	.10	.25	.60	2.00
<b>Turnip Comet.</b> A perfect ball shape. Color bright scarlet, remains crisp until very large .....	.10	.25	.60	2.00
<b>Olive-Shaped French Breakfast.</b> Pink and white; early .....	.10	.25	.60	2.00
<b>Olive-Shaped Deep Scarlet.</b> Crisp; very early .....	.10	.25	.60	1.75
<b>Olive-Shaped White.</b> Mild and fine for summer .....	.10	.25	.60	1.75
<b>Long Scarlet Short Top.</b> Very long; for frames or outdoors .....	.10	.25	.50	1.50
<b>Long Icicle.</b> Pure white; of fine flavor; suitable for forcing .....	.10	.25	.60	1.75

**WINTER VARIETIES**

<b>Long Black Spanish.</b> The popular Winter sort .....	.10	.25	.60	1.75
<b>Round Black Spanish.</b> Fine for Winter. ....	.10	.25	.60	1.75

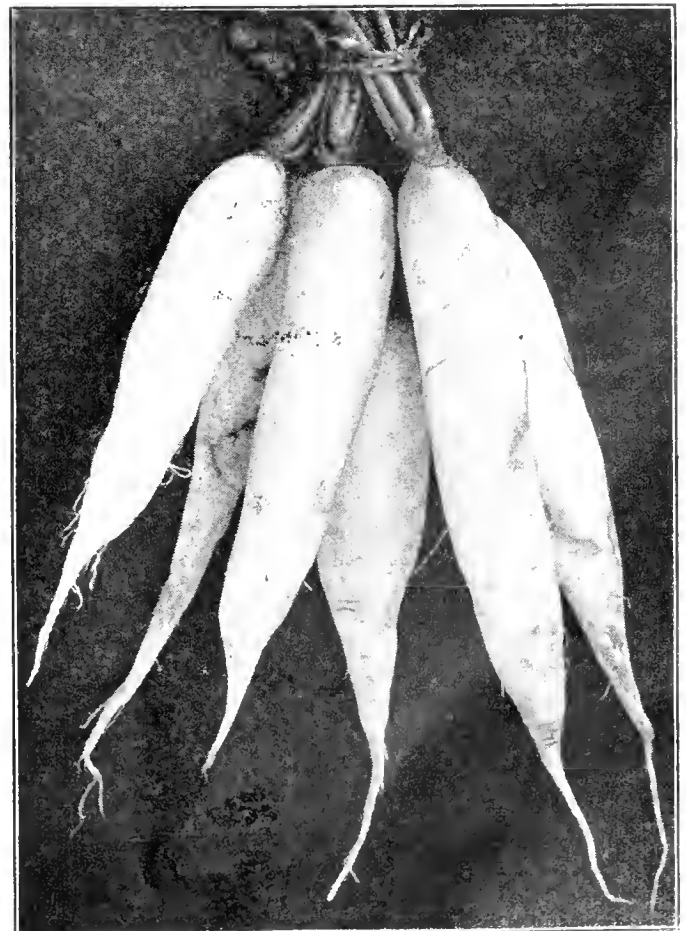

Long Icicle Radish

**SPINACH**

One ounce will sow 200 feet of drill, 10 to 12 lbs. an acre.

This is best developed and most tender and succulent when grown in very rich soil. For summer use sow early in spring in drills 15 inches apart, and make successive sowings every two weeks. For spring use sow in September, and cover lightly in November with light litter.

	Pkt.	Oz.	¼ lb.	Lb.
<b>King of Denmark.</b> A new variety for spring planting. Dark green crumpled leaves and very slow to go to seed.	\$0.10	\$0.20	\$0.30	\$0.90
<b>Long Standing.</b> A good Spinach for summer use. Deliciously tender. Dark green leaves	.10	.20	.30	.80
<b>New Zealand.</b> Makes a low spreading plant from which delicious tender greens can be gathered the entire summer. Fine flavor.	.10	.25	.60	1.50

	Pkt.	Oz.	¼ lb.	Lb.
<b>Perpetual Summer, or Spinach Beet</b> A Spinach of outstanding merit. Dark green leaves produced all summer long; of delicious flavor. It may be cut repeatedly during the season and it will grow again with renewed vigor. Hence its name "Perpetual". Highly recommended	\$0.10	\$0.30	\$0.85	\$2.50

	Pkt.	Oz.	¼ lb.	Lb.
<b>Prickly, or Winter.</b> Vigorous and hardy, recommended for fall sowing	\$0.10	\$0.15	\$0.30	\$0.75
<b>Savoy-Leaved, or Bloomsdale.</b> Good sized curled leaves, tender and finely flavored	.10	.20	.30	1.00
<b>Victoria.</b> A variety with thick dark-green leaves. Best long standing Spinach	.10	.20	.30	.75
<b>Viroflay Thick-Leaved.</b> A standard sort, equally good for early spring or fall sowing	.10	.20	.30	.75

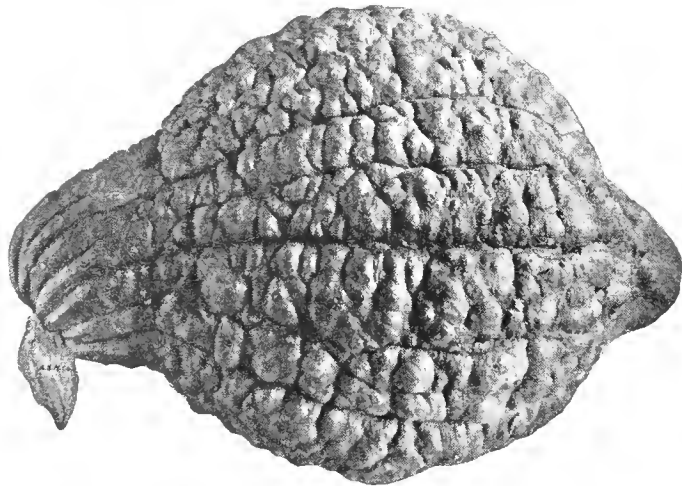

Mammoth Warty Hubbard Squash

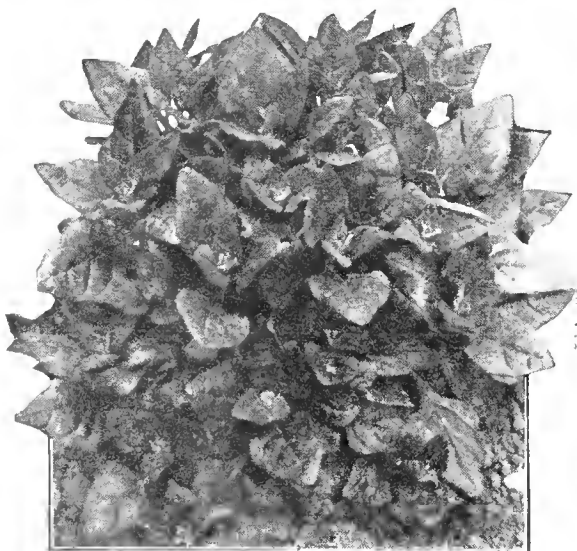

New Zealand Spinach

**SQUASH**

One ounce Early Squash will plant about 50 hills. One ounce Marrow Squash will plant about 25 hills.

The Squash succeeds best in good rich soil. It is not advisable to plant before May 15th. Sow in hills in the same manner as Cucumbers and Melons. Use seed freely, 8 to 12 seeds to the hill, to provide for losses by insects.

**BUSH VARIETIES**

	Pkt.	Oz.	¼ lb.
<b>Cocozelle Bush.</b> A fine variety; oblong shape; skin smooth, dark green, marbled yellow or pale green	\$0.10	\$0.30	\$1.00
<b>Improved Early White Bush Scallop.</b> A good early shipping variety	.10	.25	.75
<b>Giant Summer Crookneck.</b> Double the size of Summer Crookneck	.10	.30	.75
<b>Giant Summer Straightneck.</b> Fruits about 18 inches long, deep orange color and intensely warted	.10	.40	1.25
<b>Golden Custard.</b> Fine quality and cooks tender.	.10	.30	.75
<b>Golden Summer Crookneck.</b> Yellow fruit; distinct; best for summer	.10	.30	1.00
<b>Yellow Bush Scallop.</b> The popular yellow variety	.10	.30	1.00
<b>Zucca Pergola.</b> An Italian variety, 24 to 36 inches long, color pale green	.10	.40	1.25

**RUNNING VARIETIES**

<b>Blue Hubbard.</b> Of true Hubbard shape with rich blue-green skin and bright orange flesh of fine flavor	.10	.30	1.00
<b>Boston Marrow.</b> Oval; bright orange; flesh yellow and fine	.10	.25	.75
<b>Delicious.</b> Green skin; orange flesh; fine grained; sweet and dry	.10	.30	1.00
<b>Fordhook.</b> A desirable variety for summer and winter use; fruit oblong in shape, smooth yellow skin, flesh light yellow	.10	.30	1.00
<b>Golden, or Red Hubbard.</b> Flesh deep golden yellow; fine for private use	.10	.30	.75
<b>Improved Hubbard.</b> Well known and liked for late use	.10	.30	.75
<b>Mammoth Warty Hubbard.</b> Very large, covered with warts. Fine keeper	.10	.30	.75
<b>Table Queen or Acorn.</b> Acorn-shaped, thin ribbed dark green shell, yellow flesh	.10	.30	1.00

**ENGLISH VEGETABLE MARROWS**

The following varieties are well adapted for growing in this climate:

	Pkt.	Oz.	¼ lb.
<b>Long Green Bush.</b> Fruits long, pale green; rich flavor	\$0.15	\$0.40	\$1.25
<b>Long White Bush.</b> Creamy white; very prolific	.15	.40	1.25
<b>Moore's Long Cream.</b> Very long, pale cream color; trailing sort	.15	.40	1.25
<b>Vegetable Marrow.</b> Skin greenish yellow; flesh white; trailing variety	.15	.30	1.00

**TOBACCO SEED**

One ounce will produce plants for one acre.

**Connecticut Seed Leaf.** Suitable for growing in these latitudes; used for cigar wrappers. Pkt. 10c, oz. 30c.



Delicious Squash

**TOMATO**

One ounce will produce 1000 plants.

Sow thinly about the first week in March in a hotbed, greenhouse, window or sitting room, where the temperature is never below 60 degrees. When 2 inches high, set out the plants in boxes about 4 inches apart, or pot singly. About the first of June they may be transferred to the open ground. Set them deeply 4 feet apart.

**FORCING VARIETIES**

	Pkt.	½ oz.	Oz.
<b>Marshall's Prolific.</b> The finest medium-sized Tomato for forcing or outdoor planting. It is an enormous cropper, producing large clusters of bright scarlet fruit .....	\$0.25	\$1.50	\$3.00
<b>Essex Wonder.</b> A robust English variety; produces trusses of excellent quality fruits....	.25		
<b>Fillbasket.</b> A very heavy cropper. Smooth round fruit .....	.25	1.50	3.00
<b>Princess of Wales.</b> A variety of high merit. Plants robust in habit and laden with heavy clusters of medium size fruit .....	.25	1.50	3.00
<b>Stirling Castle.</b> Excellent for forcing as well as outdoor culture. Fruit medium size.....	.25	.75	1.50
<b>Sunrise.</b> A fine forcing variety; rich scarlet color .....	.25	.75	1.50
<b>Winter Beauty.</b> Fine forcer, fruits of good size, smooth and deep color .....	.25	1.50	3.00

**OUTDOOR VARIETIES**

<b>Break o' Day.</b> Early, disease resisting, globe shaped, scarlet fruited, and meaty.....	.15	.35	.60
<b>Bonny Best.</b> A very early bright red variety. Smooth, solid and uniform.....	.10	.35	.60
<b>Crimson Cushion.</b> Extra large, handsome, bright crimson .....	.10	.35	.60
<b>Golden Queen.</b> A good yellow sort; first-class quality; large and solid.....	.10	.35	.60
<b>John Baer.</b> A beautiful, brilliant red variety; perfect, solid, high crown fruits.....	.10	.40	.75
<b>Marglobe.</b> Fruits are large, smooth and globular, meaty and almost coreless. Very productive .....	.15	.50	1.00
<b>Marshall's National.</b> A very early, bright red, coreless variety .....	.25	1.00	2.00
<b>Marshall's Matchless.</b> Extra large, smooth and handsome; bright red; very solid.....	.10	.40	.75
<b>Oxheart.</b> The largest of all, purple fruits of axheart shape, very solid.....	.10	.40	.75
<b>Penn State.</b> A small compact plant type, very heavily set with globe shaped, rich scarlet fruits which are perfect and evenly colored..	.15	.50	1.00
<b>Ponderosa.</b> The largest variety in cultivation; very solid and meaty.....	.10	.40	.75
<b>Stone.</b> Very large, perfectly smooth; fine, bright scarlet .....	.10	.35	.60
<b>Tangerine.</b> Large orange color fruits the shade of a tangerine. Delightful flavor with a sub-acid piquancy .....	.25	.60	1.20
<b>The Pritchard or Scarlet Topper.</b> Globe shaped, early and disease resisting.....	.15	.50	1.00

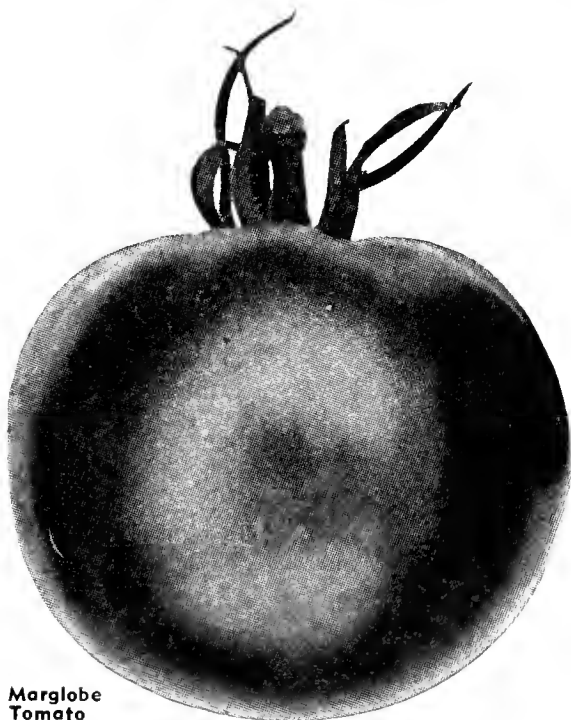

Marglobe Tomato



Scarlet Topper Tomato

**SMALL FRUITED TOMATOES**

	Pkt.	½ oz.	Oz.
<b>Red Cherry.</b> Small fruits; used for pickles; very handsome .....	\$0.15	\$0.40	\$0.75
<b>Red Currant.</b> Very small fruits; for preserves. ....	.15	.40	.75
<b>Red Peach.</b> Resembling a Peach; for preserves, pickles and exhibition.....	.15	.40	.75
<b>Red Pear.</b> Fruit handsome and solid; fine for preserves .....	.15	.40	.75
<b>Red Plum.</b> Bright red, round, regular; for pickles .....	.15	.40	.75
<b>Strawberry (Winter Cherry, or Husk Tomato).</b> Makes fine sauce.....	.15	.40	.75
<b>Yellow Cherry.</b> For pickles and preserves.....	.15	.40	.75
<b>Yellow Peach.</b> Beautiful clear yellow; perfectly resembles a Peach.....	.15	.40	.75
<b>Yellow Pear.</b> Handsome, yellow, Pear-shaped fruits .....	.15	.40	.75
<b>Yellow Plum.</b> Round and regular; bright yellow. ....	.15	.40	.75

**TURNIP**

One ounce will sow 200 feet of drill.

Turnips do best on highly enriched, light sandy or gravelly soil. Commence sowing the earliest varieties in April, in drills, from 12 to 15 inches apart, and thin out early to 6 or 9 inches in the rows. For a succession, sow at intervals of two weeks, until the middle of August.

	Pkt.	Oz.	¼ lb.	Lb.
<b>Early Milan, Purple Top.</b> Earliest of all, white with purple top.....	\$0.10	\$0.20	\$0.50	\$1.50
<b>Early Milan, Pure White, Selected.</b> Very handsome, pure white and as early as the above; flesh very sweet and tender .....	.10	.20	.50	1.50
<b>Early Snowball.</b> Small, and rapid growth; pure white .....	.10	.20	.50	1.50
<b>Golden Ball.</b> Very handsome; keeps fairly well .....	.10	.20	.50	1.50
<b>Quicksilver.</b> A perfect shaped round, white skinned, solid white flesh variety. Very quick growing and fine for exhibition and family use. The finest .....	.10	.20	.50	1.50
<b>Red Top, Globe-shaped.</b> A standard sort in the New York market.....	.10	.20	.50	1.50
<b>Seven Top.</b> Grown exclusively for the tops, which are used for greens .....	.10	.20	.50	1.50
<b>Yellow Aberdeen.</b> A hardy and productive variety of excellent quality.....	.10	.20	.50	1.50

**RUTABAGA**

Seed should be sown the end of June or July. Desirable for table use and feeding stock.

	Pkt.	Oz.	¼ lb.	Lb.
<b>Marshall's Matchless.</b> A purplish bronze variety, with single tap root and small top. Excellent quality.....	\$0.10	\$0.25	\$0.75	\$2.50
<b>American Purple Top.</b> A strain of Purple Top Yellow.....	.10	.20	.50	1.50
<b>White-Fleshed.</b> Large and productive..	.10	.25	.75	2.00

**FREE DELIVERY.** We deliver vegetable and flower seeds when cash accompanies your order.

# HERBS

Plant in the spring, when the ground is warm, in drills, covering lightly. When the plants are well up, thin out or transplant to about 4 inches apart. They should be harvested on a dry day just before the blossom develops, dried quickly and bottled, or closely packed in dry boxes with the air entirely excluded.

	Pkt.	Oz.
<b>Anise.</b> Annual. Used for flavoring and garnishing....	\$0.15	\$0.40
<b>Balm.</b> Perennial. Leaves have a fragrant odor and are used medicinally.....	.15	.50
<b>Basil, Sweet.</b> Annual. Used for flavoring soups, stews, etc. ....	.10	.50
<b>Borage.</b> Annual. Leaves are used for flavoring, and bees are attracted by the flowers.....	.10	.50
<b>Caraway.</b> Perennial. Used for flavoring confectionery, bread, etc. ....	.10	.40
<b>Catnip.</b> Perennial. Sometimes used in medicine.....	.15	.75
<b>Chives.</b> Valued for their mild onion-like flavor .....	.10	.75
<b>Coriander.</b> Annual. Used in the manufacture of confectionery .....	.15	.50
<b>Dill.</b> Biennial. The seeds are aromatic and pungent. Used in pickling.....	.10	.30
<b>Fennel, Florence.</b> The roots are boiled, also used as salad .....	.10	.40
<b>Fennel, Sweet.</b> Perennial. Leaves when boiled are used in sauces.....	.10	.40
<b>Horehound.</b> Perennial. Used medicinally, also for seasoning .....	.15	.60
<b>Hyssop.</b> Perennial. Used medicinally. The leaves have a pungent taste. ....	.15	.50
<b>Lavender.</b> Perennial. Yields an oil used in medicine and perfumery .....	.10	.50
<b>Marigold, Pot.</b> For medicinal purposes.....	.10	.50
<b>Marjoram, Sweet.</b> Annual. Aromatic and fragrant. Much used in flavoring.....	.15	.75

	Pkt.	Oz.
<b>Mint.</b> Plants only.		
<b>Rosemary.</b> Perennial. Leaves fragrant, with warm, pungent, bitterish taste .....	\$0.15	\$0.75
<b>Sage.</b> Perennial. More used than any other herb for dressings and seasoning.....	.10	.50
<b>Summer Savory.</b> Annual. Used for flavoring soups and dressings .....	.15	.75
<b>Tarragon, or Estragon.</b> .....	.25	3.00
<b>Thyme.</b> Perennial. Used for seasoning. Also used medicinally .....	.15	1.00
<b>Wormwood.</b> Perennial. Used medicinally and is beneficial for poultry.....	.15	.60

## PLANTS OF HERBS

To meet the increasing demand for plants of the most popular herbs, we can supply the following:

- Balm** (*Melissa officinalis*).
- Catnip** (*Nepeta cataria*).
- Chives** (*Allium Schoenoprasum*).
- Hop** (*Humulus lupulus*).
- Hyssop** (*Hyssopus officinalis*).
- Lavender** (*Lavandula vera*).
- Mint** (*Mentha viridis*). Spearmint.
- Peppermint** (*Mentha piperita*).
- Rosemary** (*Rosmarinus officinalis*).
- Rue** (*Ruta graveolens*).
- Sage** (*Salvia officinalis*).
- Spearmint** (*Mentha spicata*).
- Tarragon** (*Artemisia dracunculus*).
- Thyme** (*Thymus vulgaris*).
- Wormwood** (*Artemisia absinthium*).

Plants of any of the above: 3 for 90c; 10 for \$2.50. Not less than three of one variety sold.

# Farm and Field Seeds

**BARLEY.** 48 lbs. to the bushel, 2 bushels to the acre.

**Oderbrucker.** A six-rowed bearded variety..... Bu. \$3.50

**BEANS.** Sow 1/2 to 3/4 bushel to the acre.

**Soja Bean, E. Black Wilson.** Valuable as a forage crop and for fertilizing the soil. Thrives well in hot and dry weather.... \$5.00

**BEET, MANGEL-WURZEL.** Sow 6 to 8 pounds to acre.

**Champion Yellow Globe.** Bright orange color; globe-shaped and of excellent quality..... Lb. \$0.75

**Golden Tankard.** An enormous yielder per acre. Flesh deep yellow .....

**Mammoth Lang Red.** The largest and heaviest cropper of all the Mangels .....

**BUCKWHEAT.** 48 pounds to the bushel. Sow 1 bushel to the acre.

**Japanese.** Earliest and most productive of the Buckwheats .....

**FIELD CORN.** 8 quarts will plant 1 acre in hills. 3 bushels will sow 1 acre broadcast.

### FLINT VARIETIES

**Longfellow.** A large-eared Flint variety. Ears 8-rowed, often 14 to 15 in. long..... Peck Bu. \$1.00 \$3.50

**Luce's Favorite.** Ears large and abundant foliage. Valuable for ensilage or as a shell corn..... 1.25 4.00

### DENT VARIETIES

**Improved Leaming.** Large ears, deep-grained and of deep orange color .....

**Lancaster County Sure Crop.** A good variety for crib or silo. Long ears with deep yellow grains..... 1.00 3.50

### FODDER AND ENSILAGE VARIETIES

**Golden Eureka.** The plants grow 12 to 15 ft. high. Valuable for ensilage or as a yellow Dent Corn..... 1.25 4.00

**Southern Horse Tooth.** A large, leafy grower, especially valuable for ensilage..... 1.00 3.00

**Sweet Fodder.** Succulent and nutritious for feeding green .....

**MILLET, Golden.** Very large crop, though not so early as Hungarian. Grows 3 to 5 ft. high. Sow 1 bushel to the acre, 48 lbs. to the bushel..... \$4.25 \$8.00

**Hungarian.** A favorite summer forage crop. Sow in June. Withstands heat and drought well. Plant about 3 pecks to 1 bushel per acre, 48 lbs. to the bushel .....

**Japanese.** Grows very tall, 6 to 7 ft.; makes valuable forage. Sow about 15 lbs. per acre, 35 lbs. to the bushel .....

**OATS.** Sow 2 to 3 bushels to the acre, 32 lbs. to the bushel. \$5.50 \$15.00

**Storm King.** The heads measure from 8 to 10 in. and the kernels are of immense size, thick, plump and heavy. It is very early has great length of straw. Bu. \$2.25, 10 bus. or over \$2.00 per bu.

**Canada Cluster.** A true side Oat and heavy cropper. Bu. \$2.25, 10 bus. or over \$2.00 per bu.

**PEAS, Canada Field.** Valuable for cattle feeding and ensilage. Sow broadcast in the Spring at the rate of two bushels to the acre. \$1.50 pk., \$4.50 bu.

**Cow Peas, Whippoorwill.** A very early maturing variety of upright or bush growth. Sow 2 bushels per acre, 60 lbs. per bushel. Bu., \$6.00.

**RAPE, Dwarf Essex.** Fine for sheep pasture; valuable as a soil enricher. Plant in June or July in drills at the rate of 3 lbs. per acre, broadcast 5 lbs. per acre. Lb. 25c, 100 lbs. \$15.00.

**RYE.** For grain, 1 bushel to the acre; for foliage or soiling, 1 1/2 bushels, 56 lbs. to the bushel.

**Giant Winter.** Popular as a cover crop. If allowed to mature will produce a heavy crop of grain, and a fine quality of straw if cut about July 1. Pk., \$1.00, bu. \$3.00.

**SUNFLOWER, Mammoth Russian.** Very productive, large heads with large seeds. Valuable for poultry; 5 lbs. will plant 1 acre. Lb. 25c, 25 lbs. \$4.50, 100 lbs. \$16.00.

**VETCHES, OR TARES. Spring Vetches** (*Vicia sativa*). Highly valuable for soiling or for green manuring. Sometimes grown with Oats for mowing and feeding to stock. Use 40 to 60 lbs. to the acre. Lb. 20c, 100 lbs. \$12.00.

**Winter Vetches** (*Vicia villosa*). Also called Sand Vetch, or Hairy Vetch. Recommended for fall sowing with Rye. A valuable food for stock in early Spring. Use 30 to 50 lbs. per acre. Lb. 40c, 100 lbs. \$25.00.

**WHEAT.** The seed Wheat we offer is grown in Pennsylvania by a very reliable grower, especially for seed purposes. Sow 1 1/2 bushels to the acre.

**Marquis Spring.** A very early beardless Wheat producing larger yields than any other kind. Sow early about 2 1/2 bushels per acre. Bu. \$3.50.

**Leap's Prolific.** A very hardy, beardless white chaff and dark amber grain. Market price.

Prices on all Farm Seeds are subject to market fluctuations.

# Summer Flowering Bulbs

## ACIDANTHERA BICOLOR

A valuable bulbous plant for outdoor culture. Very fragrant, creamy white color with chocolate blotch, on stems fifteen inches long. The bulbs should be treated like Gladiolus. 3 for 60c, doz. \$2.00, 100 \$14.00.

## AGAPANTHUS

**umbellatus** (Blue Lily of the Nile). A most desirable plant for outdoor decoration; planted in large pots or tubs on the lawn or piazza. Pot-grown plants. 6-in., each \$1.50, doz. \$15.00.

## AMARYLLIS

They should be grown in rich sandy loam, with good drainage, and require abundant moisture when growing; but at their season of rest water should be given sparingly.

### New Hybrids. Hippeastrum

We are in a position to offer, for the first time, an exceptionally fine strain bearing enormous flowers, in separate colors, as follows: **Solid Red. Red with white star. White and Red. White with pink. White.**

**Separate Colors.** Each \$1.00, doz. \$10.00.

**All Colors Mixed.** Each 60c, doz. \$6.00.

**Formosissimum** (Jacobean Lily). Brilliant scarlet. Each 30c, doz. \$3.00.

## AMORPHOPHALLUS RIVIERI

### African Lily

The dark red Colla-shaped flower precedes the leaves on this interesting plant. The stem is mottled green and white. The foliage, which appears later, stands on a stalk resembling an umbrella and makes a very ornamental plant.

Extra large bulbs, each \$2.50. Smaller size, each \$2.00.

## ANEMONES

Dainty summer flowering plants with flowers 2½ in. in diameter on strong stems.

**Coronaria, St. Brigid.** Double and semi-double. Doz. \$1.20, 100 \$8.00

## BEGONIAS

Splendid pot plants for the house or greenhouse, and especially valuable for bedding, flowering in the greatest profusion throughout the summer. For bedding they should be started in hotbed in March or April.

### SINGLE TUBEROUS-ROOTED

**Separate Colors: Pink, Salmon, Scarlet, White, Yellow or Mixed.** Each 30c, doz. \$3.00, 100 \$24.00.

### DOUBLE TUBEROUS-ROOTED

**Separate Colors: Pink, Salmon, Scarlet, White, Yellow or Mixed.** Each 30c, doz. \$3.00, 100 \$24.00.

## CALLAS (Richardia)

Splendid pot plants or for outside planting. They may be started inside and safely planted out in May.

**Aurata.** A lemon-yellow summer flowering variety. Each 30c, doz. \$3.00.

**Golden Roosevelt.** A summer blooming Calla with yellow flowers and spotted foliage. Each 50c, doz. \$5.00.

**Mrs. Roosevelt.** White flowers tinged with yellow, leaves spotted. Will bloom continuously through the summer. Each 25c, doz. \$2.50, 100 \$16.00.

**Large Bulbs.** Each 50c, doz. \$5.00, 100 \$35.00.

## CALADIUM ESCULENTUM

### (Elephant's Ear)

Grand, tropical plant. A favorite for specimens on the lawn. Height 3 to 4 ft.

**Large Bulbs,** 7 to 9 in. circum. Each 25c, doz. \$2.50.

**Mammoth Bulbs,** 9 to 11 in. Each 35c, doz. \$3.50.

## FANCY-LEAVED CALADIUMS

Beautiful, variegated-leaved plants adopted for pot culture or bedding if given sheltered positions. Bulbs planted in late May make a pretty display in borders or for edging taller plants.

**Fancy-leaved Mixed Varieties.** Each 35c, doz. \$3.50, 100 \$25.00.

## CHLIDANTHUS FRAGRANS

A summer flowering bulb similar to Zephyranthes, of the Amaryllis order. Flowers yellow, in June and July, on stems 12 inches long. Very fragrant, 3 for 40c, doz. \$1.50, 100 \$10.00.

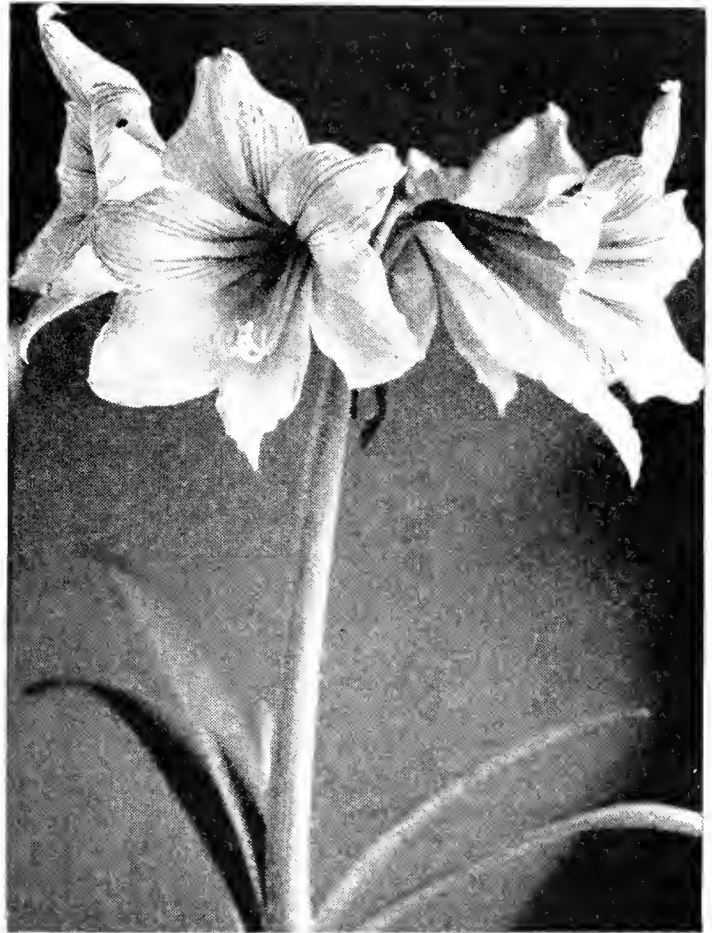

Amaryllis Hybrid

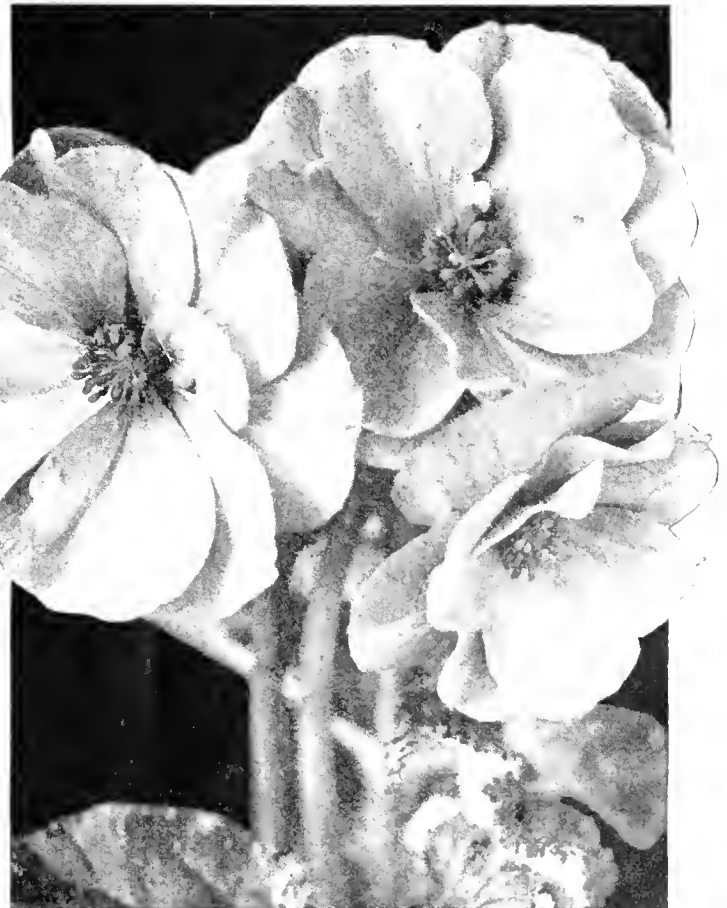

Tuberous Rooted Begonia

SUMMER FLOWERING BULBS—Continued



Hyacinthus Candicans



Gloriosa Superba

CANNAS

Cannas should not be planted until the warm weather sets in, or about May 15th. If planted too early the bulbs are apt to rot. The following are a selection of the largest flowering varieties which we can recommend for bedding or borders. We shall be pleased to supply other varieties not named at catalog prices.

MATCHLESS CANNAS

- American Beauty.** A velvety Oriental carmine, unusually attractive. 5 ft. 6 for \$1.00, doz. \$1.50.
- Golden Wedding.** The best of the dwarf yellow varieties. 3 ft. 6 for \$1.25, doz. \$2.00.
- Hollywood.** Orange-pink, shading out of salmon-orange at the tips of the petals. 4 ft. 6 for \$1.00, doz. \$1.50.
- King Midas.** Very large flowers of glittering gamboge-yellow. 5 ft. 6 for \$1.10, doz. \$1.50.
- Mrs. A. F. Conard.** A beautiful salmon-pink. A very popular variety. 4 ft. 6 for \$1.00, doz. \$1.75.
- Mrs. Pierre S. du Pont.** For sheer beauty this queen of bright pink Cannas is unequalled. Very large flowers. 3 for \$1.00, doz. \$3.50.
- Palm Beach.** Broad long-petaled flowers of maize-yellow, with a faint blush of pink. 4 ft. 6 for \$1.00, doz. \$1.50.
- Razzle Dazzle.** Crimson-maroon, each petal edged with brilliant yellow. 4 ft. 6 for \$1.00, doz. \$1.50.
- The Ambassador.** Brilliant, large cherry-red flowers. Bronze foliage. 4 ft. 6 for \$1.00, doz. \$1.75.
- The President.** A rich glowing scarlet, immense, firm flowers. 4 ft. 6 for \$1.00, doz. \$1.75.

Prices quoted are for dormant roots.

Plants can be supplied at 75c per dozen extra for delivery in May and June.

GLORIOSA SUPERBA

This handsome African tuberous rooted plant known as the Climbing Lily has been used formerly as a greenhouse climber but, after repeated tests, we find that it may be enjoyed by the amateur as a most attractive climber. They may be grown on a trellis as they find support through numerous tendrils. Grows 6 to 8 feet in height and produces numerous flower stems 12 inches in length with large reflexed lily-like flowers, opening yellow but changing to orange-red and deep scarlet. The tubers should be planted in a warm sunny situation or to insure early growth they may be started inside. In fall the tubers should be lifted and placed in dry sand in a warm cellar for the winter. 75c each, 3 for \$2.00, \$7.50 per doz.

GLOXINIAS

Handsome summer-flowering, tuberous-rooted plants adapted for pot culture. One bulb should be used for a 4-in. pot, using properly mixed soil and care being taken in watering.

	Each	Doz.
Red, White or Blue.....	\$0.40	\$4.00
Choice Mixed Colors.....	.40	4.00

Bulbs ready for delivery in February.

HYACINTHUS CANDICANS  
(Cape Hyacinths)

A snow-white summer-flowering Hyacinth, growing 3 to 5 feet in height, gracefully surmounted with from twenty to thirty pure white, bell-shaped flowers.

**Extra Large Bulbs.** Each 15c, doz. \$1.50, 100 \$10.00.  
If wanted by mail add 15c per doz. for postage.



Canna, Mrs. Pierre S. du Pont



SUMMER FLOWERING BULBS—Continued

**ISMENE (Calathina Grandiflora)**

One of the best of our summer-flowering bulbs. Clusters of large, fragrant, pearly white flowers, resembling the Amaryllis family.  
**Extra Large Bulbs.** Each 30c, doz. \$3.00, 100 \$22.00.

**LILY-OF-THE-VALLEY PIPS FROM COLD STORAGE**

We have in storage a large quantity of Dresden Pips for forcing at any season of the year.  
 Lily-of-the-valley can be forced in about four weeks from cold storage pips. We cannot supply less than 250 pips.  
**Marshall's Matchless Pips.** Case of 250 for \$20.00.

**MADEIRA or MIGNONETTE VINE**

A rapid growing, beautiful and popular vine, covering a large space in a short time. Heart-shaped leaves of a light green, with numerous racemes of feathery flowers of delightful fragrance.  
**Mammoth Bulbs.** Each 15c, doz. \$1.50, 100 \$10.00.

**MONTBRETIAS**

Hardy summer-flowering bulbous plants which should be planted in the early spring and will flower in September. Bulbs may be left in borders during Winter, if well covered, and will flower earlier than spring-planted stock.

**NEW GIANT FLOWERING HYBRIDS**

These magnificent new Montbretias have erect flowers measuring 4 inches across, borne on stems 4 feet in height.

	Doz.	100
<b>His Majesty.</b> Immense sized flowers of brilliant red with yellow center. An outstanding variety	\$3.00	\$20.00
<b>James Coey.</b> Large broad petalled flowers of a rich deep vermilion-scarlet with golden-orange luster. Yellow center	2.25	16.00
<b>Queen Alexandro.</b> Immense flowers of chrome-yellow with carmine blotch at base of petals	2.25	16.00
<b>Una.</b> Large, well-shaped flowers of rich apricot with carmine blotch	2.25	16.00

**OTHER GOOD MONTBRETIAS**

The following have been selected as the most desirable of the older varieties.

	Doz.	100
<b>Fire King.</b> A glowing scarlet with large flowers of good quality	\$0.75	\$5.00
<b>George Davidson.</b> A free flowering variety, large pale yellow flowers	1.00	6.00
<b>Lord Nelson.</b> Orange shaded red, vermilion shaded outside	1.50	9.00
<b>King Edmund.</b> Giant rich golden with brown markings in throat	1.00	7.00
<b>Lady Hamilton.</b> A lovely large yellow, shading to apricot	1.50	9.00
<b>Mixed varieties.</b> A splendid mixture of good varieties	.60	4.00

**NERINE**

**Bowdeni.** A grand species from Cape Colony, with large umbels of pink flowers with a rose-colored line down each petal. We offer properly ripened, extra large flowering bulbs, July delivery. Each \$1.50, doz. \$15.00.  
**Fothergilli major.** The finest of all the Nerines, producing large red flowers with a golden glitter as if sprinkled with gold dust. Adapted for pots and greenhouses. Well ripened bulbs for delivery in July. Each \$1.00, doz. \$10.00.  
**Sorniensis (The Guernsey Lily).** A bulbous plant for greenhouse or conservatory, producing heads of red flowers before the leaves. Each 25c, doz. \$2.50, 100 \$18.00. Delivery in July and August.

**ALL ABOUT FLOWERING BULBS**

By T. A. Weston

This book gives all the information the home gardener requires on the culture of bulbs of all seasons for outside and in the house. 186 pages, 68 illustrations, 8 color plates. Postpaid \$2.00.

**OXALIS**

No bulb is more valuable for edging the borders of walks or flower beds. Elegant foliage and pretty flowers, bloom quickly after planting. The bulbs should be taken up and stored in the fall in Northern latitudes.

- Dieppei.** Pure white.
- Lasiandra.** Rosy pink, cut foliage.
- Shamrock.** Clover-like foliage; pink flowers.
- Mixed Colors.** Several varieties.
- Mammoth Bulbs.** Doz. 30c, 100 \$2.00.



Montbretia

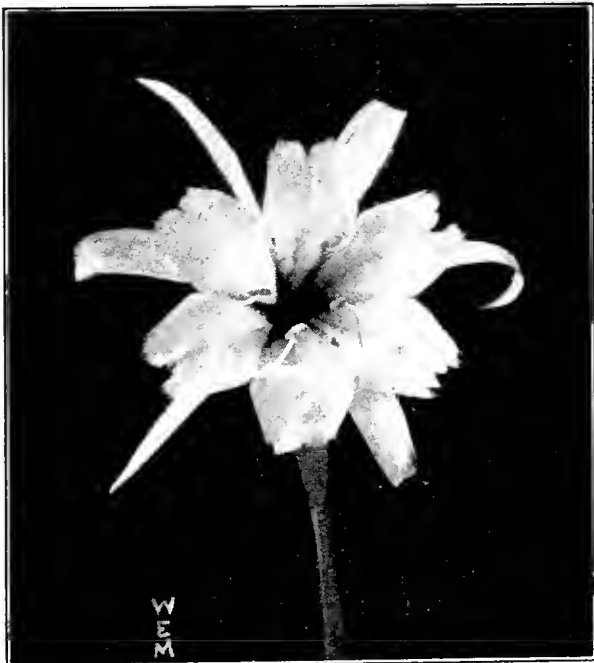

Ismene



Lily-of-the-Valley

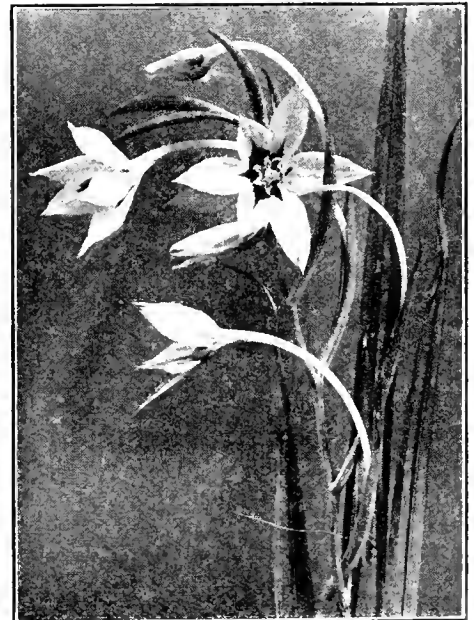

Acidanthero Bicolor (See page 51)

SUMMER FLOWERING BULBS—Continued

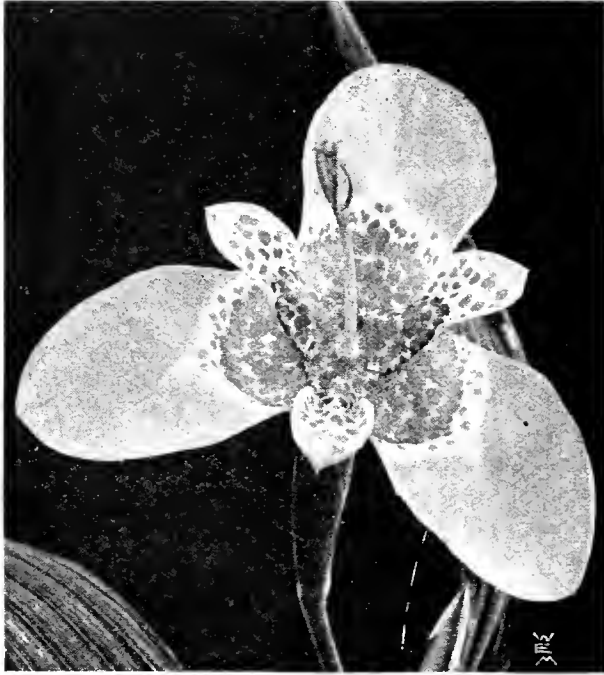

Tigridio

**TIGRIDIA (Shell Flower)**

Very showy summer flowering bulbs growing about 24 inches in height. Bulbs should be planted 2 inches deep and 6 inches apart and treatment similar to gladiolus should be given them.

**pavonia rosea.** A very handsome flower with salmon-rose, spotted flowers. 6 for \$1.00, doz. \$2.00, 100 \$12.00.

**pavonia, Mixed Colors.** 6 for 75c, doz. \$1.50, 100 \$10.00.

**TRITOMA**

Valuable hardy border plants adapted for cutting and long flowering period.

The roots of Tritoma should be lifted in the fall and stored in cool cellars or frames for the winter in all the northern states.

**grandis (Pfitzeri).** Free flowering orange-scarlet, shading to salmon-rose at the edge. Height 2 to 3 ft. 3 for 90c, 10 for \$2.50.

**rufa.** A very dainty yellow flower for cutting; and constant bloomer from June until frost. Height 2½ feet. 3 for \$1.00, 10 for \$3.00, 100 \$25.00.

**rufa Hybrids.** A very delightful and charming range of colors. From a pure white they run into pale and deep yellows, bronzes, oranges, terra-cotta, coral, deep pinks and reds. A galaxy of artistic shades which will find a ready welcome from gardening enthusiasts seeking the unique and unusual. Price 3 for \$1.25, 10 for \$3.50, 100 for \$30.00.

**TUBEROSES**

One of the most fragrant and popular of the summer flowering bulbs. May be started in hotbeds or pots, or planted in open ground after the first day of May.

	Each	Doz.	100
<b>Excelsior Double Pearl.</b> Extra fine bulbs . . . . .	\$0.15	\$1.25	\$8.00
<b>Armstrong's.</b> The single everblooming Tuberose . . . . .	.15	1.25	8.00

**VALLOTA PURPUREA  
SCARBOROUGH LILY**

An evergreen bulbous plant of easy culture. It is one of the most ornamental of the Amaryllis family. It makes a fine pot plant and will grow continually throughout the year, flowering usually in August or September. Large bulbs. Each 75c, doz. \$7.50.

**ZEPHYRANTHES  
ZEPHYR FLOWER OR FAIRY LILIES**

A hardy, dwarf, bulbous plant, flowering in great profusion in the summer. Bulbs should be lifted and stored in the fall in Northern latitudes.

**rosea.** Beautiful clear rose, very large flowers. 3 for 50c, doz. \$1.50, 100 \$10.00.

**candida.** The fall flowering white variety. 3 for 50c, doz. \$1.50, 100 \$10.00.



Vallota Purpurea

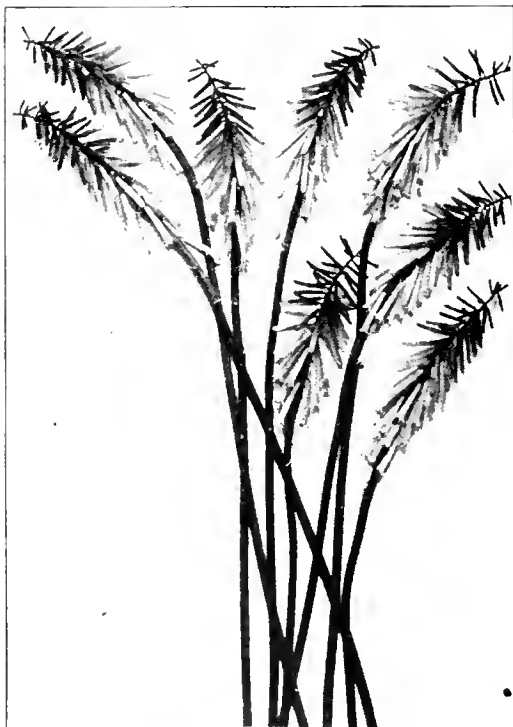

Tritoma, Rufa Hybrids

~~~~~  
**The Book  
of Bulbs**

A very useful book for all lovers of bulbs and their cultivation.

**\$2.00, Postpaid**  
~~~~~

~~~~~  
**ALL ABOUT  
FLOWERING  
BULBS**

By T. A. Weston

This book is written especially for the amateur on the cultivation of all Bulbs. 186 pages, 68 illustrations.

**\$2.00**  
~~~~~



Zephyranthes

# Marshall's Matchless Dahlias

The Decorative Dahlias have very large flowers with broad petals; they all flower freely on long, strong stems. Our list of varieties is selected from the best adapted for exhibition and cutting.

The varieties marked F.D. are Formal Decoratives and varieties marked I.D. are Informal Decoratives.

## MARSHALL'S DECORATIVES

### Our Recent Introductions

The varieties preceded by an asterisk (\*) are recommended for cutting.

- |   |                  |
|---|------------------|
|   | Each             |
| * <b>A. E. Wheeler.</b> I.D. A bright pink with no trace of lavender. Grows a 5-ft. straight, stiff stem with a 10-inch flower. Worthy of a place in every good collection .....  | \$ 5.00          |
| * <b>Marshall's Autumn.</b> F.D. Color red and bronze. A superb flower on long stem. Fine for cutting .....   | 2.50             |
| * <b>Marshall's Beauty.</b> F.D. A perfect Jersey's Beauty in orchid color. Excellent for cutting .....   | .75              |
| * <b>Marshall's Blue Gem.</b> F.D. The color is the nearest approach we have to blue. Perfect large blooms on long, stout stems. ....   | .75              |
| <b>Marshall's Cameo.</b> F.D. Produces a 12-inch flower on the top of a strong stem. Color cameo-pink. A pleasing color and very productive .....   | 5.00             |
| <b>Marshall's Gem.</b> A gem for cutting. Jersey's Beauty color with a slight suffusion of bright rose. Stems 4 feet ....   | .75              |
| <b>Marshall's Giant.</b> I.D. A perfect 14-inch flower which can be cut with 6-ft. stem. Color white with light lemon shading. Plants grow 8 feet tall with stout stems. Flower held upright. It wins easily in the largest bloom class. We guarantee it to give perfect satisfaction. Plants .....   | 7.50             |
| <b>Marshall's King.</b> I.D. Flower rosy red with pyrite of yellow in center of petals. Plant a strong grower. Stems 5 feet. ....   | 3.50             |
| <b>Marshall's Lavender.</b> I.D. A giant flower of pure lavender .  | .75              |
| <b>Marshall's Madonna.</b> I.D. A massive 12-inch flower with wonderful formation. Scored 89 per cent at trial grounds and judges noted it was a 100 per cent perfect flower. At the Mid West Show it was declared the best white in commerce. Won the Achievement Medal at Rockville Center. Produces flowers that can be cut with 3-ft. stems on a natural growing plant. Awarded three Honor Rolls. .... | 3 plants \$25.00 |
| <b>Marshall's Matchless.</b> I.D. A huge staghorn decorative of light orchid shading to Cattleya in center. Can easily be grown 12 inches in diameter and cut with a four foot stem .....   | 1.00             |



Marshall's Madonna



Marshall's King

- |   |         |
|---|---------|
|   | Each    |
| * <b>Marshall's Orchid.</b> F.D. White with suffusion of Cattleya on tips of the petals. A beautiful color under artificial light ..... | \$0 .75 |
| * <b>Marshall's Pink.</b> F. D. A wonderful pink. Long stiff stem, a wonderful robust grower, and one of the best for cutting .....     | .50     |
| * <b>Marshall's Poinsettia.</b> I.D. A wonderful cut flower variety. Color same as Poinsettia .....                                     | 2.50    |
| * <b>Marshall's Red Beauty.</b> F.D. Wonderful bright velvety red, long stems, a fine cut flower and good keeper .....                  | 1.00    |

- |   |        |
|---|--------|
|   | Each   |
| * <b>Marshall's Superb.</b> F.D. Light orchid pink; good grower on long stems. Fine for cutting .....   | \$3.00 |
| * <b>Marshall's White.</b> F.D. A large pure white .....  | .75    |
| <b>Marshall's Triumph.</b> F.D. A seedling from Jersey's Beauty with all its good habits, stem five feet, robust grower and will keep a week. Color brilliant dark velvety red. A sterling variety .....                                  | .75    |
| * <b>Mrs. A. E. Wheeler.</b> F.D. A wonderful decorative. The color is beautiful, fuchsia, shading to magenta with reverse of petals striped white showing in the center. Stem long and stiff .....                                       | .50    |
| <b>Mrs. W. E. Marshall.</b> F.D. Very large blooms of silvery lavender slightly suffused white. Perfect stems and ideal grower. Flowers held erect, making it a perfect exhibition flower .....   | .75    |
| * <b>W. E. Marshall.</b> F.D. Large brilliant gold flowers on long stems. A perfect grower and good keeper. Should be in every collection. ....   | 1.50   |
| * <b>Wm. Alexander.</b> I.D. Bright and cheerful like its namesake. A beautiful shell-pink with a light margin on each petal of light orchid. A wonderful grower with good 4-ft. stems. Average flowers 9 inches across .....             | 5.00   |
| <b>Wemca Beauty.</b> F.D. A beautiful white with light pink shadings on the edge of the petals. Distinct and worthy of a place in every collection .....  | 2.00   |
| <b>Wemca Eureka.</b> F.D. At last we have found a grand pure white with heavy petals on good stems. One of the best whites grown. Never stunts, a good keeper and insect proof. In our grower's field this was a noteworthy variety. .... | 5.00   |
| <b>Wemca Giant.</b> F.D. A wonderful producer of perfect 12 inch flowers without forcing. Insect proof, good stem, free-flowering. Color bright Chinese orange .....  | 1.50   |
| <b>Wemco Red Giant.</b> F.D. A very large bright ruby-red flower often 12 inches on good stiff stems. A good grower and producer of an abundance of flowers .....   | 1.00   |

MARSHALL'S DECORATIVE DAHLIAS—Continued

SUPREME DECORATIVE DAHLIAS

	Each	Each
<b>America's Sweetheart.</b> I.D. A clear pure yellow without shadings. Flower 12 inches or more produced on straight sturdy stems. Plants average 5 feet in height .....	\$ 5.00	
<b>Arelida Lloyd.</b> I.D. A sport of Jane Cowl with all its good qualities. Color lemon-yellow .....	4.00	
<b>Betty Zane.</b> I.D. A color admired by all. Bright erosine-pink. Flowers 12 inches on perfect stems .....	2.00	
<b>Bromwell's Pink.</b> A beautiful bright rose-pink flower often 11 inches across held facing on good stem .....	5.00	
<b>Buckeye Flame.</b> I.D. A very large flower of coral-rose....	1.50	
<b>Buckeye King.</b> F.D. A glowing gold color .....	1.00	
<b>California Idol.</b> I.D. A clear bright self colored yellow. An early and free bloomer. Flowers 14 inches .....	3.00	
<b>California Rose.</b> I.D. Clear bright rose and a particularly beautiful flower for cutting. Very large flower but extremely graceful .....	3.00	
<b>Cameo.</b> I.D. A large luscious colored flower, shaded half way between old rose and salmon .....	1.00	
<b>Chemar's Curly Locks.</b> I.D. The admiration of all who saw it growing in gardens and the field. The petals are exceptionally long and curled and twisted, forming a beautiful 12-inch flower. The color is bright gold, shaded apricot. Flowers held facing on long canelike stems. Height 7 feet. Foliage dark and insect resistant .....	3 plants \$15.00	
<b>Chinese Lantern.</b> F.D. A glorified Jersey's Beacon. A perfect Chinese red .....	2.50	
<b>Dixie Queen.</b> F.D. A fine yellow on long stems for cut flowers	1.00	
<b>Dorothy Stone.</b> F.D. A shade lighter than Kathleen Norris..	1.00	
<b>Edith Carder.</b> A giant flower on long stiff stems. Color Cyclamen pink. Plants .....	2.50	
<b>Full Moon.</b> I.D. A wide petaled, big clear shade of yellow. One of the most outstanding big flowers .....	1.50	
<b>Golden Eclipse.</b> F.D. A clear golden yellow with salmon or flesh shadings in the middle .....	1.00	
<b>Golden Goblin.</b> F. D. A rich golden color and a perfect formal type, with perfect stems. Everyone likes its sturdy habits. Plants .....	1.00	
* <b>Good Night.</b> I.D. A great garden and exhibition variety. Blood-red shaded maroon .....	.75	
<b>Grandee.</b> I.D. This Dahlia is exploited on size in the greatest bloom class. It is a striking combination of Spanish red and golden yellow. Fine form and good stems .....	2.00	
<b>Hunt's Velvet Wonder.</b> I.D. The flowers are deep rosy magenta blending into a true purple. Broad petals in a 10-inch flower .....	3.00	
* <b>James Kirby.</b> F.D. A giant red of exceptional keeping quality. Wonderful stem and size of flower.....	1.00	
<b>Jersey's Majestic.</b> I.D. A giant Dahlia. Color a blend of salmon, old gold and rose .....	1.50	
* <b>Jim Moore.</b> I.D. Primrose yellow shaded gold and suffused salmon. A good healthy grower .....	1.00	
<b>J. K. Alexander.</b> I.D. A giant red, often 12-inch flowers... ..	1.50	
<b>Judge Samuel Seabury.</b> I.D. Color, flesh or amaranth-pink shading to creamy white in center. Will give 10-inch flower .....	4.00	
<b>Kemp's Violet Wonder.</b> I.D. Bright violet-purple .....	1.00	
<b>King of Blacks.</b> F.D. A dark velvety maroon .....	1.00	
<b>King Supreme.</b> F.D. A dark red sport of Jersey's Beacon ...	1.00	
<b>Lady Moyra Ponsonby.</b> I.D. A clear light lemon-yellow on long stems .....	1.50	
<b>Linna Moe.</b> I.D. Bright yellow. A good exhibition variety with a 14-inch flower .....	3.00	
<b>Lord of the Autumn.</b> I.D. A huge clear yellow, very deep flower. A prize winner at many shows .....	2.50	
<b>Monmouth Champion.</b> F.D. A strong vigorous grower, producing extra large flowers of a brilliant orange-flame. Stems perfect .....	1.00	
<b>Milton J. Cross.</b> I.D. Very large flower, color clear gold at center shading to orange-buff on outer half of petals. A winner at all the leading shows. Flowers 10 to 11 inches	10.00	
<b>Monmouth Pennant.</b> I.D. A large bicolor, red and white..	2.50	
<b>Mrs. George Le Boutellier.</b> F.D. An outstanding variety. It won three Achievement Awards and best flower in the show when exhibited with 14-inch flowers on straight stiff stems. Color rich velvety carmine .....	3.00	
<b>Murphy's Masterpiece.</b> I.D. A monster bloom of dark red shading to garnet. The largest of its color .....	2.50	
<b>Myra Howard.</b> I.D. One of the most attractive plants with thrifty growth and plenty of huge flowers. Color pure gold with rose sheen .....	\$ 1.00	
<b>Nannie Sine.</b> F.D. A beautiful flower in cameo-pink with deep tones of tuline-pink. Dr. Howe says it runs neck and neck with Satan at the Botanical Gardens trials.....	1.00	
<b>Normandie.</b> I.D. Bright mallow-pink striped with silver. Flower 12 to 14 inches. One of the largest Dahlias .....	5.00	
<b>Omar Khayyam.</b> F.D. Scored high at Storrs. Color Chinese red at base of petals shading to bright orange .....	.75	
* <b>President Roosevelt.</b> F.D. A beautiful Chinese red on the best of stems. Wonderful for decorative purposes .....	2.50	
<b>Ruby Taylor.</b> I.D. A huge exhibition of deep carmine color, good habit and perfect stems .....	1.00	
* <b>Rockley Moon.</b> F.D. Bright yellow with bronze tints at the center. Fine cut flower .....	1.00	
<b>Sanhegan's Cameo.</b> F.D. A real beauty in coral-pink overlaid with gold sheen .....	1.00	
* <b>Shahrazad.</b> I.D. Soft rose color, with habit and growth similar to the Jane Cowl .....	1.00	
* <b>Snowwhite.</b> A pure white with good stem and flower .....	1.00	
<b>Star of Bethlehem.</b> I.D. Pure white flowers with pointed petals .....	1.00	
* <b>Sultan of Hillcrest.</b> F.D. A very large golden yellow with reverse of orange-yellow. Blooms 12 inches, on strong stems. A wonderful producer of large blooms .....	1.00	
* <b>The Commodore.</b> I.D. A brilliant lemon-yellow, overlaid with golden sheen .....	.75	
<b>Thomas A. Edison.</b> F.D. A gorgeous royal purple with a sheen of velvet ..	1.00	
* <b>Treasure Island.</b> F.D. One of the brightest autumn shade Dahlias. Color bright apricot with old gold and rose-suffusions .....	.75	
* <b>Watchung Chief.</b> F.D. A combination of autumn shades ....	1.00	
* <b>Watchung Sunset.</b> F. D. A large flower of deep shade of old rose .....	1.00	
<b>Wenoka.</b> F.D. A huge flower of rosy mauve and deep magenta on long stiff stems. An ideal grower and free from insect attacks .....	3.50	
<b>White Wonder.</b> I.D. A giant white which is hard to beat ..	1.00	
<b>Yankee Gold.</b> I.D. A huge flower of bright gold, deepening towards the center .....	1.00	
<b>Yankee Royal.</b> I.D. One of the largest exhibition varieties of bright purple .....	1.00	
* <b>Yellow King.</b> F.D. A lemon-yellow cut flower variety ....	1.00	

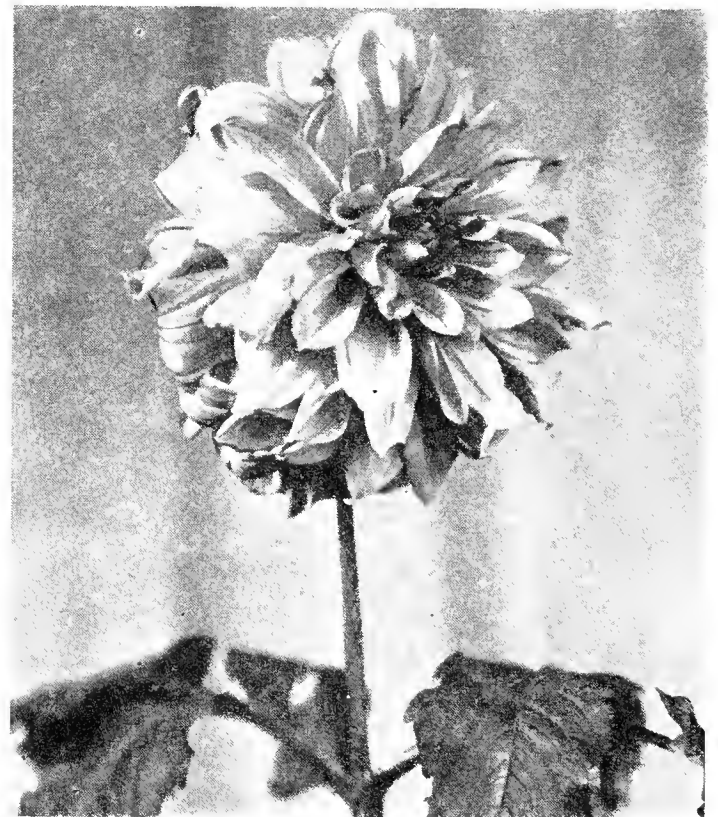

Chemar's Curly Locks

MARSHALL'S MATCHLESS DAHLIAS—Continued

DECORATIVE DAHLIAS

The following are selected as being some of the best of the popular varieties.

Our large stock of these enable us to offer all at popular prices. Varieties marked thus (\*) are most suitable for cutting.

*Atlantic City. F.D. Bright gold. Fine for cutting.....	Each \$ 0.50
*Avonelle. F.D. Very dark violet. Long stems.....	.50
*Avalan. F. D. Pure canary-yellow .....	.50
Barbara Redfern. I.D. Old rose and gold .....	.50
*Chas. Stratton. I.D. Amber and rose .....	.25
*Clara Fisher. F.D. Golden yellow with rose suffusion .....	.25
*Dr. John Carman. F.D. Tyrian rose tipped with silver .....	.50
*El Toreador. F.D. A glowing crimson on good stem .....	.50
Elkridge. I.D. A 10-inch, pure white on a long stiff stem ..	.50
*Francis Larocca. F.D. A large yellow on a 3-foot stem ....	.25
Harry Mayer. F.D. A beautiful silvery pink, with a deep rose pink on reverse petals .....	.50
Ida Perkins. F.D. A fine white for exhibition or cut flower..	.50
*Jane Cowl. I.D. A warm buff and old gold .....	.25
*Jersey's Beacon. A Chinese scarlet .....	.25
*Jersey's Beauty. F.D. A real rose-pink .....	.25
Jersey's Mammoth. One of the largest Dahlias in bronze color	.75
Judge Leon McCard. F.D. Deep gold .....	.50
*Kathleen Norris. I.D. True rose-pink, deepening later to mallow-pink with central petals a lighter shade .....	.50
*Manetto Glary. F.D. Amber with pink shadings. Very free flowering .....	.50
*Margaret Woodrow Wilson. I.D. Creamy white, suffused pink, reflex darker .....	.25
Marmion. I.D. Yellow with bronze suffusion .....	.50
*Mrs. Alf. B. Seal. I.D. A pure, rich glowing old rose without a trace of any other color .....	.50
*Mrs. I. De Ver Warner. F.D. A deep mauve-pink.....	.25
*Nathan Hale. F.D. The best of all the deep autumn shades. A beautifully formed flower with a coppery pink center shading to gold at the tips. ....	.50
*Nellie Austin. I.D. A free flowering peach-red suffused gold	.50
*Orange Beauty (Chemar's). F.D. A wonderful salmon-orange	.50
Queen of the Garden Beautiful. F.D. Primrose-yellow .....	.50
*Roman Eagle. F.D. Roman gold .....	.25
*Sagamore. F.D. Amber-gold, shaded salmon-rose and orange-buff .....	.25
Salmon Supreme. F.D. Salmon-pink .....	.50
*The World. F.D. Deep rosy magenta with silver shadings..	.50
*White King. F.D. A pure white cut flower variety .....	.50
*Yankee King. I.D. Intense flame with rose reverse. Large flower .....	.25
*Yark and Lancaster. F.D. A bright crimson, sometimes tipped white .....	.50

On varieties priced at 25 cents, add 5 cents each for postage.

CACTUS DAHLIAS

The following varieties comprise the cream of the novelties which have proved to be of extra merit.

The incurved varieties are marked I.C.; Recurved or straight varieties, R.C.; Fully double varieties, S.C.

Varieties marked with an asterisk(\*) are most suitable for cutting.

Ambassador. R.C. Soft yellow shaded salmon-pink.....	Each \$ 1.00
*American Triumph. I.C. A bright shade of oriental red. Flowers deep and good substance.....	1.00
Amelia Earhart. S.C. This gorgeous Dahlia was a consistent winner wherever shown. Color is apricot-buff with salmon tints, shading to soft yellow at the base of the petals. Blooms, 12x16 inches. Plants .....	2.00
*Challenger. S.C. A brilliant cardinal red with gold at the base of the petals. Wonderful keeper and decorative variety .....	3.00
Chemar's Masterpiece. I.C. A beautiful orchid-pink.....	.25
Edna Ferber. S.C. The extreme size and beauty of this flower attract attention wherever shown. The petals are curled and twisted, forming an extremely full flower. Color glistening coral, shading to old gold at base of petals .....	1.00
Frau. O. Bracht. S.C. A clear pale primrose of distinctive form .....	1.00
Gold Standard. S.C. A 12 inch flower on a 3 foot stem. Won Achievement Medal in 1934. A warm buff shaded amber and gold .....	3.00
Jean Trimbee. S.C. Massive artistic flower of a beautiful Petunia-violet color .....	3.00
*Kiss Me. S.C. A red and white flower. Fine for cutting ....	.50
*Marshall's Gem. I.C. Similar to the Grizzly but never shows open center .....	2.00
*Marshall's Golden Beauty. S.C. An outstanding bright gold A wonderful keeper .....	2.00
*Marshall's Silverada. S.C. A beautiful silver-pink with curled petals. Fine for decorations .....	2.50
Renate Mueller. I.C. Bright salmon-rose with pale yellow center .....	1.00
*Rudy Vallee. S.C. Color reddish apricot, gold center. Large size and long straight stems .....	.75
Robert E. Lee. I.C. Cardinal-red .....	.50
Satan. S.C. Color, scarlet with yellow on reverse of petals. Very long stems, plants tall and rugged. Large flowers ..	2.00
Siskiyou. R.C. Pink tinged mauve .....	1.50
The Grizzly. R.C. Dark velvety maroon .....	.50
Wemco White. S.C. A free blooming pure white of fine form and growth. Insect proof .....	3.00



Miniature Cactus, Princess Royal

MINIATURE CACTUS DAHLIAS

These are the small flowering true cactus type. They are very dainty for decorations and profuse bloomers.

Baby Royal. I. C. Flowers soft pink and apricot on long stems .....	Each \$ 0.75
Cardinal Gem. Rich cardinal-red. Stiff stems; good for cutting .....	.75
Elizabeth Pape. A bright rose-pink with amber suffusion. A distinct Cactus form .....	.50
Little Louie. Rose-pink. Very tiny with spiky petals .....	.75
Mauve Pearl. A beautiful mauve or lavender shade .....	.50
Princess Royal. A great improvement over Baby Royal. The flowers are incurved with full centers, color pink and apricot. Dwarf habit, plants only growing 18 to 24 inches tall which are covered with beautiful miniature flowers through the season .....	2.00
Rabin. A very tiny fine petaled cactus in bright scarlet ....	.50
Snowdrift. A pure white of true cactus form with spiky petals .....	.75
Sweetheart. One of the daintiest. Color pale apricot suffused with shrimp-pink .....	.75

ROSETTE DAHLIAS

MINIATURE DECORATIVE DAHLIAS

Baby Gem. Rose-pink, with a 3-inch flower .....	Each \$ 1.00
Bobby. A very small flower. Light orange with darker base..	.50
Fairy. Violet-rose shading to mauve at tips .....	.50
Gardenia. A beautiful pure white .....	.75
Gaod Luck. Very distinctive and most attractive in orange color .....	.50
Irene. Exquisite old rose .....	.50
Ladybird. A very distinctive clear pink with gold shadings ..	.75
Lady Mary Hape. Amber and orange tipped white .....	.50
Marshall's Gem. A perfect 2-inch flower, color salmon-pink..	1.00
Peach Blossom. A lovely peach color .....	.75
Red Sea. A bright red on a good stem .....	.50
Rhoda. A glowing orange and rose-pink .....	.50
Sparklet. Small, very double with pointed petals. Old rose cerise with crimson shadings to rose at tips .....	.75
Teddy Johnson. Variegated rose and white .....	1.00
Wemco. Buff suffused pink, small flower .....	.50

COLLARETTE DAHLIAS

They are similar to large single Dahlias with a row of small petals around the central disc. Fine for decorative purposes.

Daon. Bright scarlet-gold collar ..	Each \$ 1.00
Giant of Fruitvale. Large velvety brownish red, white collar.	.50
Herald. Pinkish rose, white collar .....	.75
Maurice Rivaire. Crimson-maroon, white collar. Medium size.	.50

MARSHALL'S FINE DAHLIAS—Continued

POMPON DAHLIAS

The Pompon Dahlias are greatly in demand for table decorations and exhibition purposes.

Note. We have eliminated all varieties of a similar color and formation, also large size flowers and short stemmed varieties.

	Each
<b>Aimee.</b> A wee bronze gem, long stems	\$0.50
<b>Amber Queen.</b> Clear rich amber, shaded apricot	.35
<b>Anita.</b> Deep old rose.	
<b>Arthur.</b> Small brilliant scarlet.	
<b>Atom.</b> A wee flower of orange.	
<b>Belle of Springfield.</b> Crushed strawberry.	
<b>Bobby.</b> A rich plum color	.35
<b>Clara Elisabeth.</b> Extra fine. Deep scarlet.	
<b>Cora May.</b> Salmon-pink shading to light primrose-yellow with rose eye	.50
<b>Darkest of All.</b> Maroon colored black	.50
<b>Dee Dee.</b> Pale lilac. Fine for exhibition	.35
<b>Dimples.</b> Golden apricot, dark brown center.	
<b>Donny.</b> Small orange that holds its center	.50
<b>Edith Muller.</b> Golden-yellow, suffused rosy red.	
<b>George Ireland.</b> A beautiful shade of mauve.	
<b>Glow.</b> Light rose-pink or coral. Very pretty.	
<b>Haake's Glow.</b> Yellow base heavily tipped old rose	.50
<b>Helen Anita.</b> Lavender with white center.	
<b>Honey.</b> Light yellow with a faint suffusion or tint of orange petals. Long stems.	.75
<b>Joe Fette.</b> The best and smallest white.	
<b>Johnny.</b> A small flower in maroon.	
<b>Johnny Peppin.</b> Small dark crimson	.50
<b>Lassie.</b> Yellow base; old rose shadings.	
<b>Little Beeswing.</b> Golden base, tipped red.	
<b>Little David.</b> One of the smallest oranges.	
<b>Little Edith.</b> Bright gold, edged red.	
<b>Lolita.</b> Yellow, brown center.	
<b>Mary Munns.</b> Fuchsia with dark orchid sheen.	
<b>Midget.</b> Soft salmon, suffused violet.	
<b>Mike.</b> None smaller in burnt orange.	
<b>Myra.</b> Deep canary, heavily edged raspberry-red. Very distinct	.50
<b>Nankee Poo.</b> Golden-yellow with brown center	.50
<b>Nerissa.</b> A rich Cattleya or orchid-pink.	
<b>Peggy Ann.</b> Yellow shading to brownish red	.50
<b>Pixy.</b> Very small deep yellow, tipped Indian red.	
<b>Ruth Marshall.</b> Variegated red and white	.50
<b>Silver Tip.</b> Small purple center and edge of petals silvery gray.	.50
<b>Sunny Jim.</b> Pinkish tan. Long stems	.50
<b>Sunset.</b> Bright orange, one of the best.	
<b>Taka's Purple.</b> Light purple.	
<b>Tinny.</b> Light orange. Very small flower	.35
<b>Tom Thumb.</b> Dull scarlet.	
<b>Virginia Rute.</b> Light lavender, very small.	
<b>Vivid.</b> Brightest scarlet. Extra fine	.35
<b>White Aster.</b> A distinct white	.50
<b>Yellow Gem.</b> Pure yellow.	

Tubers of all varieties. Each 30c except where noted.

COLLECTION OF POMPON DAHLIAS

This collection is made up from varieties that sell for 30c to 75c each. Each variety is named and will include a range of all colors. Collection of 10 tubers for \$2.50. Postpaid.

ENGLISH CHARM DAHLIAS

Miniature Dahlias of Peony-flowered Type

The newest type from Europe. They form bushy plants, 2 1/2 to 3 1/2 feet in height and are literally covered with flowers all season. The medium sized, semi-double blooms are carried on rigid, wire-like stems well above the foliage, making ideal garden plants. As cut flowers they are superb, keeping fresh in water for many days.

	Each
<b>Nora Bell.</b> Orange-red, yellow base	\$0.50
<b>Pink Pearl.</b> A beautiful deep pink	.50
<b>Peach.</b> A most delightful soft pink shade with light yellow base. Extra free	.75
<b>Radiance.</b> An ideal variety as to habit. Freedom of bloom and stems are its strong points. A most pleasing scarlet shade with golden yellow base	.75
<b>Tiny.</b> One of the best of the newer Charms. Free flowering and rigid stems. Orange-amber tinted bronze	.75

SINGLE DAHLIAS

These have become very popular for cutting purposes. We list a few of the best varieties.

	Each
<b>Ami Barillet.</b> Brilliant scarlet, dark foliage	\$0.50
<b>Belle of Mexico.</b> Light buff, purple ring in center	.50
<b>Chelsea Beauty.</b> A fine bronze color, with dark foliage	.50
<b>Chelsea Gem.</b> Brilliant scarlet with dark foliage	.50
<b>Chelsea Jewel.</b> Very dark red flowers and foliage	.50
<b>Crowley Star.</b> Rose-pink. Pointed petals	.50
<b>Fuji San.</b> Bronze-yellow with crimson ring	.50
<b>Marshall's Fire Flame.</b> A brilliant flame on a long stem	.50
<b>Marshall's Gloria.</b> A pure white with each petal edged with bright rose. Fine for cutting	.50
<b>Marshall's Peach.</b> Peach-pink, center yellow surrounded a red disc. Fine for cutting	1.00
<b>Newport Triumph.</b> Bronze, shaded salmon-pink	.75
<b>Newport Wonder.</b> A beautiful rose-pink	.75
<b>Pequot Yellow.</b> Very large yellow. Extra free	1.50
<b>Queen of Whites.</b> An improved Newport Angel	1.00
<b>Splashed Gem.</b> White, splashed and streaked with rosy red; long stems, free flowering	.50
<b>Tango Century.</b> A very large bronze	.50
<b>White Star.</b> Pure white flowers about the size of a Casmas	.30
<b>Yellow Treasure.</b> Extra free flowering. Light yellow	1.00



Dahlia, Easter Greeting

NEW DWARF DAHLIA, EASTER GREETING

**Easter Greeting.** This new Dahlia can be grown in pots for Easter blooming and later planted in the garden where it will continue to bloom until frost. The plants are dwarf and compact, producing dainty creamy white flowers of Cactus form. Plants 75c, \$7.50 per doz.

SHOW OR BALL DAHLIAS

	Each
<b>Black Diamond.</b> Ruby red	\$0.50
<b>Caroline.</b> A perfect pink ball	.50
<b>Crown of Gold.</b> A large 8-inch ball in bright gold suffused red	1.00
<b>Pink Ball.</b> A bright pink	.50
<b>Patricia Armstrong.</b> A winner from coast to coast. An eight inch dark red flower on a long stem	1.50
<b>Red Champion.</b> Rose-red	.50
<b>Shirley Temple.</b> A perfect yellow ball	.50
<b>Supt. Amrhn.</b> Rose-pink	.25

STAR OR ORCHID DAHLIAS

These are popular for landscape, table decorations or vases. The bushes grow from 2 to 3 feet and are covered with blossoms 4 to 5 inches in diameter. Tubers in mixture. Each 30c, doz. \$3.00.

Collections of Dahlias

CUT FLOWER COLLECTION, \$5.00

Varieties best for cutting and decorations.

- Golden Eclipse.** Clear golden yellow.
  - Jane Cowl.** I.D. Buff and old gold.
  - Jersey's Beauty.** F.D. A real rose-pink.
  - Kiss Me.** S.C. Red and white.
  - Marshall's Pink.** F.D. Baby Pink.
  - Orange Beauty.** F.D. Salmon-orange.
  - Marshall's Red Beauty.** F.D. Brightly velvety-red.
  - Mrs. A. E. Wheeler.** F.D. Fuchsia and magenta.
  - Nathan Hale.** F.D. Autumn shades.
  - Sagamore.** F.D. Amber-gold and rose.
  - White King.** F.D. Pure white.
  - Yellow King.** F.D. Lemon-yellow.
- One tuber of each, value \$7.00, for \$5.00.  
Two tubers of each for \$8.00 delivered.

POPULAR COLLECTION, \$5.00

- Harry Mayer.** F.D. Pink shades.
  - Kathleen Norris.** I.D. True rose-pink.
  - Ida Perkins.** F.D. A fine white.
  - Nannie Sine.** F.D. A beautiful pink.
  - Nathan Hale.** F.D. Deep autumn shades.
  - Orange Beauty.** F.D. Salmon-orange.
  - The Commodore.** I.D. Lemon-yellow.
  - The Grizzly.** R.C. Velvet maroon.
  - Thomas Edison.** F.D. Royal-purple.
  - Treasure Island.** F.D. Autumn shades.
  - White King.** F.D. Pure white.
  - Yellow King.** F.D. Lemon-yellow.
- One tuber of each, value \$7.50, for \$5.00.  
Two tubers of each for \$8.00 delivered.

# Marshall's Gladiolus

There are no other summer-flowering bulbs so satisfactory, needing so little attention and thriving so well in almost any ordinary soil as the Gladiolus. Set the bulbs from 3 to 6 inches apart in rows, or for mowing 6 inches apart, and about 4 inches deep.

Our selection has been made from many varieties and includes all those of exceptional merit and a wide range of colors.

## BLUE, LAVENDER AND PURPLE SHADES

	Doz.	100
<b>Ave Maria.</b> Large blue with small purple blotches. . . . .3 for 30c.	\$1.00	\$7.00
<b>Berty Snow.</b> Light lavender orchid color, giant blooms, tall and vigorous. . . . .3 for 25c.	.75	5.00
<b>Blue Admiral.</b> The best of the dark blues. Tall, strong grower, flowers well placed . . . . .3 for 60c.	2.00	15.00
<b>Blue Danube.</b> A beautiful amethyst blue with a darker blotch. Long spike. . . . .3 for 50c.	1.75	12.00
<b>Captain Boyntan.</b> Light lavender, blotched deeper in throat . . . . .3 for 25c.	.75	5.00
<b>Charles Dickens.</b> Purple violet, taller and more flowers on the stem than Anna Eberius . . . . .3 for 25c.	.75	5.00
<b>Dr. Moody.</b> Early flowering, light lavender without markings. Strong grower. . . . .3 for 25c.	.75	5.00
<b>Fair Columbian.</b> Pure lilac, shaded deeper at the center. Tall, strong stems . . . . .3 for 30c.	1.00	6.00
<b>Heavenly Blue.</b> A large, clear, delicate lavender blue truly a gorgeous color . . . . .3 for 40c.	1.25	8.00
<b>La Troubadour.</b> Deep violet. Large flowers and a very tall grower . . . . .3 for 40c.	1.25	8.00
<b>Louise.</b> Orchid-lavender with deeper blotch in throat. Wide open flower on strong stem. . . . .3 for 25c.	.75	5.00
<b>Marmora.</b> Lavender to lavender-gray with a petunia colored blotch. One of the best. . . . .3 for 25c.	.75	5.00
<b>Minuet.</b> A self colored light lavender, rich, very large flower of heavy substance. . . . .3 for 35c.	1.25	8.00
<b>Morocco.</b> Deep maroon. A much better variety than Persia . . . . .3 for 30c.	1.00	6.00
<b>Mother Machree.</b> A vinaceous lavender, overlaid with salmon-pink at edges. . . . .Each 20c.	1.75	10.00
<b>Mrs. Fred C. Peters.</b> Fine lilac-pink with purplish blotch in throat. Large flowers with long erect stems . . . . .3 for 25c.	.75	5.00
<b>Mrs. Van Kanyenburg.</b> A matchless aniline-blue. The best blue variety . . . . .3 for 25c.	.75	5.00
<b>Pelagrina.</b> Pure deep violet-blue. Fine for exhibition. . . . .3 for 50c.	1.75	10.00
<b>Purple Glory.</b> Velvet maroon. Large ruffled flowers, extra fine spike. . . . .3 for 30c.	1.00	6.00
<b>Veilchenblau.</b> Violet-blue flowers of large size. . . . .3 for 30c.	1.00	6.00

## PINK, ROSE AND SALMON SHADES

<b>Arlene.</b> A uniform, pale rose-pink, shading in the throat to a pale flesh-pink, with deep crimson base. A beautiful variety . . . . .3 for 20c.	.60	4.00
<b>Betty Co-Ed.</b> A pleasing combination of soft pink with deep cream throat . . . . .3 for 60c.	2.00	15.00
<b>Betty Nuthall.</b> A warm, light coral with pale orange throat and a light feathering of carmine. Tall, strong spike . . . . .3 for 20c.	.60	4.00
<b>Break of Day.</b> A very clear light pink. Early and tall spike . . . . .3 for 20c.	.60	4.00
<b>Cara Mia.</b> A very early delicate pink with light rose spot on lower petals . . . . .3 for 25c.	.75	5.00
<b>Carolus Clusis.</b> An early light pink. Tall spike. . . . .3 for 25c.	.75	5.00
<b>Catherine Coleman.</b> Rich coral La France pink. An exceedingly choice variety . . . . .3 for 30c.	1.00	6.00
<b>Coryphee.</b> Salmon flesh shades rose. A very refined pink. Fine form and many open. . . . .3 for 35c.	1.25	8.00
<b>Dearest.</b> A glorious flower of most delicate tints. The ground is a flesh pink blending to a rich pink at the tips, mottled and striped with crimson. Flowers ruffled . . . . .3 for 30c.	1.00	7.00
<b>Emile Aubrun.</b> A blend of rose and orange, with a slaty gray overtone. . . . .3 for 25c.	.75	5.00
<b>Frank J. McCay.</b> Pure deep pink. Large flowers on long strong stems . . . . .3 for 50c.	1.75	10.00
<b>Giant Nymph.</b> Light rose-pink color with creamy yellow throat . . . . .3 for 25c.	.60	4.00
<b>Gloriana.</b> A fine large salmon with yellow throat. . . . .3 for 25c.	.75	5.00
<b>Longfellow.</b> Entire flower of clear La France pink, prominent lighter mid-rib. A fine exhibition variety. . . . .3 for 25c.	.75	5.00
<b>Los Angeles.</b> A beautiful grenadine or orange tinted pink. Also called the "Cut and Come Agrain" as it often sends up new spikes after being cut. . . . .3 for 25c.	.60	4.00



Mammoth White

	Doz.	100
<b>Marshall's Matchless.</b> New. Color soft orange-pink shading to lemon-orange in the throat, which is slightly shaded orange at the base . . . . .3 for 50c.	\$1.75	\$12.00
<b>Marshall's Glorious.</b> New. Clear apricot-pink, cream throat with carmine streak at base. Six to eight very large flowers open at one time . . . . .3 for 50c.	1.75	12.00

**Mildred Louise.** Soft glowing orange-pink. Spike and flowers similar to Picardy though darker . . . Each 25c. 2.50 18.00

MARSHALL'S GLADIOLUS—Continued.

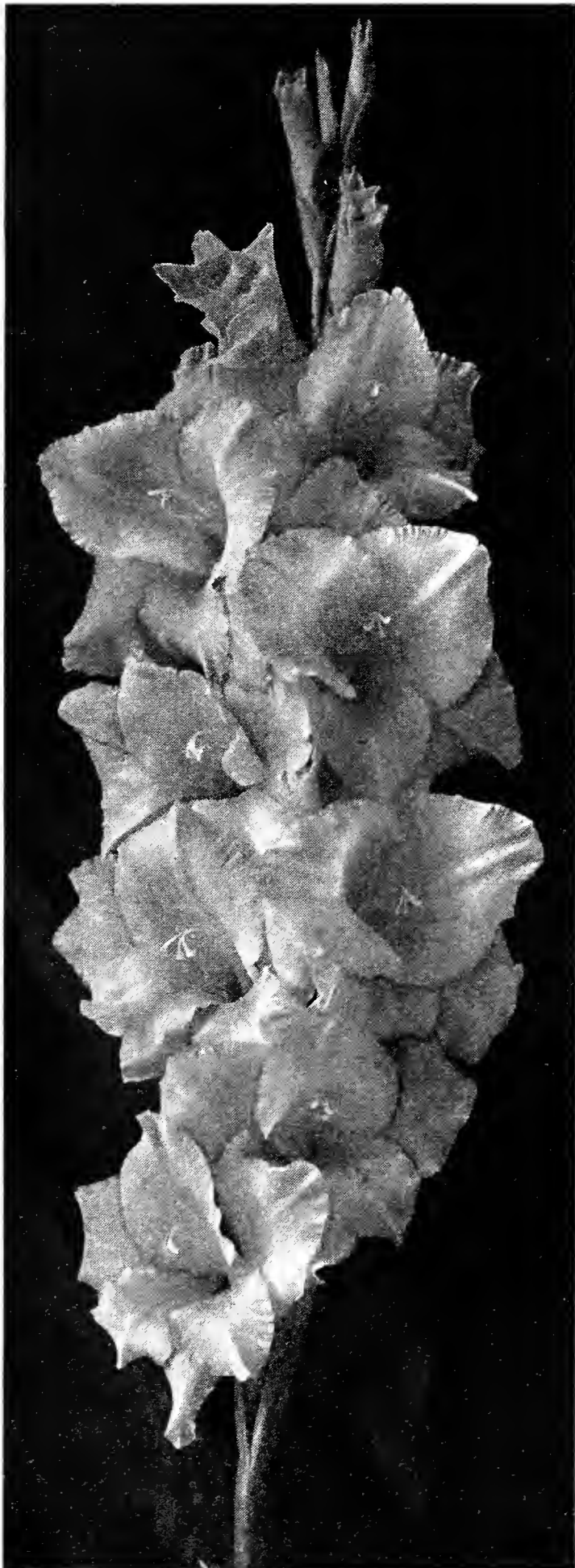

Picardy

PINK AND ROSE—Continued

	Doz.	100
Mrs. Frank Pendleton. The flowers are very large, of lovely flushed salmon-pink, with brilliant carmine blotches in the throat . . . . . 4 for 25c.	\$0.65	\$4.00
Mrs. Leon Douglas. Begonia rose striped with flame, lower petal pale lemon, speckled ruby. One of the largest glads in existence . . . . . 3 for 25c.	.75	5.00
Mrs. P. W. Sisson. A clear cameo-pink . . . . . 3 for 25c.	.75	5.00
Picardy. Soft apricot-pink. An excellent variety . . . . . 3 for 25c.	.75	5.00
Pink Wonder. A beautiful pink, slightly lighter than Panama . . . . . 3 for 25c.	.75	5.00
Pride of Wanaka. Lavender-rose, deeper at throat. . . . . 3 for 25c.	.75	5.00
Richard Diener. Very live rose-salmon with creamy yellow center. Spikes with 10 to 12 flowers open at one time . . . . . 3 for 30c.	1.00	6.00
Rasa Bella. An exhibition pink of a clear self color without a salmon shade . . . . . 3 for 35c.	1.25	8.00
Schwaben Girl. Clearest pure pink. Flowers closely set, many open. Long spikes . . . . . 3 for 50c.	1.75	12.00
Trudel Grotz. Glowing salmon-pink with small red blotch on throat. Enormous flowers . . . . . 3 for 35c.	1.25	8.00
W. H. Phipps. La France pink, overlaid with salmon-rose, lower petals faintly striped and speckled with ruby; enormous flowers and spike . . . . . 3 for 25c.	.75	5.00
Yvonne. White tinted pink with cerise markings on throat . . . . . 3 for 25c.	.75	5.00

RED, SCARLET, TYRIAN AND ORANGE SHADES

Aflame. Enormous red flowers on tall spike . . . 3 for 30c.	1.00	6.00
Bagdad. Smoky old rose, deeper in the edges and lighter in the throat. Perfect stems . . . . . 3 for 30c.	1.00	7.00
Bill Sowden. Immense flowers of deep blood-red . . . . . Each 20c.	1.75	10.00
Commander Koehl. Very large flowers on tall spike, color deep scarlet-blood-red . . . . . 3 for 35c.	1.25	8.00
Crimson Glow. A perfect scarlet of a deep tone on a tall spike . . . . . 4 for 25c.	.60	4.00
Dr. F. E. Bennett. The most fiery red imaginable. A monster in growth and vigor . . . . . 3 for 25c.	.75	5.00
Furnace. A beautiful salmon-orange, with a crimson-scarlet throat, mottled with orange-yellow . . . 3 for 30c.	1.00	6.00
Joerg's Favorite. A pale cream, feathered and splashed with bright crimson and bright orange throat. . . . . 3 for 35c.	1.25	8.00
Pfitzer's Triumph. A giant orange-salmon, blotched red on lower petals. . . . . 3 for 25c.	.75	5.00
Red Roy. Rich red with cream blotches. Tall spike. . . . . 3 for 35c.	1.25	8.00
Scarlano. A brilliant and most striking flower of rich orange-red. Beautifully ruffled . . . . . 3 for 25c.	.75	5.00
Scarlet Wonder. Purest deep scarlet, mammoth flowers on tall stiff stem . . . . . 3 for 25c.	.75	5.00
Virginia (Scarlet Princes). A very large spike of massive crimson-scarlet flowers. Five to six open at one time . . . . . 3 for 25c.	.65	4.00

WHITE, CREAM AND BLUSH SHADES

Albania. A fine pure white. Flowers well placed. . . . . 3 for 25c.	.60	4.00
Albatros. A beautiful pure white. . . . . 3 for 35c.	1.25	8.00
Carmen Sylva. Pure white with slight violet markings deep in the throat. . . . . 3 for 25c.	.75	5.00
Fern Kyle. A massive creamy white, large flowers slightly ruffled . . . . . 3 for 30c.	1.00	6.00
Joerg's White. This is one of the largest flowered Gladiolus and the finest and purest of all white varieties. Spikes 3 to 4 ft. high and flowers 5 in. across. . . . . 3 for 30c.	1.00	7.00
Maid of Orleans. Color milky white with light cream blotch on lower petals. One of the finest whites. . . . . 3 for 50c.	1.75	12.00
Mammoth White. Purest white. A real giant among the whites. Mammoth flowers and long stems. . . . . 3 for 35c.	1.25	8.00
Mary Pickford. A delicate creamy white. Throat finest sulphur yellow . . . . . 3 for 25c.	.75	5.00
Mrs. F. C. Hornberger. One of the finest whites. Strong sturdy spikes. Flowers ruffled . . . . . 3 for 30c.	1.00	6.00
Olive Goodrich. A good large white with pink edges. . . . . 3 for 25c.	.75	5.00
Star of Bethlehem. Snow-white with tinge of cream on the lower petals. Enormous flowers, perfectly placed on tall strong stems . . . . . Each \$1.00.	10.00	

YELLOW SHADES

Canberra. A tall spike of clear yellow flowers in the exhibition class . . . . . 3 for 35c.	1.25	8.00
Gate of Heaven. Large pure deep yellow heavily ruffled flowers on stiff strong stems . . . . . Each 30c.	3.00	20.00
Golden Dream. A pure golden yellow. A better and clearer yellow than Golden Measure. . . . . 3 for 25c.	.75	5.00
Gold Measure. A magnificent yellow. Very large open flowers; immense spike. . . . . 3 for 25c.	.75	5.00
Joerg's Yellow. A flower spike 5 ft. high, carrying 12 to 18 large pure yellow flowers. Flowers large and wide open . . . . . 3 for 25c.	.75	5.00
La Paloma. Tall, rich orange. Very large florets on straight spike. Good grower . . . . . 3 for 30c.	1.00	6.00
Loyalty. A large, ruffled deep golden yellow. Tall strong grower . . . . . 3 for 30c.	1.00	7.00
Primrose Princess. Very large clear primrose-yellow . . . . . 3 for 30c.	1.00	6.00



MARSHALL'S GLADIOLUS—Continued.

PRIMULINUS GLADIOLUS

This race of Gladiolus has come to be extremely popular; they are easy to grow, beautiful for decorations; the colors are very artistic and embrace shades of yellow, pink and scarlet.

	Doz.	100	
<b>Alice Tiplady.</b> A grand, large, beautiful orange-saffron color	4 for 25c.	\$0.60	\$4.00
<b>Apricot Glow.</b> A very fine, clear apricot color.	4 for 25c.	.60	4.00
<b>Darathy Wheeler.</b> Flowers richest rose-pink with lighter throat. Very large and massive.	3 for 25c.	.75	5.00
<b>Ethelyn.</b> A beautiful shade of orange-yellow, petals tipped with bronze. Throws many side spikes.	3 for 25c.	.75	5.00
<b>Golden Frills.</b> Deep golden yellow, with red markings in the throat. Heavily ruffled petals	3 for 25c.	.75	5.00
<b>Jewel.</b> A clear salmon-pink with golden throat. Tall, erect, early flowering.	3 for 25c.	.75	5.00
<b>Maiden's Blush.</b> Enchantress pink. Well-shaped flowers on long, strong stems.	4 for 25c.	.60	4.00

	Doz.	100
<b>Marshall's Triumph.</b> New. A delicate peach-blossom-pink with slight suffusion of darker shade on reverse of the petals. Flowers well spaced on long stems	3 for 50c.	\$1.75 \$12.00

<b>Ming Toy.</b> Tall, large, beautiful buff, yellow center.	3 for 25c.	\$0.75	\$5.00
<b>Orange Butterfly.</b> A glowing bronzy orange. Opens many flowers at once	3 for 30c.	1.00	7.00
<b>Orange Queen.</b> Large flowers, orange yellow, tinted apricot. A grand variety.	3 for 25c.	.75	5.00
<b>Phantasy.</b> A clear salmon-pink with coral margin, buds are brilliant orange-scarlet. The flower petals are pale yellow, edged pink, with crimson veined throat. The upper petal folds back. Early flowering.	3 for 25c.	.75	5.00
<b>Prim Picotee.</b> Red florets with a very distinct border of yellow. Long and narrow florets	3 for 30c.	1.00	7.00
<b>Salman Beauty.</b> Deep salmon with rich salmon-yellow throat	3 for 25c.	.75	5.00
<b>Scarlet Bedder.</b> Clear soft scarlet, without markings.	3 for 25c.	.75	5.00
<b>Souvenir.</b> A superb large flowering deep yellow.	4 for 25c.	.60	4.00
<b>The Orchid.</b> Long narrow petals, slightly notched and ruffled; color orchid over white with rose lilac feathering in the throat. Really a new type.	3 for 35c.	1.25	8.00
<b>White Butterfly.</b> A popular white with creamy white throat. Strong grower.	3 for 25c.	.75	5.00

PRIMULINUS HYBRIDS

A very select mixture from the newest hybrids; the most beautiful and delicate tints are found among them and no race of Gladiolus contains such harmonious blendings of color.

	Doz.	100	1000
<b>Selected Mixed Hybrids.</b>	\$0.60	\$4.00	\$35.00

We shall be pleased to supply any varieties not listed at advertised prices.

PASTEL SHADES

	Doz.	100
<b>Marshall's Pastel Shades.</b> A wonderful mixture of seedlings of Pastel Shades in the Super Primulinus types, with a magnificent range of colors.	3 for 35c.	\$1.25 \$8.00

GLADIOLUS IN MIXTURE

Our mixtures are made up from fine varieties and are all selected first size bulbs.

	Doz.	100	1000
<b>Marshall's Special Mixture.</b> This mixture is made up from named varieties and seedlings. They are splendid for cutting and borders	\$0.75	\$5.00	\$45.00

GLADIOLUS FOR LATE PLANTING

Gladiolus can be had in flower in late September and October if the bulbs are retarded in cold storage.

We are prepared to place in cold storage any varieties if ordered before the middle of April and ship at any date required for later planting.

**Gladiolus Thrips.** All bulbs we send out have been fumigated to kill this pest before shipping. For further treatment we recommend spraying with **Rotecide** or **Red Arrow Insecticide** and soil treatment with **To-na-cide**.

All Gladiolus we offer are **First Size Bulbs**  
6 bulbs sold at the dozen rate. 25 at the 100 rate.

**TO-NA-CIDE.** A new insecticide for controlling thrips on Gladiolus when growing. 5 lbs. \$1.75, 25 lbs. \$7.00.

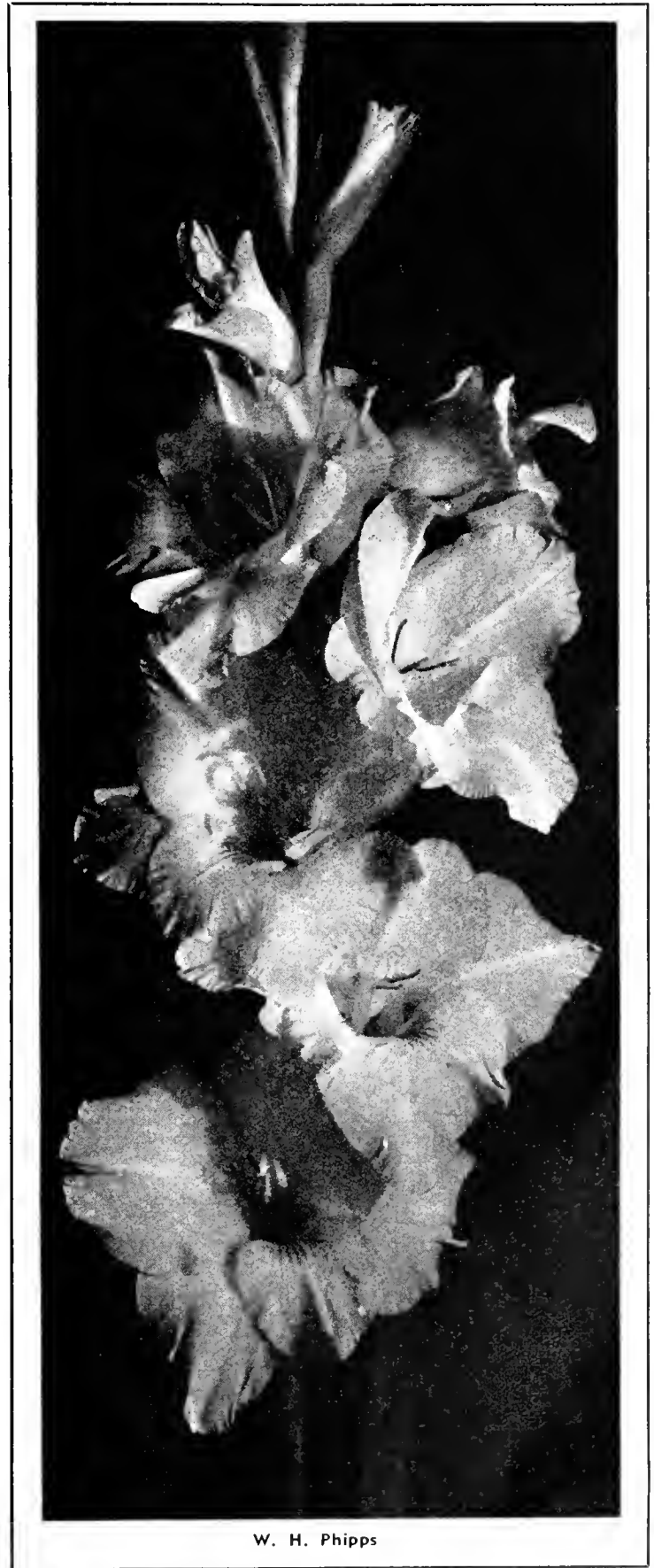

W. H. Phipps

SPECIAL NOTICE

All our Gladiolus bulbs are strictly first class and range in size from 1½ to 2½ inches in diameter. Some varieties do not make large bulbs, but we guarantee all we send out to produce first-class flowers.

HOLE-IN-ONE BULB PLANTER

A handy tool for planting Gladiolus and other bulbs. Makes a clean round hole any depth. A real time saver. Small size, each 50c. Large size with 30-in. handle, \$4.00.

# HARDY LILIES OF OUTSTANDING MERIT

## Lilium Maxwell

The Prize-Winning Lily

Over two years ago we placed this wonderful new lily before the public. After giving it a fair trial we had been convinced that it is one of the finest hybrid lilies of recent introduction. In fact since its introduction, this lily has not only maintained its reputation but has considerably enhanced it. In two or three years five and even six giant stems have been known to spring from one bulb originally planted. It is the only lily to receive the Cory Cup of The Royal Horticultural Society, for the best plant introduced in any one year, this award being only given to a plant of really outstanding merit.

Lilium Maxwell is a cross between L. Maximowiczii and L. Willmottiae, combining the free flowering qualities of the latter with the sturdiness and grace of the former parent. The color is a striking bright red, the stamens being orange-red. The numerous reflexed flowers have the habit of looking one straight in the face. Height 6 feet. Blooms late July.

PRICE: Strong flowering bulbs, \$1.00 each; 3 for \$2.75; \$10.00 per dozen.

## Lilium Philippinense Formosanum

(Lilium Formosanum)

We believe this to be one of the most satisfactory of all hardy white lilies. There are various types of this species, some being quite dwarf in habit and blooming in mid-summer. From the original tall, late flowering variety, discovered by E. H. Wilson in the island of Formosa, we have selected a very fine, pure white strain which we now offer.

The illustration opposite shows two plants standing 6 feet 9 inches high in front of W. E. Marshall who planted two bulbs the previous fall without any protection and were in full bloom the following September. Quite noticeable is the long grass-like foliage which extends almost to the long tubular shaped flowers. The fragrance is quite pleasing. Early spring planting is also quite satisfactory.

PRICE: Bulbs measuring 6 inches in diameter, 50c each; 3 for \$1.35; \$5.00 per doz; \$38.00 per 100.



Lilium Philippinense Formosanum

## Lilium Wardi

"The Pink Martagon Lily"

This beautiful lily was discovered by Capt. Kingdon Ward in one of his expeditions into Tibet. We procured a few seedlings and were the first to introduce it into this country and in compliment to this distinguished plant explorer we named it L. Wardi. The price at that time was almost prohibitive but we are now in possession of a large stock of flowering bulbs and are enabled to bring it within the reach of all.

As the illustration shows this lily produces many flowers on a stem which is covered with thick foliage. The flowers are much larger than L. martagon and have a beautiful pink shading, freely spotted purple. When well established the plants grow to a height of 4 feet and bloom in midsummer when a good pink lily is desired. Plant in partial shade in a well drained soil with a good proportion of well rotted leaf mould.

Prices on good flowering bulbs, \$1.50 each; 3 for \$4.00, \$15.00 per dozen.

### "Consider the Lilies"

In presenting this treatise, Mr. W. E. Marshall, the author, was prompted by a desire to assist the amateur but his wishes have gone beyond his expectations as his brochure is now recognized by experts as a text book on this interesting genus.

Over one hundred varieties are described with complete history and cultural directions. A most interesting book to read, illuminated with 67 magnificent colored plates.

There is only a limited supply of this book which will be sent postpaid for \$2.00. It also may be procured free with a cash purchase of Lily bulbs amounting to ten dollars.

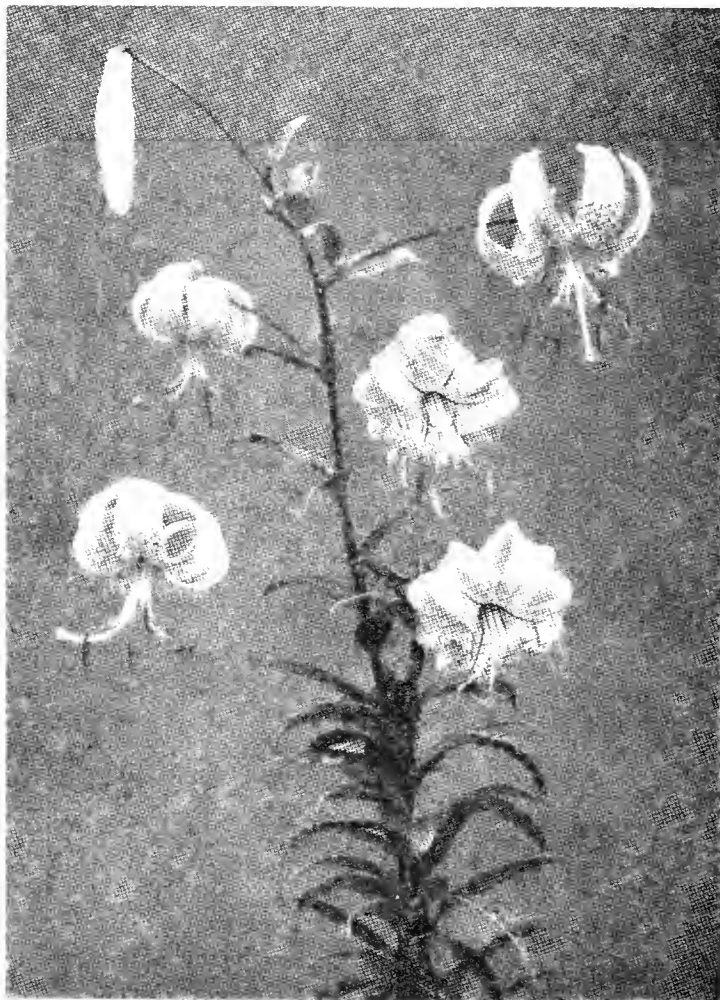
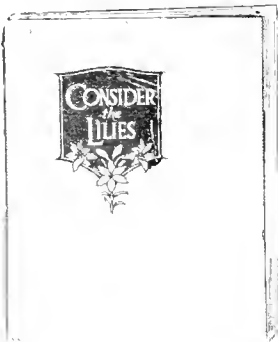

Lilium Wardi

# HARDY GARDEN LILIES

The herbaceous border is the ideal place in your garden for hardy Lilies. A few bulbs dotted here and there, where the close companionship and friendly shade of neighboring plants help their growth, they eventually become great colorful colonies, enhancing the entire beauty of the border with their graceful, dignified, and majestic heads.

If bulbs are planted just as soon as the ground is in condition in spring, one may expect excellent results the first season. We are in position to supply dormant bulbs as early as required. Order early and look for good results.

## LILIES FOR SPRING PLANTING

	Size	Each	For 3	Doz.	100
<b>Amabile.</b> Grenadin red; spotted black.....	3-4	\$0.50	\$ 1.35	\$ 5.00	\$35.00
<b>Auratum platyphyllum.</b> Golden banded lily of Japan.....	8-9	.45	1.25	4.50	32.00
<b>Auratum platyphyllum.</b> Golden banded lily of Japan.....	9-11	.75	2.00	7.50	58.00
<b>Auratum platyphyllum.</b> Golden banded lily of Japan.....	11-13	1.00	2.75	10.00	75.00
<b>Auratum platyphyllum rubro-vittatum.</b> With red bands.....	5-6	3.50	10.00	35.00	
<b>Auratum "Crimson Queen".</b> A rare and beautiful hybrid with broad, crimson bands.....	6-8	5.00	14.00	50.00	
<b>Auratum pictum.</b> Crimson spots and petal tips.....	10-11	1.00	2.75	10.00	75.00
<b>Browni.</b> Creamy white inside; rich purple outside; true English grown type.....	7-8	1.00	2.75	10.00	75.00
<b>Batemanniae.</b> Many apricot colored flowers on a stem.....	6-8	.50	1.30	5.00	35.00
<b>Cernuum.</b> A deep lilac-pink, spotted wine color.....	3-4	.40	1.10	4.00	30.00
<b>Chinooki.</b> The Sunset Lily ( <i>Pardalinum giganteum</i> ). Red and yellow.....	7-9	.75	2.00	7.50	60.00
<b>Cordifolium.</b> Resembles <i>L. giganteum himalaicum</i> , only smaller.....	4-6	.75	2.00	7.50	58.00
<b>Croceum.</b> (The Orange Lily). Flowers orange color.....	6-8	.50	1.35	5.00	38.00
<b>Croceum.</b> (The Orange Lily). Flowers orange color.....	9-11	.75	2.00	7.50	58.00
<b>Elegans, Alice Wilson.</b> Lemon-yellow, darker in center.....	3-5	.40	1.10	4.00	30.00
<b>Elegans, atrosanguineum.</b> Velvety crimson.....	3-5	.25	.70	2.50	18.00
<b>Elegans, Mahony.</b> A new variety. Intense rich maroon, suffused mahogany.....	3-5	.50	1.35	5.00	38.00
<b>Elegans, Prince of Orange.</b> Luminous, intense orange.....	3-5	.25	.70	2.50	18.00
<b>Elegans, Peter Barr.</b> An immense flower of purest yellow.....	3-5	.50	1.35	5.00	38.00
<b>Elegans, Mixed.</b> A splendid mixture of fine colors.....	3-5	.60	1.60	5.00	38.00
<b>Henryi.</b> The yellow speciosum. Bright orange-yellow.....	8-9	.50	1.35	5.00	35.00
<b>Henryi.</b> The yellow speciosum. Bright orange-yellow.....	9-11	.75	2.00	7.50	58.00
<b>Henryi.</b> The yellow speciosum. Bright orange-yellow.....	11-13	1.00	2.75	10.00	75.00
<b>Japonicum (Krameri).</b> Soft pink flowers, fragrant.....	7-9	.40	1.10	4.00	30.00
<b>Maxwill (New Hybrid).</b> See page 62.					
<b>Nepalense (Ochraceum.)</b> Greenish gold with vinous purple center.....	12-14	2.00	5.50	20.00	
<b>Pardalinum giganteum.</b> (See Chinooki.)					
<b>Philippinense formosanum.</b> White with reddish brown exterior.....	4-6	.40	1.10	4.00	30.00
<b>Philippinense formosanum.</b> The tall, late flowering, pure white type.....	6-7	.50	1.35	5.00	38.00
<b>Regale.</b> White shading to brown and pink; yellow throat.....	7-9	.35	.90	3.25	24.00
<b>Regale.</b> White shading to brown and pink; yellow throat.....	9-10	.60	1.65	6.00	45.00
<b>Regale.</b> White shading to brown and pink; yellow throat.....	10-12	1.00	2.75	10.00	75.00
<b>Regale.</b> White shading to brown and pink; yellow throat.....	12-14	1.25	3.50	12.00	90.00
<b>Sargentiae.</b> Milk white flowers with yellow throat.....	4-6	1.25	3.50	12.00	90.00
<b>Speciosum album.</b> Beautiful pure white flowers large size.....	8-9	.50	1.40	5.00	35.00
<b>Speciosum album.</b> Large bulbs.....	9-11	.65	1.75	6.50	50.00
<b>Speciosum rubrum magnificentum.</b> White, shaded and spotted rose.....	8-9	.30	.80	3.00	20.00
<b>Speciosum rubrum magnificentum</b> .....	9-11	.40	1.10	4.00	30.00
<b>Speciosum rubrum magnificentum</b> .....	11-13	.70	1.90	7.00	50.00
<b>Speciosum rubrum magnificentum</b> .....	13-15	1.10	3.00	11.00	85.00
<b>Speciosum rubrum Melpomene.</b> Darker than Magnificum.....	8-9	.35	.95	3.50	25.00
<b>Speciosum rubrum Melpomene</b> .....	9-11	.45	1.25	4.50	32.00
<b>Speciosum rubrum Melpomene</b> .....	11-13	.75	2.00	7.50	55.00
<b>Speciosum rubrum Melpomene</b> .....	13-15	1.20	3.25	12.00	90.00
<b>Sulphureum.</b> Immense trumpet-shaped flowers of sulphur-yellow shade. Outside faintly streaked cloret-red.....	12-14	2.00	5.50	20.00	
<b>Sulphureum.</b> .....	14-16	2.50	6.75	25.00	
<b>Sulphureum.</b> .....	16-18	3.00	8.00	30.00	
<b>Tigrinum flore pleno</b> (Double Tiger Lily).....	5-6	.30	.80	3.00	22.00
<b>Tigrinum Fortunei.</b> A superior type of the tiger lily. September.....	8-9	.40	1.10	4.00	30.00
<b>Tigrinum splendens</b> (Single Tiger Lily).....	6-8	.25	.65	2.50	18.00
<b>Tigrinum splendens</b> .....	9-11	.40	1.10	4.00	30.00
<b>Umbellatum erectum.</b> A splendid form. Rich red.....	7-9	.25	.65	2.50	18.00
<b>Umbellatum grandiflorum.</b> Orange-red; very fine.....	7-9	.25	.65	2.50	18.00
<b>Wardii.</b> (See page 62.)					

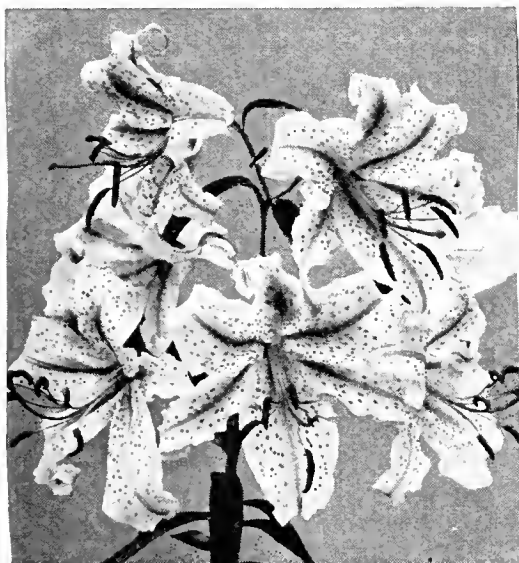

Lilium Auratum Platyphyllum

## COLD STORAGE LILIES

### FOR GREENHOUSE FORCING

We have in Cold Storage bulbs of the following Lilies available for shipment during the summer for late planting or greenhouse forcing.

**LILIAM FORMOSUM (The Erabu, Black Stemmed Variety).** We consider this variety most suitable for forcing into bloom in the early fall, as these bulbs keep in excellent condition until about July 1st.

Bulbs, 10-12 in. circum., .....25 for \$11.00, 100 \$40.00

**LILIAM LONGIFLORUM GIGANTEUM.**

Bulbs, 8-10 in. circum. ....25 for \$8.00, 100 \$30.00

Bulbs, 10-12 in. circum. ....25 for \$11.00, 100 \$40.00

**LILIAM REGALE.**

Bulbs, 9-10 in. circum., .....25 for \$12.00, 100 \$45.00

Bulbs, 10-12 in. circum., .....25 for \$20.00, 100 \$75.00

Bulbs, 12-14 in. circum. ....25 for \$25.00, 100 \$90.00

**LILIAM SPECIOSUM (Rubrum magnificentum or Melpomene).**

The favorite Lily for forcing into bloom for Christmas and during the winter months.

Bulbs, 11-13 in. circum., .....25 for \$17.00, 100 \$60.00

Bulbs, 13-15 in. circum., .....25 for \$25.00, 100 \$95.00

Not less than 25 sold. 50 at the 100 rate.

**LILIAM SULPHUREUM.** We have experimented with this beautiful Lily and find it is an excellent variety for cold storage and bringing into flower in the winter months.

Bulbs (See prices above.)

**LILIAM TIGRINUM.** This Lily is valuable for forcing and cold storage bulbs are very satisfactory.

Bulbs, 10 to 12 inches .....25 for \$10.00, 100 \$35.00

**LILY-OF-THE-VALLEY PIPS From Cold Storage.** We have in storage a large quantity of Dresden Pips for forcing at any season of the year. Lily-of-the-Valley can be forced in about four weeks from cold storage pips. We cannot supply less than 250.

Marshall's Matchless Pips. Case of 250 for .....\$20.00

# Greenhouse Plants

## ANTIRRHINUM (Snapdragon)

One of the most widely grown plants for greenhouse flowering and outside bedding.

- Afterglow.** The finest bronze.
- Claudespy.** A new white seedling of Cheviot Maid.
- Bertha Baur.** A new lavender orchid color.
- Cheviot Maid Supreme.** The best pink.
- Ceylon Court.** A beautiful yellow.
- Judd's Early Dark Pink.** A beautiful rose-pink, similar to the Premier Rose.

**Judd's Early Light Pink.** A magnificent pink, similar to the Columbia Rose.

- Roman Gold.** Golden bronze.
- Rose Queen.** Large flowering, new dark pink.
- Terry's Surprise.** A beautiful bronzy pink.
- Velvet Beauty.** Dark American Beauty red.
- White Rock.** Best forcing white.
- Winter Helen.** An improved Helen. Salmon-rose.

Plants of any of the above in season, 2 1/4-in. pots: 25 for \$3.50; 100, \$12.00.

Not less than 25 of a variety sold.

Varieties not listed can be supplied at current prices.

## Carnations

### Recent Introductions and Choice Varieties

	25	100
<b>Ditchling.</b> English variety, dark pink	\$10.00	\$35.00
<b>Giant Laddie.</b> Deeper pink than Laddie	7.50	25.00
<b>Golden Wonder.</b> Yellow variegated	6.00	20.00
<b>Laddie.</b> A warm salmon-pink	6.00	20.00
<b>Maine Sunshine.</b> The best clear yellow	5.00	16.00
<b>My Love.</b> Pink, with a silvery sheen	5.00	16.00

	25	100
<b>Patrician.</b> Large, white, vigorous	\$2.00	\$14.00
<b>Robert Allwood.</b> English variety. Scarlet	6.00	20.00
<b>Scarlet Monarch.</b> Scarlet, good keeper	5.00	16.00
<b>Virginia.</b> Salmon-pink	5.00	16.00
<b>Wivelstfield Claret.</b> Improved English variety	6.00	20.00
<b>Woburn.</b> Very deep crimson	5.00	16.00

Above prices are for rooted cuttings.

## General List of Greenhouse Plants

	2 1/4-in. pots		3-in. pots	
	25	100	25	100
<b>ADIANTUM gloriosum.</b> The hardiest Maidenhair	Doz. \$10.00			
<b>ASPARAGUS plumosus nanus.</b> Graceful, climbing Asparagus; beautiful, feathery foliage	\$4.00	\$15.00	\$7.00	\$25.00
<b>sprengeri.</b> Fine for baskets	4.00	15.00	7.00	25.00
<b>BEGONIA, Glory of Cincinnati.</b> A beautiful shade of pink	14.00	50.00	20.00	75.00
<b>Gustav Knaake.</b> Resembles Lorraine. Color crimson; wonderful for Christmas	6.00	20.00		
<b>Melior.</b> A more vigorous type of Lorraine	14.00	50.00	20.00	75.00
<b>Mrs. J. A. Peterson.</b> Deep pink flowers with red foliage	14.00	50.00	20.00	75.00
<b>Rex Varieties.</b> An assortment of types	10.00	30.00		
<b>Winter Flowering.</b> Hybrid type vars. Each \$2.50; doz. \$25.00				
<b>BOUGAINVILLEA sanderiana.</b> A free flowering Easter plant			9.00	30.00
<b>BOUVARDIA.</b> Single pink or white	6.00	20.00		
<b>BUDDLEIA asiatica.</b> White	6.00	20.00		
<b>Farquhari.</b> Pale pink	7.00	25.00		
<b>CALCEOLARIA, Mixed hybrida grandiflora</b>	8.00	25.00		
<b>lymani.</b> Cinnamon-red	14.00	50.00		
<b>medfordi.</b> Velvety maroon	14.00	50.00		
<b>stewarti.</b> A bright yellow variety	14.00	50.00		
<b>CALENDULA, Orange King, Ball's Gold or Sensation</b>	3.50	12.00		
<b>CHRYSANTHEMUMS.</b> Standard varieties to name	4.50	15.00		
<b>Standard Exhibition Varieties</b>	8.00	25.00		
<b>CINERARIA, Marshall's Half Dwarf Hybrids</b>	5.00	15.00		
<b>CYCLAMEN, Mixed.</b> Binnewies strain	6.00	15.00	14.00	50.00
<b>EUPHORBIA jacquiniaeflora.</b> A Christmas plant	10.00	35.00		
<b>FUCHSIA, Giant Pink.</b> Large pink and white flowers. A wonderful pot plant	5.00	16.00		
<b>Pride of Orion.</b> A strong upright grower with double white flowers	5.00	16.00		
<b>GARDENIA veitchi</b> (Cape Jasmine)	10.00	35.00	25.00	80.00
<b>GERBERA Jamesoni Hybrids.</b> Field clumps. Doz., \$7.50; 100, 50.00				
<b>MARGUERITE, Boston Yellow Daisy</b>	4.00	14.00		
<b>Mother's Favorite.</b> Double white	4.00	15.00		
<b>MYOSOTIS, Matchless.</b> A true winter flowering variety	10.00	30.00		
<b>PELARGONIUM, Easter Greeting,</b> Red with black blotch. Doz. \$4.50				30.00
<b>Gardener's Joy.</b> Pink with brown blotch. Doz. \$4.50				30.00
<b>Springtime.</b> Bright pink, white throat. One of the best. Doz. \$4.50				30.00
<b>POINSETTIA, Oak Leaf.</b> An improved variety which does not drop its lower leaves	6.00	22.50		

	2 1/4-in. pots		3-in. pots	
	25	100	25	100
<b>PRIMULA obconica grandiflora.</b> Mueller & Mohnstein strain	5.00	15.00		
<b>malacoides, American Legion.</b> Large clear pink, yellow center	4.00	12.00		
<b>malacoides, Superba.</b> Delicate lilac. Free flowering	4.00	15.00		
<b>—Ielandi.</b> A beautiful lilac-pink with large yellow eye. Long, stiff stems for cutting	6.00	20.00		
<b>—Radio.</b> Giant flowering, fringed, clear rose	5.00	15.00		
<b>sinensis.</b> Mixed colors	5.00	14.00	8.00	25.00
<b>SMILAX.</b> A popular greenhouse climber	5.00	12.00		
<b>SOLANUM, Cleveland Red.</b> An improved Jerusalem Cherry	5.00	14.00		
<b>STEVIA serrata.</b> Dwarf or tall	5.00	15.00		
<b>TABLE FERNS.</b> In variety. For fern dishes and ferneries	2.50	15.00		
<b>VIOLETS.</b> See our Fall catalogue.				

Orders for any of the above plants will be shipped in their season of delivery. Prices subject to change.

Not less than 25 of a variety supplied. We do not pay transportation charges on plants.

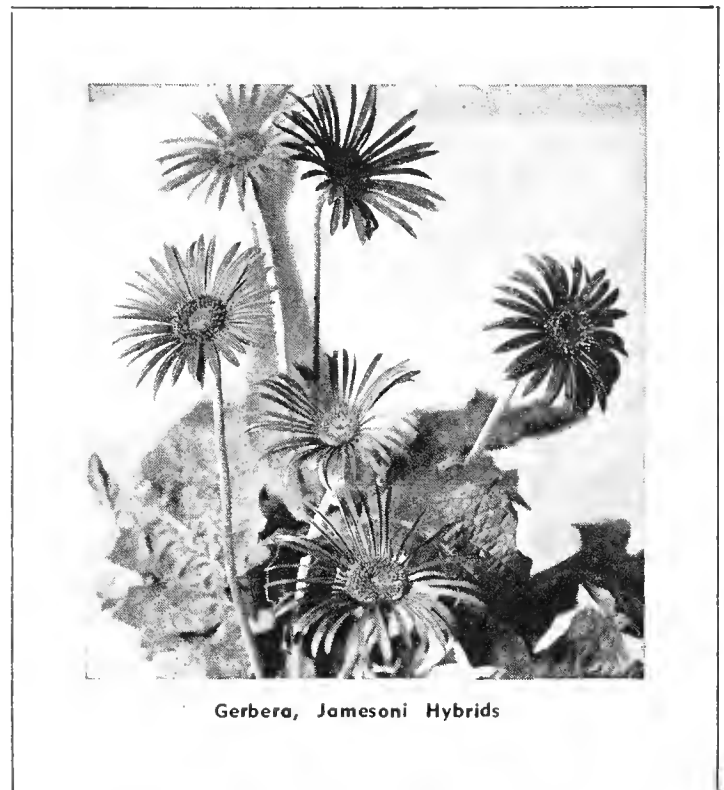

Gerbera, Jamesoni Hybrids

**HYDRANGEAS**

**YOUNG STOCK FOR GROWING ON**

The best of the standard varieties as well as those of more recent introduction are included in the following list.

- Henri Lambert.** Light pink.
- Marechal Foch.** Deep carmine-red.
- Mme. E. Maillere.** Best white.
- Otaksa.** The old reliable pink variety.
- Ami Pasquier.** Deep red, \$3.00 doz.; \$20.00 per 100.
- Clouet Hamel.** Deep pink, \$3.00 doz.; \$20.00 per 100.
- Gertrude Glahn.** Most popular pink.
- Helge.** Early red.
- Traphee.** Deep carmine-rose.

Prices of above (except where otherwise noted), \$2.50 doz.; \$18.00 per 100.

**WATER LILIES**

We are pleased to announce that we are again in a position to offer large plants of water lilies. These large plants insure a longer blooming period, many of them bearing developed flower buds when shipped. We stress the fact that these are large roots and are packed and shipped in sphagnum moss.

**TROPICAL DAY BLOOMING WATER LILIES**

Garden lovers are fast becoming acquainted with the superiority of the Tropical Water Lily over the old time Hardy Water Lily. The fragrant tropical blooms, with their great variety in color and shade, are larger and much more numerous than any of the Hardy varieties. Their long stiff stems not only add to their beauty in the pool, but make excellent cut flowers.

- |  |      |        |
|--|------|--------|
| <b>Amethyst.</b> Lovely amethyst blue, for tub or large pools, new                                       | Each | \$3.50 |
| <b>August Koch.</b> Most satisfactory bluish lilac, fragrant, prolific                                   |      |        |
| <b>Blue Bird.</b> Large, full petaled, cup shaped  | 2.25 |        |
| <b>Blue Triumph.</b> Immense deep blue flowers   | 3.50 |        |
| <b>Blue Zanzibariensis.</b> True blue, large star shaped, prolific                                       | 2.00 |        |
| <b>Dauben.</b> Light blue, small grower  | 1.25 |        |
| <b>Elliott.</b> New pink hybrid, opens wide, fine cut flower, fragrant; a popular novelty                | 3.50 |        |
| <b>Independence Pink.</b> A fine pink hybrid   | 2.25 |        |
| <b>Mrs. C. W. Ward.</b> Deep rose pink, star shaped, prolific, fine lily for every pool                  | 2.25 |        |
| <b>Mrs. Ed. Whitaker.</b> Pale blue, large heavy feeder  | 3.00 |        |
| <b>Mrs. Chas. Rey.</b> A dainty pink, blending into white, different from all others                     | 3.50 |        |
| <b>Panama Pacific.</b> Lovely rich reddish purple, free flowering, stiff stems make it a fine cut flower | 2.25 |        |
| <b>Pershing.</b> Large orchid-pink bloom, lovely   | 3.25 |        |
| <b>Pink Zanzibariensis.</b> Large, fragrant, long stemmed, for any pool                                  | 2.00 |        |
| <b>Pring.</b> Fine white, large and fragrant   | 3.00 |        |

**NIGHT BLOOMING TROPICAL WATER LILIES**

The Night Blooming Water Lilies flower in the early morning and evening and will remain open on cloudy days.

- |   |      |        |
|---|------|--------|
| <b>Juno.</b> Very best white night bloomer, large and conspicuous in any pool | Each | \$2.50 |
| <b>Omarana.</b> Large rosy-pink night bloomer                                 |      | 2.00   |
| <b>Rubra Rosea.</b> Gorgeously brilliant crimson, a free bloomer              |      | 2.00   |
| <b>Victoria Cruziana.</b> Suitable only for very large pools                  |      | 10.00  |

**HARDY WATER LILIES**

The Hardy Water Lilies do best if planted in April and are not affected by the temperature changes. They are the earliest to bloom and easiest to care for in the winter season.

- |  |      |        |
|--|------|--------|
| <b>Marliac Pink.</b> Large flowers of soft flesh pink, fragrant  | Each | \$1.25 |
| <b>Marliac White.</b> A vigorous variety, large white flowers. Free flowering                                |      | 1.25   |
| <b>Comanche.</b> Copper-orange with red markings   |      | 3.50   |
| <b>Gladstone.</b> The best white hardy, excepting only Gonnere   |      | 1.50   |
| <b>Gonnere.</b> Petals snowy white. An exceedingly double flower. A free bloomer                             |      | 4.00   |
| <b>Pink Opal.</b> Considered by many the best pink hardy   |      | 2.50   |
| <b>Paul Hariat.</b> Large blooms, orange-pink deepening to red, unique and decidedly one of the best hardies |      | 2.00   |
| <b>Rose Arey.</b> Deep cerise-pink. The finest pink variety  |      | 2.50   |
| <b>Siaux.</b> Opening yellow and changing to red shades as the bloom ages                                    |      | 2.50   |
| <b>Sunrise.</b> Immense bright yellow flowers, by far the finest hardy water lily                            |      | 3.00   |

**LOTUS**

- |   |        |
|---|--------|
| <b>American Lotus.</b> Ivory yellow flowers which attain gigantic proportions                   | \$2.50 |
| <b>Egyptian Lotus or Lily of the Nile.</b> Attractive pink flowers. Quite hardy and free grower | 2.50   |
| <b>Flavescens Lotus.</b> A lovely cream colored bloom   | 2.25   |

**OXYGENATING PLANTS**

- |   |      |        |
|---|------|--------|
| <b>Parrot Feather.</b> A beautiful trailing growth for ponds, fountains or fish bowls | Doz. | \$2.00 |
| <b>Water Hyacinth.</b> A floating plant with bright lilac spikes of flowers           |      | 2.00   |
| <b>Water Poppy.</b> The leaves float upon the surface, flowers large and yellow       |      | 2.50   |

When only one plant is ordered a packing charge of 25 cents will be made.



Hydrangea Otaksa



Tropical Water Lily

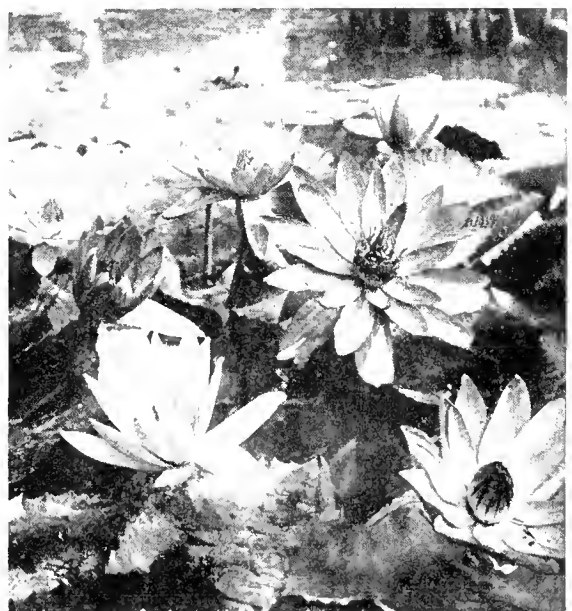

Hardy Water Lily



## Herbaceous Perennials and Rock Garden Plants

Perennials, never more popular than today, comprise most of the best flowers and make a foundation for any garden. They exist in infinite variety and provide a succession of flowers in every conceivable hue from early Spring to late Fall and range in size from the tiniest edging material to the tall plants suitable for a background.

For the best effect it is essential to plant in groups. We are therefore continuing to offer perennials in quantities of not less than three of one variety as satisfactory results cannot be obtained by using one of a kind.

Varieties marked (\*) are suitable for rock gardens.

\***ACHILLEA millefolium roseum**. Pink flowers in compact heads. 2 ft. June-Sept.

**filipendulina**. (Fern-leaved Yarrow; Milfoil). A showy variety with dense heads of yellow flowers. 3 ft. June, July.

**ptarmica, The Pearl**. Double pure white flowers in great profusion. 3 ft. June-Sept.

\***tomentosa** (Woolly Yarrow). Bright yellow, excellent for edging and rockeries. 5 to 6 in. July-Sept.

**ACONITUM autumnale** (Monkshood). Showy blue, helmet-shaped flowers. 3 to 4 ft. Aug., Sept.

**Fischeri**. Strong spikes of large, dark blue flowers. 2 to 3 ft. Sept., Oct.

**napellus**. Long spikes of large dark blue flowers. 3 to 4 ft. July, Aug.

All Aconitums, 3 for \$1.20, 10 for \$3.50.

\***AETHIONEMA iberidum** (Stone Cress). Tufts of grey-blue foliage with clusters of snowy white flowers. Very hardy. 8-10 in. June, July. 3 for \$1.25, 10 for \$3.50.

**AGROSTEMMA**. (See **Lychnis**.)

\***AJUGA reptans rubra**. A creeping plant with numerous spikes of blue flowers. Good for shady places. 5-6 in. May, June.

**ALTHAEA ROSEA**. (See **Hollyhock**.)

\***ALYSSUM saxatile compactum** (Rock Madwort, Golden Tuft). Compact masses of yellow flowers in early Spring. 1 ft. April, May.

**AMSONIA tabernaemontana**. A strong, shrub-like plant, with spikes of delicate blue flowers. 2 ft. May, June.

**ANCHUSA italica, Dropmore**. Large gentian-blue flowers. 4 to 5 ft. May-July.

\*—**myosotidiflora**. Bright blue Forget-me-not flowers. 10 to 12 in. May. 3 for \$1.10, 10 for \$3.00.

\***ANDROSACE lanuginosa** (Rock Jasmine). Trailing growth and soft silvery foliage. Soft lilac-rose blossoms lasting nearly all summer. 3 for \$1.80, \$5.00 for 10.

**ANEMONE** (Windflower). Japanese Anemones are among the best Autumn flowering plants. 2 to 3 ft. Sept., Oct.

**japonica**. Rosy red.

**japonica alba**. Single, pure white.

—**Alice**. Lovely rose pink.

—**Mount Rose**. Semi-double pink.

—**Whirlwind**. Semi-double, white.

All plants, except where noted, 3 for 90c, 10 for \$2.50. Not less than 3 of 1 variety sold. Write for special prices for plants in quantity.

\***hupehensis** (Chinese Anemone). Resembles the Japanese Anemone in a miniature way, rosy mauve flowers. 18 to 24 in. Aug., Sept.

\***pulsatilla**. The Pasque Flower of Europe. Flowers single, blue or reddish-purple, about 2 in. across. Height 1 ft. April to May.

\***sylvestris**. Fine for cool moist corner of rock garden. Large white blossoms on nodding stems. 12 in.

All Anemones, 3 for \$1.00, 10 for \$3.00.

**ANTHEMIS nobilis** (Camomile). A beautiful bushy plant with single white rayed flowers. 18 in. June, July.

**tinctoria Kelwayi** (Golden Marguerite). Rich yellow; fine for cutting. 3 ft. June-Oct.

**ANTHERICUM liliastrum major** (St. Bruno's Lily). Grass-like foliage, spikes of small lily-like white flowers. 18 in. May, June. \$1.25 for 3, \$3.50 for 10.

**AQUILEGIA coerulea** (Rocky Mountain Columbine). Large, blue and white, long-spurred flowers. 1¼ ft.

\***Chrysantha** (Golden-Spurred Columbine). Flowers fragrant, yellow. 2 to 3 in. across.

\***Canadensis** (American Columbine). A compact plant with red and yellow flowers.

**Mrs. Scott Elliott Hybrids**. There is not a better mixture grown in the world than by Mrs. Scott Elliott who has taken the highest awards at all the European exhibitions. Our stock is from seed from this source, absolutely true strain.

\***ARABIS alpina** (Rock Cress). Adapted for rock gardens; pure white. 5 in. April, May.

\***flore pleno**. An improved double form of the above with pure white flowers which last over a long period. Fine as edging or for Rock Garden. 6 in. April-May. 3 for \$1.10, 10 for \$3.00.

\***ARENARIA balearica** (Sandwort). Useful for dry walls and in the rockery. White flowers through the summer. 1 in. 3 for \$1.00, 10 for \$3.00.

\***ARMERIA cephalotes rubra** (Sea Pink). Densely tufted plants with grass-like foliage. Crimson flower heads on tall slender stems. 12-18 in. July, Aug.

\***lauchiana**. Bright rose-colored flowers, excellent for edging or rock gardens. 3-6 in. April to June.

**ARTEMISIA abrotanum** (Southernwood; Old Man). Usually grown for its handsome, pleasant-scented leaves. 2 to 3 ft. 3 for \$1.10, 10 for \$3.00.

**lactiflora**. Large, branching panicles of sweetly scented, creamy white flowers. 3 to 4 ft. Aug., Sept.

**Silver King**. Silvery white foliage.

\***Stelleriana** (Old Woman). Foliage deeply cut; silvery white; a fine plant for rockeries. 1½ ft.

**ASCLEPIAS tuberosa** (Butterfly Weed). Orange-scarlet. 2 ft. July, Aug.

\***ASPERULA odorata** (Sweet Woodruff, Waldmeister). A sweet-scented herb; white. 6 to 8 in. May, June.

**ASTERS. Hardy.**

- \***alpinus**. Showy blue flowers on good stem. 6-9 in. May, June.
- \***Alpinus, Goliath**. Large lilac flowers with distinct golden center. 9 in.
- \***Farreri, Big Bear**. With beautiful flowers of the richest violet, orange center, for rock garden or border. 3 for \$1.20, \$3.00 for 10.
- \***Mauve Cushion**. An entirely distinct species. It forms a circular cushion-like plant 2½ feet across, rarely exceeding 9 inches in height; the flowers, of delicate, soft mauve, completely cover the plant; the blooms begin to expand early in October, but are not at their best until November.

**ASTER** (Michaelmas Daisy).

- Beauty of Colwall**. Clear, lavender-blue, semi-double flowers. 4 ft. Sept., Oct.
- Climax**. Large, soft mauve flowers with golden center. 5 to 6 ft. Sept., Oct.
- Feltham Blue**. Splendid blue with yellow center. 3 to 4 ft. Sept., Oct.
- Lady Lloyd**. Clear rose-pink. 3 ft. Sept., Oct.
- Perry's Favorite**. Bright, luminous pink. 3 to 4 ft. Sept., Oct.
- Perry's White**. Pure white, free flowering. 5 ft.
- St. Egwin**. Pink, compact habit. 3 ft. Sept.
- Tataricus**. Tall straight growth, large violet flowers. 6 ft. Oct.

**ASTILBE, Arendsi Hybrids.**

- Gloria**. A superb introduction with dense, feathery, dark pink plumes. A compact grower. 2 ft. 3 for \$1.50, 10 for \$4.50.
- Salland**. Immense feathery spray of rich red flowers. 6 ft. 3 for \$1.50, 10 for \$4.50.
- Vesta**. A pretty plant with graceful blooms of lilac-rose. 3 ft. 3 for \$1.50, 10 for \$4.50.

**AUBRIETIA.** One of the most essential plants for the rock garden. 6 in. April, May.

- deltoides**. Rich mauve blue.
- graeca**. Light blue flowers, compact.
- Leichtlini**. Ruby-red.

**AURICULA.** (See *Primula*.)

**BAPTISIA australis** (False Indigo). Lupine-like flowers, dark blue. 3 to 4 ft. May-July.

**BLEEDING HEART.** (See *Dicentra*.)

**BOCCONIA cordata** (Plume Pappy). Creamy white flowers. 6 to 8 ft. July, Aug.

**BOLTONIA asteroides**. Has pure white, Aster-like flowers. 5 to 6 ft. Aug., Sept.

- latisquama**. Similar to the preceding, with pinkish-lavender flowers. 5 to 6 ft. Aug., Sept.
- nana**. A dwarf form. 3 ft. Aug., Sept.

**CALTHA palustris** (Marsh Marigold). Showy plant for wet places, with bright yellow flowers. 12 in. June.

**CALLIRHOE invaluata**. Trailing habit with crimson flowers lasting all summer. Full sun.

**CAMPANULA** (Bellflower). These are among the most important of hardy plants

- \***carpatica** (Harebell). Flowers large, erect, light blue. 5 to 7 in. July, Aug.
- \*—**alba**. A white form of the above.
- \***Garganica**. A gem for the rock garden. Forms low spreading tufts covered in June with starry light blue flowers. 3 for \$1.20; \$3.00 for 10.
- glomerata**. Globular, dark blue flowers. 1½ ft. June, July. 3 for \$1.25, 10 for \$3.50.
- medium** (Canterbury Bells). In blue, rose or white. 2 ft. June.
- calycanthema** (Cup-and-saucer Canterbury Bells). In blue, rose and white.
- persicifolia** (Peach-leaved Bellflower). Large cup-shaped blue flowers. 2 ft. June, July.
- alba grandiflora**. White.
- Telham Beauty**. Large, single blue flowers. A great improvement on the old *Persicifolia* type. Fine for cutting. 2½ ft. June, July. 3 for \$1.00, 10 for \$3.00.

\***Partenschlageana** (Muralis). Very dwarf plant covered with blue-purple flowers in June. Fine for rock garden. 3 for \$1.25, 10 for \$3.50.

**pyramidalis** (Steeple Bellflower). Long spikes of blue flowers. 4 to 5 ft. Aug., Sept. 3 for \$1.25, 10 for \$3.50.

—**alba**. A white form of the above. 3 for \$1.25, 10 for \$3.50.

\***ratundifolia** (Harebell). Clear blue, specially suited for crevices in rock gardens. 9 in. June to Aug.

**CARYOPTERIS incana** (*Mastacanthus*) (Blue Spiraea). Lavender-colored flowers. 3 to 4 ft. Sept., Oct. 3 for \$1.50, 10 for \$4.50.

**CASSIA marilandica**. Bright yellow, odd-shaped flowers. 5 to 6 ft. July-Sept.

**CATANANCHE** (Cupid's Dart).

- Caerulea**. 2 feet. July and August. Heads of pretty deep blue flowers on long stems. Profuse and excellent cut flowers.
- Bicolor**. Similar to *Caerulea*, with white center.

**CENTAUREA dealbata**. Compact habit; deep pink flowers. 1½ ft. July, Aug.

**macrocephala**. The most showy *Centaurea*, with large, thistle-like yellow flowers. 3 ft. July, Aug.

\***mantana** (Perennial Carnflower). Large blue flowers. 2 ft. June-Sept.

\*—**alba**. A fine white form of the above.



Armeria Lauchiana



Mauve Cushion Aster



Campanula Carpatica

All plants, except where noted, 3 for 90c; 10 for \$2.50. Not less than 3 of 1 variety sold. Write for special prices for plants in quantity.

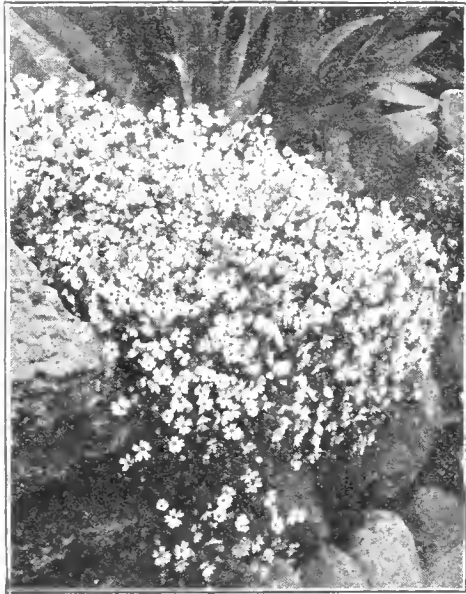

**Cerastium Tomentosum**



**Hardy Chrysanthemum, Ouray**



**Dictamnus Fraxinella**

**CEPHALARIA alpina** (Roundheads). Very tall. Flower heads pale primrose-yellow. 5 ft. June, July.

\***CERASTIUM tomentosum** (Snow-in-Summer). Bright, silvery foliage, with white flowers. 6 in. May, June.

**CHELONE** (Turtlehead). Handsome perennials, growing about two feet high, and bearing numerous spikes of large flower heads. Summer and Fall.  
**glabra alba**. Terminal spikes of creamy white flowers.  
**Lyoni**. Heads of showy purplish red flowers.

**CHRYSANTHEMUM** (Shasta Daisy).  
**arcticum** (Arctic Daisy). Multitudes of white slightly tinted flowers, 2 in. wide. 12 to 18 in. Sept.-Nov.  
**maximum, King Edward**. Marguerite-like flowers of glistening white. 3 ft. July-Oct.  
**maximum, The Speaker**. Ivory-white flowers nearly six inches in diameter. 2½ ft. July-Oct.  
**maximum, Shasta Daisy**. Large white flowers; blooms profusely all Summer.

**Hardy Chrysanthemums.**  
**Small Double and Button.**  
**Anna L. Moran**. Bright scarlet-bronze.  
**Capt. R. H. Cook**. Tall deep rose.  
**Cheerfulness**. One of the best yellow buttons.  
**Ethel**. Bright red miniature.  
**Irene**. Pure white.  
**Little Dot**. Small deep bronze button.  
**October Dawn**. Early light pink.  
**Ouray**. Rather large bronze button of dazzling color.  
**Skibo**. Medium size, pure yellow.  
**Yellow Gem**. Canary-yellow without shading.

**Single Type**  
**Alice Howell**. Bronzy orange-yellow.  
**Dazzler**. Brilliant cardinal-red.  
**Donald Wells**. Earliest white flowering.  
**Modesty**. Large pale rose.

**Decorative Type**  
**Aladdin**. Exceptionally early, warm bronze with an overlay of orange-apricot.  
**Alice Howell**. Orange, yellow, and bronze.  
**Barbara Cumming**. Extra-early yellow Aster.  
**Frances Whittlesey**. Garnet and bronze Aster.  
**Oconta**. Large white Aster.  
**October Gold**. Orange-yellow Aster.  
**Petite Louise**. Large rose-pink Aster.  
**Provence**. Soft pink, blended yellow.  
**Ruth Cumming**. Rich reddish bronze.  
**Yellow Normandie**. Light bronzy yellow.  
**Zelia**. Orange-bronze Aster.

Any of the above, 2-inch pots—3 for 75c; \$2.50 per doz.; \$15.00 per 100.

For Korean and new hardy varieties, see page 75.

**CIMICIFUGA racemosa**. Tall and ornamental; white flowers. 4 to 5 ft. June, July.  
 —**simp'ex**. Tall, graceful spikes of white flowers, lasting a long time when cut. 2 to 3 ft. Sept., Oct. \$1.00 each, \$8.50 for 10.

**CONVALLARIA majolis** (Lily-of-the-Valley). May, June. Field grown clumps. \$2.50 for 5, \$4.50 for 10, \$40.00 per 100.

**COREOPSIS lanceolata**. Golden yellow flowers on long, graceful stems, making them invaluable for cutting. 2 ft. June-Oct.

\***DAPHNE cneorum** (Garland Flower). Unusually attractive, dwarf, bushy evergreen plant, the branches spreading from crown, forming solid mass, bearing bright pink flowers at tip of every branch during May and August. 6 to 9-in. spread, 85c each, \$8.00 for 10; 9 to 12-in. spread, \$1.25 each, \$12.00 for 10.

**DELPHINIUM** (Larkspur). June till late fall.  
**Belladonna**. Large, semi-double flowers, sky-blue, tipped lilac; dwarf growing.  
**English Hybrids**. From the palest to the deepest blues; single and double.  
 —**grandiflorum chinense** (Chinese). Low-growing, with gentian-blue flowers  
 — — **alba**. A white form of the preceding.  
**Wrexham Hybrids**. Magnificent spikes of exquisite flowers compactly arranged along the stems. The choicest of all delphiniums. Each, \$1.00; 10 for \$9.00; 100 for \$75.00.

**DIANTHUS** (Hybrid Garden Pinks).  
 \***Abbotsford**. Deep crimson marked with white.  
 \***Carmen**. Light pink, fragrant.  
 \***Essex Witch**. Bright pink.  
 \***Mrs. Sinkins**. Large white fragrant flowers.  
 \***alpinus**. Pure pink flowers.  
**barbatus** (Sweet William). One of the oldest garden flowers which perpetuates itself by self-sowing.  
 —**Single Mixed**.  
 —**Newport Pink**. Lovely salmon-pink.  
 —**Scarlet Beauty**. Deep rich scarlet.  
 \***caesius** (Cheddar Pink). Very sweet-scented rose-colored flowers.  
 \***deltoides** (Maiden Pink). A dwarf variety with creeping habit, with sprays of pink flowers.  
 \***plumarius** (Grass Pink). Single fringed flower in mixed colors. 1 ft.

\***DICENTRA eximia**. Fernlike foliage with rose-pink flowers on graceful arching stems. Flowers all summer. 18 in.

**farmosa**. Rose color, with finely divided foliage. 1 ft. May, Aug. 3 for \$1.20.

**spectabilis** (Bleeding Heart). Long, drooping racemes of rose-crimson; useful for forcing. 1½ ft. April-June. 75c each, \$6.00 for 10.

**DICTAMNUS fraxinella** (Gas Plant). This is also called Burning Bush. 2 to 3 ft. June, July. 3 for \$1.25, 10 for \$3.50.

All plants, except where noted, 3 for 90c; 10 for \$2.50. Not less than 3 of 1 variety sold. Write for special prices for plants in quantity.





**Doronicum caucasicum**



**Gentiana Andrewsii**



**Geranium sanguineum**

**DIGITALIS** (Foxglove). These old garden favorites produce bold masses of leaves and flowers.

**lanata**. Long, dense spikes of grayish or creamy-yellow flowers. 2 to 3 ft. June, July.

**purpurea glaxinioeflora** (Gloxinia-flowered Foxglove). Flowers spotted rose, purple and white. 2 to 3 ft. June, July.

—**Shirley Hybrids**. A giant variety of the Gloxinia-flowered type. Flower spikes 4 ft. long of purest white to deepest rose colors, handsomely spotted. 5 to 7 ft. June and July.

**DORONICUM caucasicum** (Leopardbane). Yellow Daisy-like flowers, blooming very early. A good cut flower. 1 ft. May, June 3 for \$1.25, 10 for \$3.50.

\***DRABA repens**. A graceful plant of trailing growth with numerous bright yellow flowers in early spring. 3 for \$1.20, \$3.00 for 10.

**ECHINACEA purpurea** (Purple Coneflower). Reddish purple flowers, 4 in. in diameter. 3 to 4 ft. July, Aug.

**ECHINOPS ritra** (Golden Thistle). A showy plant, with globular heads of blue flowers, thistle-like foliage. 3 to 4 ft. July, Aug.

\***EPIMEDIUM alpinum** (Bishop's Hat). Leathery bronze foliage, small yellow flowers. May. 3 for \$1.75, 10 for \$5.00.

**EREMURUS**. See our Fall catalog.

\***ERIGERON speciosus** (Fleabane). Large, handsome, blue flowers with yellow center resembling a Michaelmas Daisy. 1½ ft. July, Aug.

\***ERINUS alpinus**. A tiny plant for massing amongst stones, rosy-purple flowers. May, June. 3-4 in.

\***ERYSIMUM pulchellum**. Valuable plant for rockery in full sun. Brilliant orange blossoms on stems 6 to 12 in. high.

**ERYNGIUM alpinum** (Sea Holly). Flowers 3 in. across, of a steel blue. 2 ft. July, Aug.

**amethystinum**. Beautiful thistle-like heads of glistening amethyst-blue. 2 to 3 ft. July-Sept.

**EUPATORIUM caelestinum** (Mist Flower). A good hardy plant, with light blue flowers, similar to Ageratum. 2 ft. Aug.-Oct.

**purpureum** (Joe Pye Weed). Purple; fine for wild garden. 6 to 7 ft. July-Sept.

**EUPHORBIA corollata** (Flowering Spurge). Pretty little white flowers. 2 to 3 ft. July, Aug.

\***EUPHORBIA myrsinites**. A creeping plant with bluish leaves and orange-yellow flowers. 4-6 in. May, June. 3 for \$1.25, 10 for \$3.50.

**FERNS, Hardy**. Vauable for planting in shady, moist situations and under trees where blooming plants will not thrive. As a rule they should be grown in a moist, shady and protected place, in a soil composed of rich loam and leaf-mold.

\***Adiantum pedatum** (Hardy Maidenhair Fern).

\***Aspidium acrostichoides** (Christmas Fern). An evergreen variety with deep green fronds about a foot high.

**FERNS—**

—**spinulosum**. Another evergreen variety growing 18 to 24 in. high.

\***Asplenium angustifolium**. A charming Fern with light green, graceful fronds 1 to 3 ft. high.

—**Filix-foemina**. A large, handsome Fern with finely cut foliage about 2 to 3 ft. high.

**Dicksonia punctilobula**. A variety which will grow in sun or shade, growing about 18 in. high. Where masses of Ferns are desired, this variety cannot be surpassed.

**Onoclea struthiapteris** (Ostrich Fern). A very handsome variety which resembles a palm, growing from 2 to 4 ft. high. A very good Fern for growing as a background for smaller varieties.

**Osmunda cinnamomea** (Cinnamon Fern).

—**regalis** (Royal Fern).

**FUNKIA**. Very handsome and will thrive in almost any position. 1½ to 2 ft. July, Aug.

**caerulea**. Purple flowers; large, green foliage.

**lancifolia albo-marginata**. Leaves edged with white.

**plantaginea grandiflora** (F. subcordata grandiflora). Large, pure white flowers and bold foliage make this a very attractive variety. 3 for \$1.25, 10 for \$3.50.

**GAILLARDIA grandiflora** (Blanket Flower). Yellow and orange-red. 1½ ft. May-Nov.

**Portala**. A race of hybrids whose colors range from reddish bronze to deep gold. An excellent large flowering strain.

**GALEGA officinalis** (Goat's Rue). Rosy purple flowers. 3 to 4 ft.

—**alba**. White flowers; fine for cutting. 3 to 4 ft. July.

\***GENTIANA acaulis**. Very large blue flowers covering a dwarf green carpet. Gentians enjoy peat mixed with light loam and fine stones. 3 for \$3.00, \$9.00 for 10.

\***Andrewsi** (Closed, or Bottle Gentian). Flowers of a fine blue. 18 to 24 in. Aug., Sept.

\***GERANIUM sanguineum** (Cranesbill). Fire-red; very effective. 1 to 1½ ft. May-July.

**GEUM atrosanguineum** (Avens). Dark crimson. 1 to 2 ft. May-July.

**Heldreichi**. Orange; very free flowering; fine foliage. 1½ ft. May-July. 3 for \$1.25, 10 for \$3.50.

\***Lady Stratheden**. The large double flowers are a rich golden color. Flowers the greater part of Summer and Fall. 2 ft. June-Sept.

**Mrs. J. Bradshaw**. Double dark red flowers. 2 ft. June-Sept.

**GRASSES—**

**Eulalia japonica variegata** (Miscanthus). Long, narrow leaves striped green, white, pink and yellow. 4 to 6 ft.

—**japonica zebrina**. Very striking with leaves banded transversely with pale yellow. 5 to 6 ft.

\***Festuca glauca**. A pretty dwarf grass, with tufts of fine, bluish green foliage. 1 ft.

**Phalaris arundinacea picta** (**arundinacea variegata**). (Variegated Ribbon Grass; Gardener's Garters). 2 to 3 ft.

All plants, except where noted, 3 for 90c; 10 for \$2.50. Not less than 3 of 1 variety sold. Write for special prices for plants in quantity.

**GYPSOPHILA paniculata** (Baby's Breath). Masses of minute, pure white flowers, 2 to 3 ft. June, July.

—**Bristol Fairy**. A new, double-flowering Baby's Breath. Very early and blooms until Fall. Field-grown, grafted plants. 3 for \$1.50, \$4.50 for 10.

—**flore-pleno**. Charming, double flowers borne on branched panicles in great profusion. July-Aug. 3 for \$1.50, \$4.50 for 10.

**acutifolia** (Chalk Plant). Rose-colored flowers. 3 to 4 ft. July, Aug.

\***repens**. A lovely trailing variety with clouds of white or pale pink flowers in July and August. Good rock plant.

**HELIENIUM autumnale** (Sneezeweed). A grand plant, with large, flat, lemon-yellow flowers. 4 to 5 ft. Aug., Sept.

**Hoopesi**. The earliest flowering of all the Heleniums and the only one with pure orange-colored flowers. 2 to 3 ft. May, June.

**pumilum magnificum**. A most useful border plant with large golden yellow flowers. July to Oct. 12 to 18 in. 3 for \$1.25, 10 for \$3.50.

—**Riverton Beauty**. Rich lemon-yellow, with large purplish black cone. 5 ft. Aug., Sept.

—**Riverton Gem**. Yellow, changing to red. 5 ft. Aug., Sept. 3 for \$1.25, 10 for \$3.50.

**HELIANTHEMUM** (Sun Rose).

\***Fireball**. Double red. 4-5 in. June-Aug.

\***The Bride**. Delicate white. 8-10 in. June-Aug.

\***Vulgare**. Almost a shrubby evergreen plant, flowers yellow. 8-10 in. June-July.

**HELIANTHUS** (Hardy Sunflower). The large flowers on long stems are fine for cutting.

**Maximiliani**. One of the latest blooming of all; clear yellow. 6 to 8 ft. Oct., Nov.

**mollis**. Thick, velvety foliage of a silvery tinge; flowers lemon-yellow. 5 ft. Aug., Sept.

**multiflorus**. (Double Golden Thin Leaf Sunflower). Aug.-Sept. 4 ft.

**Wooley Dod**. Very free flowering, bright yellow, semi-double. 6 to 7 ft. Sept.

**HELIOPSIS Pitcheriana**. The flowers are deep golden yellow, about 2 in. in diameter. 3 to 4 ft. July-Sept.

**HEMEROCALLIS flava** (Lemon Day Lily). Flowers lemon-yellow, sweet-scented. 3 ft. May.

**fulva**. Large flowers of a rich bronze-orange. 2 to 3 ft. June-Aug.

**Middendorffi**. Flowers deep orange-yellow. Desirable for cutting. 2 to 3 ft. June, July.

**Thunbergi**. Flowers lemon-yellow, very fragrant. 3 ft. July, Aug.

**HEUCHERA sanguinea**. The bright crimson flowers are borne in long, graceful, arching sprays. 1½ ft. May-Sept.

\***hybrida**. Assorted colors. 1½ ft. May-Sept.

**HOLLYHOCK** (*Althea rosea*). 5 to 6 ft. July, Aug.

**Single**. In crimson, rose, salmon, white or yellow.

**Double**. In carmine-rose, crimson, yellow, rose-salmon and white colors.

**HIBISCUS** (Mallow Marvels). The flowers range in color from white to intense crimson. 5 to 8 ft. July-Sept. 3 for \$1.25, 10 for \$3.50.

\***HYPERICUM repens**. A creeping plant with dark foliage and yellow flowers. 4-6 in.

\***IBERIS sempervirens** (Evergreen Candytuft). Flowers pure white, completely covering the plant. 12 in. May.

**gibraltarica**. Flowers shading from lavender to white. Strong grower.

\***INULA ensifolia** (Fleabane). Yellow; small flowers. 8 in. July-Sept. 3 for \$1.20, 10 for \$3.50.

### IRIS, JAPANESE

The Japan Iris is perfectly hardy and flowers in great profusion in July and August.

The large size of the flowers is noteworthy, as they often reach 6 to 8 inches across in most fascinating combinations.

**Catherine Parry**. Double, blue overlaid rosy-red.

**Eleanor Parry**. Double, claret-red, flamed white and blue.

**Fascination**. Double, blue lightly veined white, pink tinge.

**Grace Sperling**. Single, hortense violet, petaloid stigmas light hortense violet. Very early.

**Gold Bound**. Large, pure white, yellow center.

**Helen von Siebold**. Reddish violet, veined white.

**Lucie Marshall**. An immense double with six petals of pansy-violet color with distinct white veins coming from a golden yellow center. Stems 4 ft.

**Oriole**. Large, double flowers of rich plum-red, shaded deep purple.

**Pyramid**. Light blue, center of petals veined white.

**Templeton**. Light blue, center of petals veined white.

**Victor**. White, veined violet-blue, purple center.

Prices of the above, strong clumps. Three for \$1.75. Dozen, \$6.00.

### IRIS, SIBERIAN

Narrow, glossy foliage, delicate flowers on tall stems. Excellent for cutting as the blooms keep well in water and can be used with other flowers.

**Sibirica orientalis**. Purplish blue. 2 to 3 ft. 3 for \$1.50, 10 for \$4.00.

**Sibirica, Perry's Blue**. A large flower of clear blue with horizontal falls. 4 ft. 3 for \$2.50, 10 for \$7.00.

**Snow Queen**. Flowers pure white. A strong growing variety. 3 for \$1.50, 10 for \$4.00.

**IRIS germanica** (Garden Iris). See Fall Catalog.

\***IRIS cristata**. A native of North America with grass-like foliage and large lilac flowers.

\***pumila aurea**. (Pygmy Iris). Large showy flowers on plants 6 or 8 in. high of the same general appearance as the German Iris. Bright yellow.

\***pumila cyanea**. Deep blue variety of above.

\***pumila, Spring Skies**. Clear light blue.

\***pumila, White Queen**. Pure white.

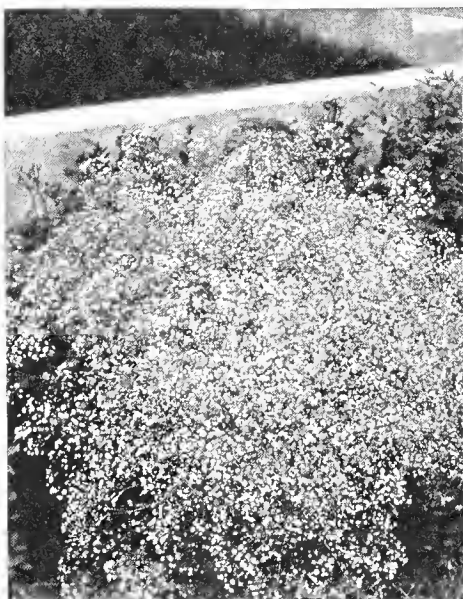

Gypsophila, Bristol Fairy



Iberis Sempervirens

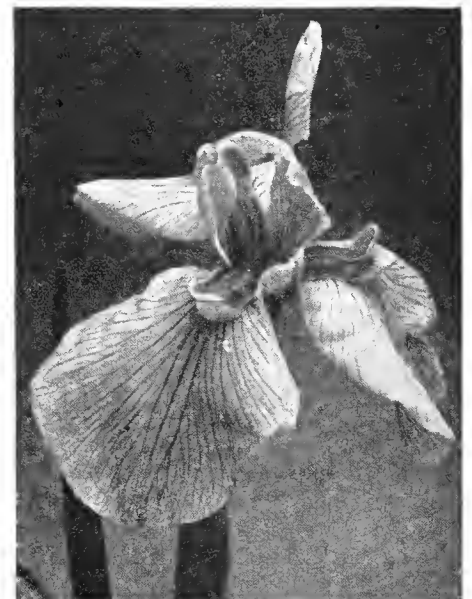

Japanese Iris

All plants, except where noted, 3 for 90c; 10 for \$2.50. Not less than 3 of 1 variety sold. Write for special prices for plants in quantity.

- LATHYRUS latifolius** (Everlasting Pea). Flowers rose-colored, large, on many-flowered stems, similar to the annual Sweet Pea. 3 ft. June-Aug.  
 —**albus**. A variety of the preceding, with white flowers. Very desirable. 3 ft. June-Aug.
- LAVANDULA vera** (Sweet Lavender). Fragrant blue flowers. 1½ ft. July-Sept. 3 for \$1.25, 10 for \$3.50.
- \***LEONTOPODIUM alpinum** (Ede weiss). A well-known Alpine plant for dry situations. 6-8 in. June-Aug. 3 for \$1.25, 10 for \$3.50.
- \***LEWISIA Tweedyi**. The largest flowered *Lewisia*. Waxy apricot flowers 2 to 3 in. across. Should have good drainage and partial shade. 3 for \$2.10, \$6.00 for 10.
- \***LINARIA cymbalaria** (Kenilworth Ivy). Trailing species covered all spring and summer with little orchid-like flowers. Beautiful foliage.
- LIATRIS pycnostachya** (Kansas Gay Feather). Flowers purple, in dense spikes. 4 to 5 ft. July, Aug.  
**spicata** (Button Snakeroot). Spikes 6 to 15 in. long; purple. 2 to 3 ft. July-Sept.
- LILY-OF-THE-VALLEY**. (See *Convallaria*.)
- \***LINUM perenne** (Flax). A lovely plant, with blue flowers. 1½ ft. May-Aug.  
 \*—**album**. A white form of the above.
- LOBELIA cardinalis** (Cardinal Flower). Flowers intense scarlet. 3 ft. July, Aug.  
**syphilitica**. Fine spikes of blue flowers. 3 ft. Aug., Sept.
- LUPINUS polyphyllus** (Lupine). Deep blue, pea-shaped. 3 to 4 ft. June, July.  
 —**albiflorus**. A white form of the above.  
 —**Moerheimi**. Color soft rose. June-July.
- \***LYCHNIS alpina**. A very attractive little plant of tufted growth, bearing heads of pink blossoms in May and June. 2 to 3 in.  
**chalconica**. Flowers bright scarlet, in dense clusters. 2 ft. June, July.  
**coronaria** (*Agrostemma coronaria*). Flowers rich crimson, produced in great abundance on long stems. 2 ft. June, July.  
**viscaria splendens flore pleno**. A fine variety, with double, crimson flowers. 1 ft.
- LYTHRUM salicaria roseum, Perry's Variety**. A most beautiful shade of cherry-red. 2 to 3 ft. July-Sept.
- LYSIMACHIA clethroides** (Loosestrife). A fine hardy variety from Japon, with long spikes of pure white flowers. 2 ft. July-Sept.  
 \***nummularia** (Creeping Jenny; Moneywort). Yellow flowering creeping plant. June, July.
- MALVA moschata** (Musk Mallow). Flowers rose; sweet-scented 1 to 2 ft. June-Sept.  
 —**alba**. A charming plant; flowers white. 1 to 2 ft. June-Sept.
- \***MAZUS rugosa**. Good between stepping stones. Flowers lilac. 1 in. May, June. 3 for \$1.25, 10 for \$3.50.
- \***MERTENSIA virginica** (Virginia Cowslip). Flowers blue, funnel-formed, in nodding clusters. 1½ ft. May, June.
- \***MITCHELLA repens**. (Partridge Berry). Trailing evergreen plant for shade. Red berries. 4 in. Sept., Oct.
- MONARDA didyma**. Compact heads of bright red flowers. 3 ft. June-Aug.  
**didyma, Cambridge Scarlet**. Next to the scarlet lobelia, the most brilliant of our wild flowers.
- \***MYOSOTIS alpestris**. One of the most intense blues of all the Forget-me-nots. Compact growth. 9 in.  
 \***palustris semperflorens** (Forget-me-not). Color blue; good for shady spots in the rock garden. 10 in. May-Sept.
- \***NEPETA hederacea (Glechoma)**. Blue; a beautiful evergreen plant of creeping habit; fine for rockwork. 5 in. May, June.  
 \***Mussini**. Mauve-colored flowers; blooms constantly. Forms a springy tuft or mat of soft, velvety, gray-green, aromatic foliage. 8 in. April-June.  
 \***Souv. d'Andre Chaudron**. Racemes of deep blue flowers on 18 inch stems. 3 for \$1.40, \$3.25 for 10.
- \***NIEREMBERGIA rivularis**. Carpets of dark green leaves with a profusion of large white flowers on 1-inch stems. Flowers all summer in full sun.
- OENOTHERA fruticosa major** (Evening Primrose). Bright yellow flowers. 2 ft. June.  
 \***missouriensis**. Large, yellow flowers. 10 in. June-Aug.
- \***PACHYSANDRA terminalis**. One of the most valuable evergreen plants for dense shade. 2-yr.-old field grown, \$15.00 for 100, 2¼ in. pots, \$20.00 for 100.
- \***PAPAVER nudicaule** (Iceland Poppy). White, yellow, orange. 9 in. May-Aug.  
**orientale** (Oriental Poppy). Glowing scarlet, black blotch. 2 to 3 ft. May, June.  
**Hybrid Oriental Poppies**.  
 —**Beauty of Livermore**. Deep crimson. 3 ft. May, June.  
 —**Mrs. Perry**. Pink. 3 ft. May, June.  
 —**Perry's White**. White. 3 ft. May, June.  
 —**Princess Victoria Louise**. Soft salmon-pink.  
 —**Royal Scarlet**. Brilliant scarlet. 3 ft. May, June.  
 All Hybrid Oriental Poppies. 3 for \$1.20, \$3.50 for 10.
- PARDANTHUS chinensis (Belamcanda)** (Blackberry-lily). Bright orange, lily-like flowers during July and August, followed in September by seeds which resemble Blackberries; 2½ feet. 3 for \$1.20, \$3.00 for 10.



Leontopodium Alpinum



Lewisia Tweedyi



Oriental Poppy Hybrids

All plants, except where noted, 3 for 90c; 10 for \$2.50. Not less than 3 of 1 variety sold. Write for special prices for plants in quantity.



Phlox Decussata



Polemonium Reptans



Salvia Azurea

**PENTSTEMON barbatus Torreyi** (Beard Tongue). Tall spikes of brilliant scarlet flowers. 4 ft. June-Aug.

**digitalis**. White, tubular flowers with purple throat. 2 ft. July, Aug.

—**heterophyllus**. One of the best, spikes of sky blue flowers, shaded amethyst. 1 ft. June.

**PEONIES**. (See Fall Catalog).

**PHLOX**. Phloxes are among the very showiest and valuable of all hardy plants. Effective for planting in broad masses in the perennial border or for cutting for indoor decoration, their brilliant coloring places them in the front ranks of desirable flowers. 2 to 3 ft. June-Oct.

**decussata**

**Baron Von Dedem**. Brilliant salmon-red.

**B. Comte**. Glowing amaranth-red.

**Columbia** (Plant Patent No. 118). 2-2½ ft. Bushy. Disease- and insect-resistant, dark green foliage bearing huge trusses of soft cameo-pink flowers with a pale blue eye. 3 for \$1.50, 10 for \$4.00.

**Commander-in-Chief**. Splendid crimson-red with darker eye.

**Debs**. The finest red variety. Color is bright fiery crimson. 3 for \$1.25, 10 for \$3.25.

**Elizabeth Campbell**. Immense trusses of salmon-pink. 3 for \$1.25, 10 for \$3.25.

**Jeanne d'Arc**. Massive spikes; pure white, late flowering.

**Jules Sandeau**. A large, free-flowering salmon-pink.

**Le Mahdi**. Large heads of deep velvety purple.

**Maid Marion**. Lavender.

**Michael Buchner**. Dark purple.

**Mrs. Jenkins**. Large trusses of pure white.

**Mrs. Milly Von Hoboken**. Bright pink, with mauve suffusion.

**Rheinlander**. Immense blossoms of salmon-pink, claret eye.

**Tapis Blanc**. Dwarf, with immense heads of white flowers.

**Thor**. Rich salmon-pink with crimson eye.

**W. C. Egan**. Large flowers; delicate lilac with red eye.

**suffruticosa, Miss Lingard**. An early flowering type with large heads of white flowers with faint lilac eye. June, July. 3 ft.

**Phlox, Dwarf Varieties:**

\***amaena**. A prostrate type with bright pink flowers in April and May. Good in rock garden. 4 inches.

\***divaricata (canadensis)**. Masses of large fragrant lavender flowers in April and May. 10 inches.

\***subulata** (Moss Pink). A prostrate creeping type with moss-like foliage and profusion of pink flowers. 6 inches. April, May.

\*—**alba**. The White Moss-Pink. Very chaste.

\*—**Vivid**. Bright rose.

**PHYSALIS Francheti** (Chinese Lantern Plant). Enormous orange-colored fruits; useful for Winter decorating. 2 ft. April, May.

**PHYSOSTEGIA virginiana** (False Dragonhead). Strong spikes of delicate pink flowers. 2 to 3 ft. June, July.

—**alba**. Flowers pure white. 2 to 3 ft. June, July.

—**grandiflora, Vivid**. Unusually large flowers, deep pink. 15 in. Sept., Oct.

**PLATYCODON grandiflorum** (Balloon Flower). A dense branching plant of upright habit; flowers 3 in. across, blue. 1 to 2 ft. June, July.

—**album**. A white flowered form of the above.

\***PLUMBAGO larpentae**. One of the best late flowering rock plants. A lovely plant covered with azure-blue flowers. 9 in. 3 for \$1.20, 10 for \$3.00.

\***POLEMONIUM reptans**. The fernlike foliage of this plant is very effective. Lovely bells of pale blue flowers on slender stems. Trailing habit.

**POLYGONATUM multiflorum** (Solomon's Seal). Arching sprays of greenish-white flowers; useful for cutting. 2 ft. May, June.

**POPPY**. (See Papaver.)

\***POTENTILLA nepalensis**. Silvery strawberry-like foliage and branching stems with brilliant cherry-colored flowers.

\***pyrenaica**. A choice variety from the Pyrenees with golden blossoms one or two to the stem.

\***tridentata**. A low-growing species with dark green leathery leaves and large white flowers.

\***PRIMULA acaulis (vulgaris)** (Common English Primrose). Bright lemon-yellow and fragrant. 6 to 9 in. April, May. 3 for \$1.25, 10 for \$3.50.

\***auricula alpina**. Thick leaves covered with down. Round flowers borne in clusters in many colors. 6-8 in. May, June.

\***polyantha**. The popular Polyanthus, comprising flowers of many colors. 6-12 in. May, June.

\***PRUNELLA Webbiana**. Dense spikes of rich lavender flowers July to September. Masses of beautiful foliage.

\***PULMONARIA saccharata**. Handsome silver and green-marbled foliage. Rich blue flowers. 12 in.

**PYRETHRUM roseum**. Single mixed varieties. Useful for cutting and borders. 24 in. May, June.

**RUDEBECKIA laciniata, Golden Glow**. Masses of double, golden-yellow flowers. 6 to 8 ft. Aug., Sept.

**purpurea** (Purple Coneflower). (See *Echinacea purpurea*.)

**speciosa (Newmanni)**. Dark orange-yellow flowers; fine for cutting. 2 ft. June-Oct.

**subtomentosa**. Densely branched masses of brilliant lemon-yellow flowers with dark purple centers. 4 to 5 ft. July-Oct.

**SALVIA azurea grandiflora**. A Rocky Mountain species, with pretty sky-blue flowers. 3 to 4 ft. Aug., Sept.

**Pitcheri**. (Blue Meadow Sage). Flowers of deep indigo-blue are produced in great profusion on slender stalks. 3 to 4 ft. high. Blooms from August to September when flowers are scarce. 3 for \$1.20, 10 for \$3.50.

All plants, except where noted, 3 for 90c; 10 for \$2.50. Not less than 3 of 1 variety sold. Write for special prices for plants in quantity.

- \***SAPONARIA** *ocymoides*. (Rock Soapwort). A rock plant, with many small, bright crimson flowers. 1 ft. May-July.
- \***SANTOLINA** *incana* (Lavender Cotton). Evergreen perennial with silver-white foliage. 1 ft.

**SAXIFRAGA** (*Megasea*).

- \***cordifolia**. These will thrive in any kind of soil and in any position. Grow about 1 foot high, and are admirable for the front of the border or shrubbery, forming masses of handsome, broad, deep green foliage. Spikes of pink flowers. Spring.
- \***crassifolia**. 12 to 15 inches. April to June. Showy and spreading. Drooping masses of pink flowers high above the large, clustered leaves. A fine rock plant.
- \***decipiens** (Crimson Moss). Dwarf, mossy plants bearing white flowers in May and June. The green foliage turns a bright crimson in Winter. 4 inches high. Splendid rock plant. Above Saxifragas, 3 for \$1.25, 10 for \$3.50.

**SCABIOSA** *caucasica*. Beautiful, soft lilac flowers, vigorous grower. 2 to 3 ft. June-Aug.

- alba**. Very rare; pure white; 2 to 3 ft.

The above two varieties, 3 for \$1.25, 10 for \$3.50.

**Isaac House Hybrids**. A fine large-flowered strain; a great improvement over the old type. 3 for \$1.25, 10 for \$3.50.

**japonica**. Divided leaves, branching habit. Lavender-blue. 3 ft. June to Aug.

\***SEDUM** *acre* (Golden Moss, Stonecrop). Flowers bright yellow. 2-3 in. May-July.

- \***album**. Foliage green; flowers white. 2-3 in.
- \***anglicum**. Neat pretty trailer with white or pale pink flowers. 3-4 in.
- \***pruniatum** *Fosterianum*. One of the best, with glaucous red-tinted foliage. 3-4 in.
- \***reflexum**. A rapid growing type. Yellow flowers, feathery green foliage. 6-7 in.
- \***Sieboldi**. Bluish gray foliage, rose-pink flowers. 6 in. Aug. and Sept.
- \***spurium** (*stoloniferum*). A good type of fast growth with white or yellow flowers. 6-7 in.
- \***spectabile** (Stonecrop). Large heads of pink flowers. Fine border plant. 1½ ft. Aug.-Sept.

\***SEMPERVIVUM** *arachnoideum*. (Spider Houseleek). Curious and interesting plants which make small rosettes of leaves. Flowers red. 6 in.

\***tectorum** (Roof Houseleek). Broad rosettes of green leaves tipped red, and red flowers. 8-12 in.

\***SHORTIA** *galacifolia*. Oval-shaped foliage turning crimson in autumn. White flowers 1 in. across.

\***SILENE** *alpestris*. Good rock plants closely allied to the Pink family. Close cushions of foliage with pure white blossoms 3 to 4 in. high.

\***SILENE** *Schafta*. Showy rose-colored flowers. Leafy tufts.

\***SOLDANELLA** *alpina*. A rock garden gem forming large mats of leathery leaves from which spring violet-blue fringed blossoms in early spring. 3 for \$2.10, \$6.00 for 10

**SPIREA**. (Also see *Astilbe*.)

**aruncus**. 4 feet. June. Produces long, feathery panicles of white flowers, forming graceful plumes.

**filipendula** (Dropwort). Numerous corymbs of white flowers on stems 15 inches high. June and July; pretty fernlike foliage.

**ulmaria fl. pl.** The well-known double "Meadow Sweet." Creamy-white flowers

**Japonica Varieties.**

**Gladstone**. Feathery plumes of pure white flowers. 2 ft. June.

**Peach Blossom**. Good pink. 2 ft. June.

**Queen Alexandra**. An early flowering variety of soft creamy-pink. 2 ft. June.

Above Japonica varieties, 3 for \$1.50, 10 for \$4.50.

\***STACHYS** *lanata*. Purple spikes of flowers; soft silvery foliage. 1½ ft. June, July.

\***STATICE** *latifolia* (Sea Lavender). Fine spreading panicles of lavender flowers.

**STOKESIA** *cyanea* (Cornflower Aster). Flowers 3 to 4 in. across, of a fine sky-blue. 2 ft. July-Oct.

—**alba**. A white form of the above.

**SWEET WILLIAM**. (See *Dianthus*.)

\***TEUCRIUM** *chamaedrys*. A tiny shrub-like plant with glossy dark green leaves and bright pink flowers. Also excellent for edging. 3 for \$1.20, \$3.00 for 10, \$25.00 per 100.

**THALICTRUM** *aquilegifolium* (Meadow Rue). Graceful foliage and masses of pure white flowers. 1 to 3 ft. May-July.

**adiantifolium**. Leaves resemble those of the maidenhair fern; flowers yellow. 1 ft. June, July.

**dipterocarpum**. One of the handsomest *Thalictiums*, with graceful flowers on stems 4 ft. high; rosy purple, citron-yellow anthers. Aug., Sept. 3 for \$1.25, 10 for \$3.50.

**THERMOPSIS** *caroliniana*. A fine plant with clover-like foliage; long spikes of bright yellow, pea-shaped, lupine-like flowers. 4 ft. June, July. 3 for \$1.25, 10 for \$3.50.

\***THYMUS** *serpyllum* (Creeping Thyme). A creeping evergreen plant much prized for edging and rockwork. Tiny lilac flowers. 6 in. July.

\***serpyllum citriodorus** (Scented Thyme). With tiny pink flowers and sweet foliage. 4 in. July, Aug.

\***vulgaris** (Common Thyme). Small lilac flowers with fragrant foliage. 6 in. June, July.

All Thymes above: 3 for \$1.25, 10 for \$3.50.

\***TIARELLA** *cordifolia* (Foam Flower). Tufts of broad leaves and racemes of creamy-white flowers. 12 in.

**TRADESCANTIA** *virginiana* (Spiderwort). Long, grass-like leaves, violet flowers. 2 ft. May-Aug.

—**alba**. White flowers. 2 ft. May-Aug.



Saponaria Ocymoides



Scabiosa Caucasica



Spirea Aruncus

All plants, except where noted, 3 for 90c; 10 for \$2.50. Not less than 3 of 1 variety sold. Write for special prices for plants in quantity



Trollius Europaeus



Veronica Incana

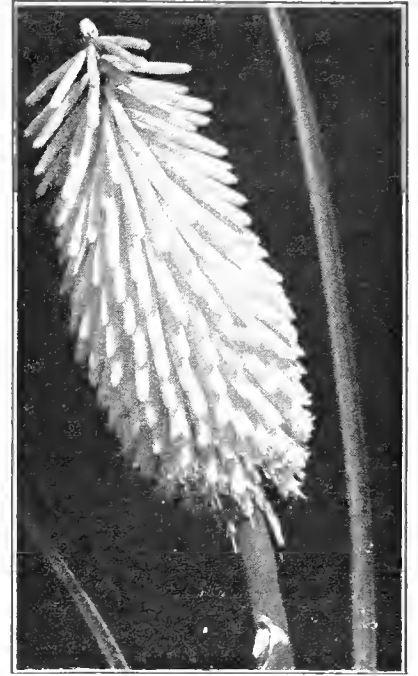

Tritoma grandis

**TRILLIUMS.** (See Fall Catalog).

**TRITOMA grandis (Pfitzeri).** The freest flowering of all; orange-scarlet, shading to salmon-rose at the edge. 2 to 3 ft. Aug., Sept.

**rufa.** The flowers are smaller and more dainty than the old Tritoma; they make excellent cut flowers. Very free-flowering, blooming from June until frost. 3 for \$1.00, 10 for \$3.00, 100 for \$25.00.

**rufa hybrids.** Charming hybrids of this new race of Tritomas varying in color from all shades of red and yellow to white. 3 for \$1.25, 10 for \$3.50, 100 for \$30.00.

**TROLLIUS europaeus (European Globe Flower).** Lemon-colored, buttercup-like flowers, 1 to 1½ in. across. 2 ft. May-June.

**Ledebouri, Golden Queen.** Exceptionally fine large flowers. June to Oct. 3 for \$1.50, \$4.50 for 10.

**Orange Globe.** A profuse bloomer, of robust growth; large orange flowers; very fine. 2 ft. May, June. All Trollius, 3 for \$1.50, 10 for \$4.50.

\***TUNICA saxifraga.** Beautiful little prostrate rockery plant with rose-colored flowers.

**VALERIANA officinalis (Hardy Garden Heliotrope).** Fragrant, light pink flowers. 3 to 5 ft. June, July.

**VERBASCUM (Mullein). Harkness Hybrids.** Picturesque plants flowering over a long period with large flowers of various colors. 6 ft. Aug.

**olympicum.** Yellow flowers. Very attractive variety. 8 ft. May, June.

**thapsiforme (densiflorum).** Large, yellow flowers. 2 to 5 ft.

**VERONICA (Speedwell).**

**incana.** Deep blue flowers with silvery foliage. 1 ft. July, Aug.

**longifolia subsessilis.** Blue. Attractive; blooms until late fall. 2 ft. Aug., Sept. 3 for \$1.25, 10 for \$3.50.

\***rupestris.** An excellent plant for carpeting rockeries with dense spikes of blue flowers. 4 in. May, June.

**spicata.** Spikes of blue flowers. 1½ ft. June, July.

**VINCA (Periwinkle or Trailing Myrtle).**

**minor.** A trailing, evergreen plant, used extensively for carpeting the ground under shrubs or trees where it is too shady for grass or other plants to thrive.

\***VIOLA**

**odorata, Single Russian.** (Sweet Violet). An excellent hardy variety for herbaceous borders, flowers dark blue on long stems. 6-8 in. May to Oct.

**cornuta (Tufted Pansies).**

\***Admiration.** Soft purple, dark blotched.

\***G. Wermig.** This is a true Viola cornuta, with large blue flowers.

\***lutea splendens.** Golden yellow.

**VIOLA—**

\***White Perfection.** White.

\***Jersey Gem.** A valuable bedding Viola, with good stems, on which are pure violet flowers. May to October.

**YUCCA filamentosa (Adam's Needle).** Pyramidal clusters of creamy flowers. 4 to 6 ft. June, July. 2 years.

**All plants, except where noted, 3 for 90c, 10 for \$2.50. Not less than 3 of 1 variety sold. Write for special prices for plants in quantity.**

**SEEDS OF PLANTS FOR ROCK GARDENS**

Being frequently asked to recommend seeds of plants not necessarily alpine—suitable for use in American rock gardens, we have compiled the following lists for ready reference. All those offered are of easy culture and can be relied upon to give greater general satisfaction than is usually obtained with the rarer and more difficult alpine.

While the veteran rock gardener may decry the use of annuals in the rock garden, we stress their utility for making a quick showing either in temporarily replacing losses or for immediate effect in newly constructed rock gardens.

**SEEDS OF PERENNIALS**

- |                                |                          |
|--------------------------------|--------------------------|
| Adonis vernalis                | Cowslips                 |
| Alyssum saxatile               | Dianthus plumarius       |
| Alyssum saxatile, Silver Queen | Edelweiss                |
| Anemone coronaria              | Erysimum pulchellum      |
| Aquilegia glandulosa           | Erinus alpinus           |
| Aquilegia Skinneri             | Heuchera sanguinea       |
| Arabis alpina                  | Linaria cymbalaria       |
| Armeria                        | Linum perenne            |
| Asperula odorata               | Myosotis (in variety)    |
| Aubrietia (in variety)         | Platycodon Mariesi       |
| Auricula                       | Polyanthus (in variety)  |
| Bellis                         | Primula Beesiana         |
| Callirhoe involucrata          | Primula japonica         |
| Campanula carpatica            | Primroses (in variety)   |
| Carnation (dwarf Vienna)       | Thalictrum adiantifolium |
| Cerastium tomentosum           | Viola odorata            |
| Cheiranthus Allioni            | Viola "Jersey Gem"       |
| Cheiranthus linifolius         |                          |

**SEEDS OF ANNUALS**

- |                    |                          |
|--------------------|--------------------------|
| Abronia            | Nemesia compacta         |
| Ageratum           | Pansy (in variety)       |
| Alyssum            | Petunia (dwarf)          |
| Candytuft          | Phacelia                 |
| Dianthus           | Phlox Drummondii (dwarf) |
| Eschscholtzia      | Portulaca                |
| Globe Amaranth     | Sanvitalia               |
| Ionopsidium        | Tagetes                  |
| Lobelia            | Verbena                  |
| Marigold (dwarf)   | Viola (in variety)       |
| Mesembryanthemum   | Viscaria                 |
| Mignonette (dwarf) |                          |

All plants, except where noted, 3 for 90c; 10 for \$2.50. Not less than 3 of 1 variety sold. Write for special prices for plants in quantity.

# Garden Chrysanthemums

## NEW EARLY KOREAN HYBRID CHRYSANTHEMUMS

The following Korean Hybrids were selected from thousands of seedlings, not alone for the novel color tones in many of them and their variations in form, but most particularly because of their flowering ten days to two weeks earlier than the Korean crosses heretofore offered.

The varieties here offered will begin flowering in early September and continue well through October.

**NIOBE.** A vigorous healthy plant of dwarf compact habit. Flowers over 2½ in. in diameter, of a clear glistening white with yellow disc, are freely produced, fully covering the plant.

**SAPPHO.** Compact dwarf plant covered with good-sized pure yellow single flowers.

**JUNO.** Very dwarf compact plant, producing an abundance of single flowers opening a coppery-red, and fading with age to a salmon-flesh.

**VESTA.** A plant of medium height and great vigor literally covered with flowers over 2½ in. in diameter, of a deep golden orange shade, almost a duplex.

**NYSSA.** A large rather tall upright plant growing 2½ to 3 ft. in height and producing a great abundance of single flowers 3 in in diameter. The color is very clear rosy-lilac.

**FORTUNA.** Very vigorous plant of medium height and covered with unique curly petaled oxblood-red flowers 3 to 4 in. in diameter. Very striking.

**THALIA.** A compact bushy plant growing 18 to 24 in. in height. The duplex flowers are of a lively orange shade and excellent form.

**PSYCHE.** Wonderfully dainty 4 to 5-in. single blooms are produced, with wiry stems, on strong healthy plants of medium height. Color, a clean lively shell-pink.

**CLIO.** Dwarf compact plant of pleasing habit producing masses of deep carmine-rose duplex flowers.

**HESTIA.** The nicely-formed semi-double flowers are very freely produced on compact bushy plants of medium height. The color is a very delicate rose-pink with a white halo around the small yellow disc.

Any of above—3-in. pot plants—ready April 1—3 for \$1.50, doz. \$5.00.

One each of ten above varieties—\$3.00.

## CHRYSANTHEMUM MORIFOLIUM

A very congenial companion to the early flowering Korean Hybrids is this beautiful species from the Orient.

A vigorous free-branching plant of very symmetrical habit producing hundreds of one- to one-and-a-half-inch single pink flowers beginning about the middle of September.

Wonderfully useful either in the border or rockery.  
3 for 90c, doz. \$2.50.



Korean Hybrid Chrysanthemums

## CUMMING'S KOREAN CHRYSANTHEMUMS

These varieties have created quite a lot of interest because of their freedom of bloom, vigorous habit, and beautiful pastel shades

**APOLLO.** The most profuse bloomer of them all. A sparkling combination of bronze, red and gold, suffused with glowing salmon. Blooms about October 12, and grows 2½ feet high. Flowers 2 inches across.

**CERES.** Old gold blended with chamois-yellow and dusted with coppery bronze. A handsome plant which blooms about October 10. Height 2 to 2½ feet.

**DAPHNE.** A lovely large flower almost matching the color of Daphne cneorum—a splendid pink with a sheen of lilac-rose. Flowers 3½ inches across. Blooms about October 12. Height, 2 to 2½ feet.

**DIANA.** A charming color blend of Chatenay rose-pink mingled with lilac-rose and soft salmon. Has triple rays of petals. Blooms about October 12. Height, 2 feet.

**MARS.** Deep amaranth-red changing to wine-red overlaid with a velvety sheen. The latest to flower, about October 15. Height, 2 to 2½ feet.

**MERCURY.** (Plant Patent No. 58). Bronze-red on opening, changing to coppery bronze when maturing. Nicely formed, showy blooms about 3 inches across. Begins blooming about October 5. A splendid well-lasting cut flower. 2 feet.

3-inch pot plants of above—3 for 90c, \$25.00 per 100.

## OTHER HARDY CHRYSANTHEMUMS WORTHY OF SPECIAL NOTE

**AMELIA.** (Pink Cushion). A very compact, free-flowering and very early soft rose small Aster.

**CAVALIER.** Very graceful single with small flowers of a deep wine color, very freely produced.

**GRANNY SCOVILLE.** A very large decorative or Aster-flowered sort. Perfectly double blooms of a warm coral-bronze.

**JEAN TREADWAY.** Unusually popular pink Aster.

**SENSATION.** A sensational and strikingly attractive single yellow in which every petal is tipped with scarlet.

**THE CHIEF.** The deep double blooms are bright rich scarlet with a golden reverse giving the flower an artistic appeal with their unusual showy color combination. A beautiful large flower.

**SUNBRIGHT.** A pure yellow single that glitters and scintillates in the sun and under artificial light

3-inch pot plants of above—doz. \$2.50, 100 for \$20.00.

## KOREAN HYBRID CHRYSANTHEMUM SEED

Plants of this variety are easily grown from seed and if sown early will bloom in the fall of the same year as sown. The range of colors on these hardy, bushy plants is most impressive. Pocket \$1.50.

For other varieties of Chrysanthemums, see page 68



# Hybrid Tea or Everblooming Roses

## Suggestions for Spring Planting of Roses

The soil should be thoroughly cultivated and a liberal supply of rotted manure added. In planting, dig a hole sufficiently large to accommodate the roots when spread out on the bottom of the hole. In filling in the soil, shake the plant lightly in order that the soil may mix between the roots. Fill in the soil and firm it in order that the plant may be solid. Be sure to see that the lower parts of the lower branches are below the surface of the soil. Do not plant in a mound, the surface should be level. Cut back the branches to within 4 to 6 inches of the surface of the ground. With this treatment the best results may be obtained.

## PINK AND ROSE SHADES

- Briarcliff.** One of the most popular. Brilliant rose-pink and fragrant.
- Charles P. Kilham.** Large blooms of brilliant orange-pink, suffused with yellow. Foliage resistant to mildew, vigorous, upright.
- Edith Nellie Perkins.** Large pointed flower, salmon-pink, outside dark coppery-red. Good grower with few thorns.
- Jonkheer J. L. Mock.** Carmine, changing to imperial pink. A variety of distinct merit.
- Lady Alice Stonley.** Deep coral-rose on the outside of the petals, pale flesh on the inside.
- Lady Ashtown.** Pale carmine-pink, shading to golden yellow at base of petals.
- Los Angeles.** A luminous flame-pink, toned with coral and shaded with translucent gold.
- Morganst McGredy.** Brilliant cranial red; a marvelous color, very prolific.
- Miss Rowena Thom.** Enormous buds and blooms of fiery rose, borne on long strong stems. Profuse and continuous bloomer, vigorous.
- Mme. Butterfly.** Bright pink, apricot and gold. Large buds and flowers.
- Mme. Nicholas Aussel.** Salmon-pink.
- Mrs. Henry Bowles.** A dependable variety, cerise-pink, with lighter shades.
- Mrs. Henry Morse.** A lovely pink, shaded salmon, deeper at the base.
- Mrs. W. E. Nickerson.** Long buds, soft silvery-pink shaded old gold and salmon.
- Radiance.** Beautiful carmine-rose flushed with copper; large round flowers.
- Souvenir de Georges Pernet.** Deep pink buds opening to orange-pink flowers of immense size.
- Souvenir de Mme. C. Chambard.** Enormous perfectly shaped flowers of striking salmon-pink.

## SCARLET, CARMINE AND CRIMSON SHADES

- Ami Quinard.** Semi-double blackish crimson flowers, free-flowering, upright growth.
- Charles K. Douglas.** Fine long-pointed buds opening to large flowers of crimson-scarlet.

- Etoile de France.** A soft, velvety crimson, with a vivid shade of cerise.
- Etoile de Hollande.** Brilliant red bloom, fine size, very fragrant. A splendid rose.
- McGredy's Scarlet.** Brilliant scarlet, strong grower.
- W. E. Chaplin.** Glowing crimson of handsome form.
- Red Radiance.** Color deep red. The enormous globular flowers are borne on heavy canes.
- Syracuse.** Outstanding bright crimson.

## YELLOW AND COPPER SHADES

- Autumn.** Burnt-orange.
- Betty Uprichard.** An indispensable bedding variety; copper-red buds opening to orange-carmine.
- Duchess of Wellington.** Flowers saffron-yellow, which become deep coppery yellow.
- Duchess of Luxembourg.** Excellent golden-yellow.
- Mevrouw G. A. Van Rossem.** Orange and apricot.
- Mrs. Aaron Ward.** The color is a distinct Indian yellow, and as the flowers expand, they shade lighter to the edges.
- Mrs. Erskine Pembroke Thom.** Bright canary-yellow, one of the best yellows, does not fade.
- Mrs. Pierre S. Dupont.** Well-shaped, golden yellow flowers, on compact plants.
- Padre.** Copper-scarlet with bright yellow at base.
- President Herbert Hoover.** Maroon, orange and gold.
- Rev. F. Page Roberts.** Copper-red buds of great length, opening to golden yellow.
- Sunkist.** Rich orange-copper.
- Talisman.** Brilliant red and gold buds, opening to blooms of scarlet-orange. Tall and vigorous.
- Ville de Paris.** Large globular flowers of clear yellow; tall and wiry with good foliage.
- Wilhelm Kordes.** Long-pointed buds of deep golden-salmon, suffused copper and veined with red; very fragrant.

## PURE WHITE AND WHITE SHADES

- Kaiserin Auguste Viktoria.** Considered best white. An old standard variety with creamy white buds opening to perfectly formed blooms of snowy white.
- Konigin Louise.** Large bud and flower; double, high centered, very lasting white.
- Mrs. Franklin Dennison.** Large white blooms of unusual substance, sometimes lightly shaded pink.
- Any of the above varieties—75c each, \$7.00 for 10, \$65.00 per 100.**  
All strong 2-year old field grown dormant plants.

Dormant Roses can be supplied till May 1.  
From then on **Potted Roses at \$1.00 each; \$9.00 for 10; \$85.00, 100.**  
Varieties not listed can be supplied at current prices.



**HYBRID PERPETUAL AND MISCELLANEOUS ROSES**

- Frau Karl Druschki.** Fine snow-white; vigorous.
- General Jacqueminot.** Brilliant scarlet-crimson.
- Mrs. John Laing.** Immense blooms of soft clear pink. A strong grower.
- Paul Neyron.** Deep rose; largest of all Roses.
- Ulrich Brunner.** Bright, cerise red; flowers large.  
The above—Each 75c, 10 for \$7.00.
- Rosa rugosa.** Single flowers, shades of pink. Particularly suited for planting near seashore and other exposed places. 18 to 24 in., 60c each, \$5.50 for 10; 2 to 3 ft., 80c each, \$7.50 for 10.
- Rosa hugonis.** Light yellow flowers along slender branches. Not suitable for planting in rose beds, but invaluable for single specimens or among shrubs. 18 to 24 in., 80c each, \$7.50 for 10; 2 to 3 ft., \$1.00 each, \$9.00 for 10.

**STANDARD ROSES**

We can supply many of the leading varieties in standard or tree form. Each \$3.50.

**CLIMBING ROSES**

- B'aze.** An everblooming scarlet-red. Very hardy and vigorous. Each \$1.00.
- Climbing American Beauty.** Fragrant flowers of a rich crimson color.
- Dr. W. Van Fleet.** The long-pointed buds are of a rich flesh-pink on long stems; vigorous grower.
- Emily Gray.** Golden yellow flowers like Marechal Niel. Very fragrant. Needs protection during the winter.
- Golden Climber (Mrs. Arthur Curtiss James).** Plant Patent No. 28. Vigorous habit. Flowers large, unfading golden yellow. Best hardy yellow-flowering climbing Rose. \$1.00 each.
- Mary Wallace.** Large double vivid pink flowers, strong grower, very hardy.
- Mme. Gregoire Staechelin.** Large delicate pink flowers stained crimson outside, on long stems. Disease resistant.
- Paul's Scarlet Climber.** It is a vivid scarlet, shaded with bright crimson.
- Primrose.** Rich primrose-yellow flowers in clusters, glossy foliage, vigorous.
- Roserie.** A thornless Rose of deep pink.
- Silver Moon.** Semi-double, pure white flowers with bright yellow stamens; very profuse bloomer.
- The New Dawn.** Everblooming Climbing Rose. The color is a soft blush pink. Each \$1.50.

The above Roses—75c each, 10 for \$7.00, \$65.00 per 100, except where noted.

**DWARF POLYANTHA ROSES**

- The Polyanthos are a charming class of everblooming Roses, of a dwarf, bushy habit.
  - Gloria Mundi.** Large clusters of striking reddish orange buds and blooms of most amazing color.
  - Ideal.** Dark scarlet, shaded black; profuse bloomer in compact bushes.
  - Miss Edith Cavell.** A brilliant scarlet color.
  - Mrs. W. H. Cutbush.** Soft pink flowers borne in clusters.
  - Orleans.** Brilliant geranium-red, tinted pink with creamy-white centers.
  - Triomphe Orleansais.** A bright, cerise-red
- The above Polyantha Roses—75c each, \$7.00 for 10, \$65.00 per 100.

Varieties not listed can be supplied at current prices. For New and Patented Varieties of H.T. and Climbing Roses, see page 8.

**GREENHOUSE ROSES**

- The Roses we offer for greenhouse culture are grown by reliable growers on grafted stock only. We guarantee fine, healthy stock will be sent on all orders entrusted to our care.
- Briarcliff.** The color is more brilliant than Columbo, being a true rose-pink.
- Double White Killarney.** The best white.
- Joanna Hill.** A clear yellow, deepening at the center. The best yellow.
- Mme. Butterfly.** Bright pink, apricot and gold. A glorified Ophelia
- Premier Supreme.** Rose-pink, free and easy grower.
- Rapture.** An exquisite salmon shade, deeper than Butterfly, with the some golden flush at the base of petals.
- Talisman.** The outstanding Rose. Color a combination of gold, apricot, yellow and deep pink or old rose.
- Templar.** A clear bright red; very fragrant.
- Grafted stock. Varieties above, 2 1/4-in. pots—100, \$45.00; 3-in. pots, 100, \$60.00.**
- Better Times.** A brilliant cerise-pink with a silvery sheen. Very firm texture with a clean heavy foliage. An outstanding rose. 2 1/4-in. pots, \$60.00 per 100.
- Souvenir.** A clear yellow sport of Talisman with growth similar in every way to parent. 2 1/4-in. pots, \$60.00 per 100.

Greenhouse Roses are ready from middle of February on, and if ordered in advance will be shipped in due season for planting or on date specified.



Frau Karl Druschki



Dwarf Polyantha Rose



Primrose, Climbing Rose

# Hardy Vines and Climbers

From a utilitarian as well as an ornamental viewpoint, hardy vines are most desirable. For beautifying pergolas, fences or rough banks nothing is quite so satisfactory. Our offerings embrace the choicest as well as the more reasonably priced varieties.

Field grown vines may be shipped in Spring or Fall; pot grown specimens are available throughout the year.

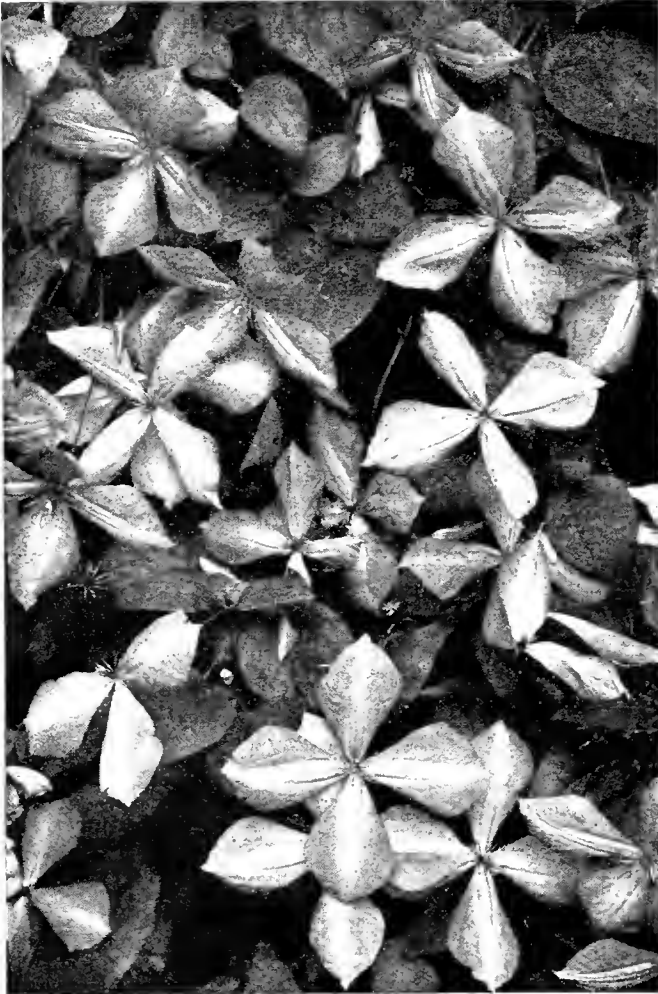

Clematis Jackmani

- ACTINIDIA arguta.** Shining, dark green foliage. Flowers white, with purplish center.  
2 years .....\$1.00 each; \$7.50 for 10
- AKEBIA quinata.** Numerous bunches of violet brown flowers; does best in sunny places.  
2 years .....60c each; \$5.00 for 10
- AMPELOPSIS heterophylla.** Well adapted for covering rocks and low trelliswork.  
3 years .....75c each; \$6.50 for 10
- quinquefalia** (Virginia Creeper). Very large, green foliage, brilliant scarlet in the fall.  
2 years .....50c each; \$4.50 for 10
- Engelmanni.** Similar to the preceding, with smaller and more dense foliage.  
3 years .....60c each; \$5.00 for 10
- tricuspidata Lawi** (Lowi) (New Japanese Ivy). The small, prettily lobed foliage changes to a brilliant crimson in autumn.  
Pot grown plants .. \$1.00 each; \$9.00 for 10
- Veitchi** (Japanese or Boston Ivy). Rapid growing vine, handsome green foliage, assuming charming sun tints in the fall.  
Field grown plants, 2 years.....\$7.00 for 10  
Pot grown plants.....80c each; \$7.50 for 10
- ARISTOLOCHIA Sipha** (Dutchman's Pipe). A vigorous and rapid flowering climber .....\$1.50 each
- BIGNONIA radicans** (Common Trumpet Vine). Brilliant orange-scarlet flowers in July and August.....60c each; \$5.00 for 10
- grandiflora.** The flowers have a distinct apricot shading and measure three inches across. The long racemes carry twelve or more flowers. Strong grafted flowering plants. \$3.00 each.
- CELASTRUS scandens** (False Bittersweet). A native vine, of rapid growth, with large leaves and yellow flowers.  
Field grown plants. ....75c each; \$6.50 for 10
- CLEMATIS.** Beautiful and attractive vines.  
**Jackmanii.** One of the best; large, rich, velvety purple flowers in profusion. \$1.50 each  
**Henryi.** Large, creamy white, fine form. \$1.50 each.  
**Mme. Edouard Andre.** Bright red flowers. Pot grown plants. \$1.50 each.  
**paniculata** (Japanese Virgins Bower). The white flowers are very pretty, fragrant and resemble snowflakes in late Summer.  
Field grown plants.....50c each; \$4.50 for 10
- EUONYMUS radicans.** Very hardy, dense growing trailing vine; dull green leaves, with whitish veins.  
Field grown plants.....60c each; \$5.00 for 10
- variegatus.** Fine vine, with clinging tendrils. Compact, variegated, small leaves.....75c each; \$7.00 for 10
- vegetus.** Has round leaves and produces an abundance of showy red fruits with yellow pods.  
2 years .....60c each; \$5.00 for 10  
3 years .....75c each; \$6.00 for 10
- HEDERA helix** (English Ivy). This is the popular, small-leaved variety and has proved perfectly hardy.  
Pot grown plants, 4 in.....65c each; \$6.00 for 10
- LONICERA Halliana** (Hall's Japanese Honeysuckle). A strong grower and constant bloomer. A choice variety.  
2 year plants.....\$3.50 for 10; \$30.00 per 100
- sempervirens** (Trumpet Honeysuckle). One of the best varieties. Its deep crimson flowers are borne profusely throughout the summer followed by scarlet berries.  
Field grown .....75c each; \$5.00 for 10
- LYCIUM Chinense** (Chinese Matrimony Vine). A vigorous climber, branching freely, bright purple star-shaped flower followed by brilliant scarlet berries. Fine for banks or retaining wall.  
3 years .....60c each; \$5.00 for 10
- POLYGONUM auberti** (Silver Lace Vine). A useful climbing plant, perfectly hardy, a strong grower, covering itself with a sheet of snowy white flowers.  
Pot grown .....\$1.50 each; \$12.00 for 10
- PUERARIA Thunbergiana** (Kudzu Vine). A most remarkable rapid growing vine, unparalleled for ornament and shade. 50c each; \$4.50 for 10.
- SCHIZOPHRAGMA hydrangeoides** (Climbing Hydrangea). Has bright green, round leaves, and flowers similar to Hydrangeas.  
Pot-grown plants .....\$1.00 each
- TECOMA.** See *Bignonia*.
- WISTERIA sinensis (chinensis)** (Chinese Wisteria). Flowers sky-blue, in long, pendulous clusters. 2 years....75c each; \$7.00 for 10
- alba (chinensis alba)** (White Chinese Wisteria). A choice variety with white flowers.  
4 years .....\$1.50 each  
5 years .....\$2.00 each
- multijuga.** A Japanese variety with exceptionally long sprays of purple blossoms.  
2 years .....85c each; \$7.50 for 10

## MARSHALL'S TRAINED FRUIT TREES

In our constant effort to offer "Everything good for every good garden," we have made arrangements with a specialist to grow trained fruit trees for us.

We issue a special folder on Trained Fruit Trees—Sent upon request. Apples, Apricots, Nectarines, Peaches, Pears, Plums.

### PRICES

	Each
SINGLE CORDON, Vertical..	\$ 2.75
HORIZONTAL CORDON..	5.00
HORIZONTAL CORDON, Single for Corners.....	4.00
U SHAPED, 4 to 5 Feet...	5.00
U SHAPED, 6 to 8 Feet...	7.00
DOUBLE U or PALMETTE VERRIER, 4 to 5 Feet..	8.00
DOUBLE U or PALMETTE VERRIER, 6 to 8 Feet..	10.00
SIX ARMED VERRIER	\$15.00 to 18.00
EIGHT ARMED VERRIER	\$20.00 to \$24.00.

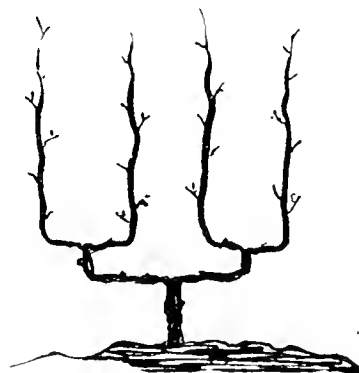

Double U-Shaped

FAN SHAPED TREES in several varieties, \$10.00 to \$20.00  
No charge for packing when cash accompanies order.  
All shipments sent by express, charges collect.

# Small Fruits

## BLACKBERRIES

**Snyder.** The reliable Blackberry for the North. Hardy and prolific.  
**Alfred.** Originated in Michigan, perfectly hardy at thirty degrees below zero. Immensely productive. \$2.50 for 25; \$7.50 per 100.

## CURRENTS

**Foy's Prolific.** A popular red Currant; very large and sweet. Productive.  
**Perfection.** Bush vigorous, hardy and very productive; berries and clusters large; color bright red.  
**White Grape.** An excellent white variety; of large size; very sweet. Strong, 2-year-old bushes, \$4.00 for 10, \$30.00 for 100.

## GOOSEBERRIES

**Josselyn.** Large red fruit.  
**Downing.** Fruit greenish yellow. 2-year-old bushes, \$4.00 for 10, \$35.00 per 100.

## GRAPES

### BLUE AND BLACK VARIETIES

**Concord.** Fine black variety; splendid flavor; reliable and productive; one of the most popular.  
**Hubbard.** Black, sweet and delicious. Berries and bunch large.  
**Moore's Early.** Bunch medium; berry very large, with heavy blue bloom; good quality.

### RED VARIETIES

**Brighton.** Flesh rich, sweet and of the best quality; ripens early, with the Delaware. Very productive.  
**Coco.** Large, wine-red in color, bunches good size and extra good quality.  
**Catawba.** A late ripening red variety of excellent flavor.

### WHITE VARIETIES

**Champagne.** Very large amber berry. Fine for dessert or making wine.  
**Niagara.** Bunch medium to large; berry large, roundish, uniform; skin thin, with a whitish bloom; flesh slightly pulpy; tender and sweet. Extra strong, 2-year-old canes, 50c each, \$4.50 for 10, \$40.00 per 100.

## RASPBERRIES

**Chief.** A red Raspberry from the West which ripens 10 days earlier than the Latham.  
**Cuthbert.** Deep rich crimson. An old variety but still a favorite.  
**Herbert.** Very large berry and a heavy cropper. It has a distinctly rich flavor and is all meat.  
**St. Regis.** (Perpetual). Bright crimson; large berries all through summer and fall.  
**The Latham.** Without doubt the best red Raspberry to plant today. Berries large in size and a rich red color, maturing very early. Canes hardy in northern latitudes.  
 Strong transplanted plants of any of the above varieties, 25 for \$3.50, 100 \$12.00.

### BLACK RASPBERRY

**Plum Farmer.** Very large, glossy berries; firm, juicy, and sweet. Heavy cropper. Strong plants, 25 for \$3.00, 100 \$10.00.



Niagara Grape

## STRAWBERRY PLANTS

For full description see our full catalog. Prices below are for layer plants.  
**Big Lote, Brandywine, Chesapeake, Early Jersey Giant, Gandy, Glen Mary, Marshall, New York, Premier, Senator Dunlop, Success, Washington, William Belt.** 25 for \$1.00, 100 for \$3.00.  
**Dorsett.** Recent introduction which is destined to lead the commercial field as an early berry. Large, firm, and of perfect quality. 25 for \$1.25, 100 for \$4.00.  
**Fairfax.** Early to midseason. Another recent introduction. Rich flavor, large and very firm. 25 for \$1.25, 100 for \$4.00.  
 If planted in spring, a good crop of fruit will be picked in fall.

### EVERBEARING STRAWBERRIES

**Mastodon.** "The Wonderberry." A heavy yielding everbearing strawberry of extraordinary size and delicious quality. 25 for \$1.00, 100 for \$3.50, 1000 for \$25.00.  
**Progressive.** Popular variety, with two large crops, one in June and the second which lasts throughout the fall. 25 for \$1.00, 100 for \$3.00, 1000 for \$20.00.

### POT GROWN STRAWBERRIES

We can supply Pot Grown Plants for delivery in July, August and September. These plants will give a good crop of berries the following year. A list of varieties and prices will be found in our fall catalog. Copy sent on request. **Pot grown plants are shipped by express only.**

**Peaches.** 3/4-in. strong, each \$1.00. In all standard varieties.

## Fruit Trees

**Apples and Pears.** 1-in. caliper, each \$2.00. 1 1/2-in. caliper, each \$3.00.

## Deciduous Hedge Plants

**Berberis Thunbergii.** (Japanese Barberry.) Ideal hedge plant. Green foliage turning scarlet in fall. Bright red berries.  
 12 to 15 in. ....25 for \$4.00, 100 for \$15.00  
 18 to 24 in. ....25 for \$6.50, 100 for \$24.00  
**Ligustrum Amurense.** Exceptionally hardy variety with handsome alive green foliage.  
 1 1/2 to 2 ft. ....25 for \$4.00, 100 for \$15.00  
 2 to 3 ft. ....25 for \$5.00, 100 for \$20.00

**Ligustrum Ovalifolium.** (California Privet). The most popular hedge plant. Retains its foliage until late in winter.  
 1 1/2 to 2 ft. ....25 for \$2.50, 100 for \$ 8.00  
 2 to 3 ft. ....25 for \$3.50, 100 for \$12.00  
 3 to 4 ft. ....25 for \$4.00, 100 for \$15.00

Prices of other deciduous shrubs suitable for boundary plantings or hedges will be quoted on request.

# Horticultural Tools and Requisites

**ANCHORS, Perfection Stay Wire.** For driving into the ground to hold tree wires. Doz. 75c, 100 \$5.00. Driving pins. Each 25c.

**APRONS, Gardener's Waterproof,** with bib; 34 in. long, 26 in. wide. Each \$1.50.

**Gardener's.** Blue drill with bib. Each \$1.00

**Gardener's Rubber.** Extra heavy. Each \$2.25.

**English Blue Serge.** With bib and pocket. Each \$4.00.

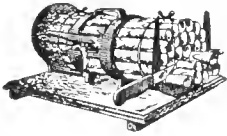

**Asparagus Buncher.** Useful on all private estates. It will not bruise the grass, easily and quickly adjusted to any length. Double band springs and knife guard. Each \$4.50.

**ASPARGUS KNIVES, American.** Can also be used as a weeder. Each 50c.

**BASKETS, English Garden.** Made of wood with strong wooden handle and feet. Handy for cut flowers and vegetables.

- No. 2. 11 1/2 in. long, 6 in. wide.....Each \$1.25
- No. 4. 15 in. long, 8 in. wide.....Each 2.00
- No. 6. 20 in. long, 10 in. wide.....Each 2.50
- No. 8. 26 in. long, 14 in. wide.....Each 3.75

**BASKETS, Farm.** Made with best oak splint, re-inforced with hoops. Handy for carrying leaves, rubbish, wood, coal, etc.

- 1 bushel size....Each \$2.00 2 bushel size.....Each \$3.00
- 1 1/2 bushel size....Each 2.50 3 bushel size.....Each 3.50

**BASKETS, Flower Gathering.** A well-made willow basket, 16 1/2 inches long, 3 inches deep in the center and 10 inches wide; 10-inch bow handle with holder for scissors on the side. Each \$3.50.

**BASKETS, Flower and Fruit.** A handy basket for gathering flowers, vegetables and fruits.

- Medium size, No. 2, 20x12x3 1/2 in.....Each \$1.00
- Large size, No. 3, 24x12x3 1/2 in.....Each 1.25

**BASKETS, Gardener's.** Adopted for gathering fruits, vegetables, flowers and other purposes around the garden or greenhouse.

Made with splint and bamboo bound with metal straps. Very strong and durable.

- No. 1 size 19 in. x 11 1/2 in. x 7 in. deep.....\$1.75
- No. 2 size 20 1/2 in. x 13 in. x 7 in. deep.....2.00
- No. 3 size 23 in. x 14 1/2 in. x 8 in. deep.....2.25
- No. 4 size 24 in. x 15 1/2 in. x 9 in. deep.....2.50
- No. 5 size 30 in. x 20 in. x 11 in. deep.....3.00

**BASKETS, Galvanized.**

Useful for vegetables, rubbish and all kinds of garden or farm work.

Also for carrying water, washing pots in, or mixing insecticides.

- No. 0. 3/4 bushel .....Each \$2.00
- No. 1. 1 bushel .....Each 2.50
- No. 2. 2 bushels .....Each 3.00

**BASKETS, Rustic Hanging.** Made from laurel roots, elegantly finished and rattan handle. They will stand severe weather, and with a little care are good for 10 to 12 years' wear. Each, 10 in. \$2.25, 12 in. \$2.50, 15 in. \$3.50

**BASKETS, Strawberry.** Useful for gathering strawberries and raspberries. Pint size, per 100, \$1.25, per 1000 \$11.00. One quart size, per 100 \$1.50, per 1000 \$12.00. 2 quart size, per 100 \$3.00. 3 quart size per 100 \$3.50. 4 quart size per 100 \$4.00.

**BASKETS, Hanging Wire.** Painted, 8 in. 35c, 10 in. 40c, 12 in. 50c, 15 in. 60c, 18 in. \$1.00, 21 in. \$1.35 each.

**BELLOWS POWDER.** (See Dusters).

**BEETLE CATCHERS, Ellisco.** This beetle trap is the result of scientific researches on the destruction of the Japanese Beetle. The vertical wing with perforated bait lure, attracts and holds even the most elusive of these beetles and holds them directly over the funnel into which they drop. Need be baited only once a season; bait sold separately, with full directions.

**Type 0.** A medium size trap, without mason jar. Each 40c. Bait 50c additional.

**Type 4.** Without mason jar. Each \$1.00. Bait, 1/2 pt. 50c additional.

**Acme Beetle Bait.** 1/2-pt. can for use with trap 50c, 1-lb. cans \$1.25.

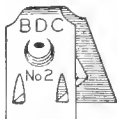

**BLAKE'S LEVER CLIPS.** For fastening Rose wires. Per box of 500 \$1.75.

**BULL DOG CLIPS.** Useful for fastening paper to pot plants, etc. Box. of 1000 \$1.00.

**BOXES, Corrugated.** Extra strong for shipping cut flowers.

Length	Width	Depth	Doz.	100
24 in.	8 in.	4 in.	\$2.50	\$17.00
28 in.	8 in.	5 in.	3.00	20.00
30 in.	12 in.	6 in.	3.50	25.00
36 in.	12 in.	8 in.	4.50	30.00
48 in.	14 in.	8 in.	5.00	35.00

Extra staples, 25c per 100.

**BOXES, Folding.** For cut flowers. Mist green color.

24 in. x 8 in. x 4 in. deep	\$1.50	\$ 9.00
28 in. x 8 in. x 5 in. deep	2.00	13.00
36 in. x 8 in. x 5 in. deep	2.50	16.00

**BOXES, Folding.** For cut flowers. Made of strong cardboard.

No.	Dimensions	Doz.	100
No. 2.	18 in. x 5 in. x 3 in. deep	\$0.75	\$ 4.00
No. 5.	21 in. x 7 in. x 3 1/2 in. deep	1.00	6.00
No. 8.	24 in. x 8 in. x 4 in. deep	1.50	8.00
No. 11.	28 in. x 8 in. x 5 in. deep	2.00	12.00
No. 19.	36 in. x 8 in. x 5 in. deep	2.50	15.00

**BOXES, Flower, Fiber or Leatheroid.** Used for shipping cut flowers or fresh vegetables by express. Lock and keys with each case.

Dimensions	Each
30 in. x 14 in. x 16 in. with 3 wicker trays	\$45.00
34 in. x 15 in. x 16 in. with 3 wicker trays	47.50
38 in. x 16 in. x 16 in. with 3 wicker trays	50.00

**BROOMS, Bamboo Sweeps.** Made with bamboo tips with bamboo handle. Each 60c, doz \$6.00.

**Birch.** For lawns. Each 75c.

**Kongo.** This broom is made with Coir Fiber with a metal case fastening. A fine broom for stable, garage, greenhouse work, also for cleaning gutters on roads. Each \$2.00.

**Tennis Court.** This broom is made with fiber and is used for dragging Tennis Courts to smooth them after use or rain. Made in 36-inch width. Each \$8.00.

**BRUSHES, Flower Pot, Cone-Shaped.** Made of bristle, wood handle. Each \$1.75.

**BULB PLANTER.** Hole In One. Makes a 3-inch hole, adjustable to any depth, handle 30 in. Each \$4.00. Small size with short handle. Each 50c.

**BURLAP.** For winter covering. 36 in. wide, 25c yd.; 42 in. wide, 28c yd.; 48 in wide, 30c yd.

Price subject to market change.

**CANES, Bamboo.**

	Doz.	100	1000
Green, 2 ft.	\$0.10	\$0.40	\$3.00
Green, 2 1/2 ft., Japanese	.10	.50	3.50
Green, 3 ft., Japanese	.10	.60	4.00
Green, 4 ft., Japanese	.15	.70	6.00
Green, 5 ft., Japanese	.20	1.00	7.50
Green, 6 ft., Japanese	.20	1.50	12.00
Natural, 6 ft., Japanese	.20	1.50	12.00
Japanese, heavy, 8 ft.	.40	2.50	20.00
Japanese, heavy, 10 ft.	.50	3.50	30.00

**CANES, Chinese Bamboo.**

	25	100
4 ft. long, 1/4 in. diam.	\$0.60	\$2.00
4 ft. long, 1/2 in. diam.	.75	2.50
6 ft. long, 5/8 in. diam.	1.50	5.00
8 ft. long, 5/8 to 3/4 in. diam.	1.75	6.00
9 ft. long, 3/4 to 7/8 in. diam.	2.75	11.00
6 ft. long, 1 1/2 in. diam. for Dahlias: doz.	\$4.00	30.00

Chinese Bamboo Tonkins are of even diameter throughout, stronger than wood stakes.

**CARNATION BANDS, Rubber.** 30c per oz.

**CARNATION STAPLES.** For split Carnations. 1000 50c.

**Cokely's Staples.** \$1.00 per 1000.

**Cokely's Pliers** for the above. Each \$3.00.

**CARNATION SUPPORTS.**

**"Model Extension".** Made with strong galvanized wire. Neat and durable.

	Doz.	100
Wire, 2 ring	\$1.25	\$7.50
Wire, 3 ring	1.25	8.50



**CARTS, "Handy" Garden.** This cart is well built of the best materials. The 36-inch wheels have 2-inch tires with 9 spokes. The axles and framework are of steel. It can be used for carrying milk cans, barrels of feed or water, fodder, feed and other purposes. The platform is 28 x 32 inches. Price \$18.00

CARTS—Continued.

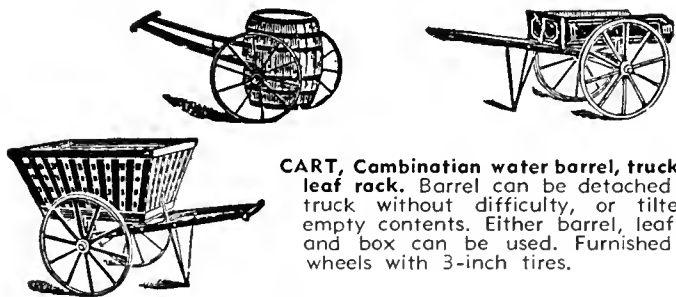

**CART, Combination water barrel, truck and leaf rack.** Barrel can be detached from truck without difficulty, or tilted to empty contents. Either barrel, leaf rack and box can be used. Furnished with wheels with 3-inch tires.

- Truck, with 3-in. tires and barrel.....\$24.00
- Truck without barrel, 3-in. tires ..... 18.00
- Truck and Leaf Rack.**
- Fig. 162 ..... 28.00
- Truck, Barrel, Leaf Rack and Cart.**..... 44.00
- Truck, Handcart and Barrel.**..... 30.00
- Additional Attachments.**
- Box for Handcart, 24 in. wide, 38 in. long, 10 in. deep .... 7.00
- Leaf Rack for Truck ..... 10.00
- Extra Barrels with Trunnions..... 8.00
- Truck and Box Cart ..... 25.00
- Extra Trunnions for Barrel, per pair ..... .50
- Stay Rods for Barrel ..... 1.00

**METAL GARDEN CART.** Made of sheet metal, painted green. Body 14x16 in. Rubber tired 6 in. wheels. Very handy around the garden. Each \$3.00.



**CELERY BLEACHERS.** The home grower and private gardener will find this an ideal system of bleaching Celery—handy, neat and just the thing to bleach a few stalks every few days as wanted. Size 7x14. Doz. 50c, 100 for \$3.00, 1000 for \$25.00.

**CELERY HANDLER** for above. Metal. Each \$1.00. Brass \$3.00.

**CEL-O-GLASS.** A high-grade substitute for glass. Adapted for cold frames, hotbed, sash, etc. Made with wire mesh cloth, transparent and indestructible. In rolls 36 in. wide and any length desired. Per sq. ft. 20c. In rolls of 300 sq. ft., 15c per ft.

**CORN PLANTERS.** The "Wizard Automatic" is a light, but strong and efficient hand planter. Each \$3.00.

**COTTON BATTING.** Large sheets, 40x40 inches. Doz. sheets \$1.00.

**CORK BARK.** For rustic work. Lb. 40c.

**CULTIVATORS, Adjustable Garden.** (Norcross). The blades are forged out of a solid steel rod. 3-prong, \$1.00; 5-prong, \$1.25.

**Speedy.** A light weight long handle weeder with three or four inch stationary prongs of tempered steel. As a cultivator or weeder it is equally effective. 3 prong. Each 75c. 4 prong. Each \$1.00.

**Planet Jr.** (See Page 86.)

**CURBING, Road and Garden.**

Indispensable for curbing drives, walks, flower beds, etc. Made from heavy steel strip 3/16 in. thick by 3 in. deep and 1/4 in. thick by 5 in. deep, each in lengths of 20 feet. For overlap of joints allow 8 inches. The stakes are 1/4 in. thick by 1 1/2 in. wide at the top, tapering to 1/2 in. wide at the bottom. They are 18 in. long. Seven stakes are furnished with each strip.

Supplied in painted green or galvanized stock.

- 3 x 3/16 in. Painted. Per foot 25c.
  - 5 x 1/4 in. Painted. Per foot 37c.
  - 3 x 3/16 in. Galvanized. Per foot 32c.
  - 5 x 3/16 in. Galvanized. Per foot 45c.
- Write for prices on large quantities.

**CUT WORM BANDS.** Made with cardboard to place around the young plant. 100 30c, 1000 \$2.50.

**DIBBLES.** Iron point, with wood handle, for transplanting. Small, 65c, large 85c.

**DIRT BANDS.**

Plants grown in Dirt Bands are not injured in transplanting, as the root system is not disturbed. The bands being square they do not take up as much room as pots and do not dry out so quickly.

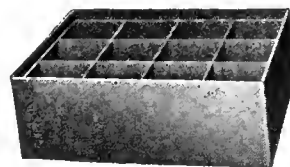

- No. 2, size 2x2, depth 2 1/2 in..... 100 \$0.50 1000 \$4.00
- No. 3, size 3x3, depth 3 in..... .75 6.00

**DIRT BAND PLANT BOX.** Consists of twelve 2-in. Plant Bands and container made with heavy waterproof material. Each 15c, doz. \$1.50.

**DIRT POTS WITH GARDEN FLAT.** The paper pots are square and the flat made with choice lumber.

- Each 6
- No. 1 Garden Flat with 36 2-inch pots ..... \$0.75 \$4.00
- No. 3 Garden Flat with 16 3-inch pots ..... .75 4.00

**DOG SCAT.** A tube containing a chemical which when opened emits a gaseous odor which is slowly released. Dogs hate it and will not come near it. Simply hang the tube on the shrub. Per tube 30c.

**BELLOWS, Powder.**

- Small, Single Cone. Each \$3.00.
- Large, Single Cone. Each \$5.00.
- Double Cone. Each \$6.50.

**DUSTERS, Powder. Brawn's Crystal.**



This duster may be used for dusting orchards, garden truck, flowers, poultry houses or Cyanogas. Glass jar one quart, continuous discharge, fan shaped spreader. Each \$1.25.

**Cyanogas Duster**

The No. 1 Special Cyanogas Duster is made specially for using Cyanogas to exterminate rats, moles and other vermin. It has a 10 in. by 2 1/2 in. barrel and an 11 in. rubber extension. Each \$1.00

**Double Barrel Dust Gun.**

Will dust all kinds of insecticides; has large dust chamber which is easily filled. Length, 13 1/2 inches. Each 75c.

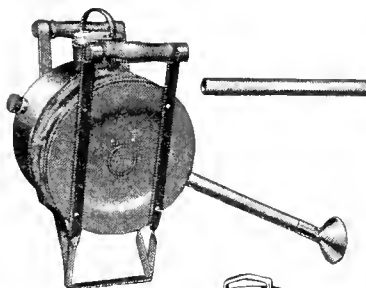

**Platze Green Hand Duster**

A light, compact, sturdy and efficient duster. Capacity 2 to 4 lbs., 30 inch extension. Large powerful bellows. 30-in. extension with spreader. Excellent for dusting either hill crops or under side of foliage. Each \$7.00.

**Dust King Hand Duster**

A powerful and smooth operating one man duster. Can be used for one or two rows. Capacity 5 lbs. Each \$10.75.

**The Savage Duster**

This duster is made with the finest material and will stand long, hard service. Capacity 7 to 10 lbs. of powder. Adapted for use in dusting all kinds of plants. Easy to carry and operate. Weight, packed, 15 lbs. Complete with Elbow \$20.00.

With 2 Row Attachment \$23.25.

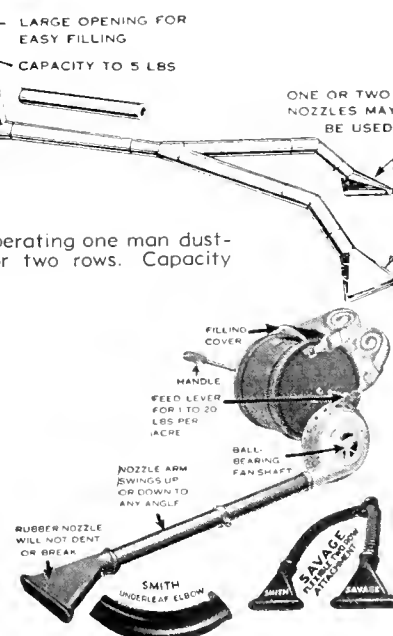

**FERTILIZER SPREADER**



These Spreaders will apply fertilizers, lime, or grass seed economically and effectively.

**Handy Spreader.** 16 in. wide, painted green, easily adjusted for all materials. Will spread Nitrophoska, Lawn Grass, Lime or Fertilizer. Very handy and indispensable for small lawns or gardens. Each \$3.25.

	Width	Capacity	Each
<b>Junior</b>	14 in.	20 lbs.	\$ 5.95
<b>Standard</b>	2 ft.	65 lbs.	10.45
<b>Special</b>	3 ft.	100 lbs.	17.25

**FLATS, Greenhouse.** Made with wood. 3 3/8 in. deep, 12 in. wide, 20 in. long. Doz. \$3.50, 100 \$25.00.

**FLORISTS GUM.** An English liquid gum used for cut flowers. Bottle 30c.

**FLOWER POT STANDS, Walspeer.** A durable stand for large pots or tubs with 4 casters and drip pan. Size 10x12 in. Each \$1.50.

**FLOWER POTS, Earthenware.**  
We pack carefully but are not responsible for breakage in transit. Inside measurements.

Size	Each	Doz.	100	Size	Each	Doz.	100
2 in.	\$0.02	\$0.20	\$1.30	6 in.	\$0.12	\$1.25	\$10.00
2 1/4 in.	.02	.25	1.60	7 in.	.25	2.50	16.00
2 1/2 in.	.03	.30	2.00	8 in.	.35	3.50	24.00
3 in.	.04	.40	2.50	9 in.	.50	5.00	40.00
4 in.	.06	.60	4.00	10 in.	.80	7.00	50.00
5 in.	.08	.80	6.50	12 in.	1.20	13.00	100.00

**AZALEA POTS, Earthenware.**

Wide	Deep	Each	Doz.	100
6 in.	4 1/2 in.	\$.015	\$1.30	\$10.00
7 in.	5 in.	.25	2.50	15.00
8 in.	6 in.	.30	3.00	22.00
9 in.	7 in.	.50	5.00	40.00
10 in.	8 in.	.70	7.00	50.00

**ROUND BULB or LILY PANS.**

Wide	Deep	Each	Doz.	100
6 in.	3 3/4 in.	\$0.15	\$1.50	\$10.00
7 in.	4 1/8 in.	.25	2.50	15.00
8 in.	4 in.	.30	3.00	22.00
9 in.	4 1/4 in.	.50	5.00	40.00
10 in.	4 1/2 in.	.60	6.00	45.00
12 in.	4 3/4 in.	1.00	10.00	80.00

**FLOWER POTS, "NEPONSET." Growing.**  
Made of waterproof paper and are light, clean and unbreakable.



	Doz.	100	1000
2 1/4 in.	\$0.10	\$0.80	\$ 7.00
2 1/2 in.	.10	.90	8.00
3 in.	.15	1.00	9.00
3 1/2 in.	.20	1.30	12.00
4 in.	.25	1.60	14.00
5 in.	.40	2.20	20.00
6 in.	.60	3.00	26.00

**FLOWER POT SAUCERS, Earthenware.**

Size	Each	Doz.	Size	Each	Doz.
4 in.	\$0.04	\$0.40	8 in.	\$0.12	\$1.10
5 in.	.05	.50	9 in.	.14	1.40
6 in.	.06	.70	10 in.	.17	1.70
7 in.	.10	.90	12 in.	.28	2.70

**FLOWER POT SAUCERS, Fibre.**  
Fine quality; mahogany finish.

Size Outside	Each	Doz.	Size Outside	Each	Doz.
6 in.	\$0.65	\$6.00	11 3/4 in.	\$1.10	\$12.00
7 in.	.65	7.20	14 in.	1.50	16.80
8 1/2 in.	.70	7.80	16 in.	1.85	21.00
10 in.	.85	8.85	17 1/2 in.	2.10	24.00

**FLOWER GUARD.**  
Pickets No. 9 wire, spaced 2 7/8 inches apart. Made with steel wire and galvanized after weaving. Each scroll is welded.

16 inches wide, per linear foot	\$0.10
22 inches wide, per linear foot	.12
16 inches wide, per roll 100 feet long	8.00
22 inches, per roll 100 feet long	10.00

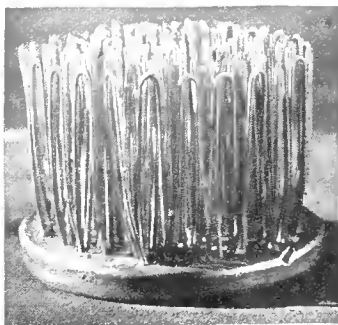

**FLOWER HOLDER**

Made with a lead base. This is the only flower holder that will not tip over. Adapted for shallow bowls and low center pieces for table decorations.  
With 2 in. base. Each \$1.00.  
With 2 3/4 in. base. Each \$2.00.  
With 3 1/2 in. base. Each \$3.00.

**FLOWER CUTTER, Bate's.** The razor blade cutter can be changed. Makes a clean cut. Each \$1.00.

**FLOWER VASES, Fiber and Metal.** (See page 91).

**FORKS.**

	Each
<b>Digging or Spading.</b>	
4-tine, long or short handle	\$2.00
English, 4 square tine, short handle	3.50
<b>Manure.</b> 4-tine, short handle	2.50
5-tine, short handle	3.00
4-tine, long handle	2.50
<b>Transplanting, Johnson's.</b> 3-tine, length over-all 11 in. Each 50c.	
<b>Transplanting.</b> English make. A very superior high-grade tool.	
Short handle	\$0.85
Long handle	\$1.00

**FRUIT PICKERS.** Galvanized wire. "Perfect." Each 60c.

**Bamboo Extension Poles** for above, 12 ft., in three sections. Each \$1.00.

**FUMIGATOR, SULPHUR, Campbell's Patent.** Designed to vaporize sulphur in greenhouses without danger of the sulphur taking fire or disfiguring the foliage.

No. 1, for houses up to 5,000 cu. ft. Each \$ 7.50  
No. 2, for houses up to 10,000 cu. ft. Each 10.50

**FUMIGATOR, X. L.** Lamp and stand, \$2.00. Glass lamps, separate, each 60c. Extra wicks, each 10c.

**GARDEN LINES.** Finest braided hemp. 100 ft. \$2.50, 200 ft. \$4.50.

**GARDEN PENCILS.** Indelible black. Each 15c.

**GARDEN REELS** for Garden Lines, wrought iron. Small \$1.75; large \$3.00.

**GLASS**

**CUTTERS.**



"Red Devil". No. 023, 25c.

**Diamond.** High quality finish. Each \$7.50.

**GLASS FOR GLAZING SASH.** Box of 50 sq. ft. Market price.

**GLAZING POINTS, "Peerless."** 1000 80c.

**GLAZING POINT PLIERS** for the above. Each 90c.

**GLAZING POINTS, Zinc.** 5/8 in. or 3/4 in. Box 60c.

**GLOVES, GARDENER'S.**

**Easy Weor.** A soft, pliable, all leather glove. Useful for garden work. Dirt-proof and durable. Two sizes. Pair 75c.



**Horsehide.** Best quality. Pair \$1.50.

**Ladies' Horsehide.** Size 7 and 7 1/2. Pair \$1.25.

**GRAFTING WAX.** For grafting cuts and bruises on trees. 1/4 lb. 20c, 1/2 lb. 30c, 1 lb. 50c.

**GRAPE BAGS, Paper.** Made with patent metal clasp. 100 75c, 1000 \$6.00.

**GRASS EDGING KNIVES.** See Knives (Page 84).

**GRASS HOOKS or SICKLES.**

Best English welded back.  
No. 2 medium. Each \$1.00. No. 3 large. Each \$1.10.  
American, large size each 35c.

**GRASS SHEARS.** See Shears.

**HAMMERS, GARDEN.** With claw. Each \$1.50.

**HARROW, Smoothing and Leveling.** For leveling land, roads or gardens.

No. 6. One horse. 6 feet wide. Weight 140 lbs. \$30.00

No. 8. Two horse. 8 feet wide. Weight 175 lbs. 35.00

**HEDGE TRIMMER, Simplicity No. 101.**

Actually doing more work with less work. Accomplishing in an hour what formerly took four hours with the old style shears.

Simplicities cut both in opening and closing.

Simplicity Pruner and Trimmer for pruning back old growth of hedge and shrubbery and trimming new growth as well, weighs 3 lbs.

Pruner and Trimmer No. 101 \$5.00.



**HEDGE TRIMMERS—Continued.**



**Little Wonder**

Made with 25, 40 and 60 inch blades. The "Little Wonder" Hedge Trimmer cuts every variety of hedge grown 5 to 10 times faster than the old-fashioned hand shear method. Makes hedge cutting a pleasure. They have long cutting bars which make a quick and even cut. Made strong and sturdy—built to last many years.

- Hand Operated, 30 inch cutting knife .....\$25.00
- Hand Operated, 40 inch cutting knife ..... 27.50
- Hand Operated, 60 inch cutting knife ..... 35.00

**LITTLE WONDER ELECTRIC.**



Electric driven

- Junior Electric, 27-inch cutting knife .....\$ 55.00
- Senior Electric, 36-inch cutting knife ..... 95.00
- Senior Electric, 60-inch cutting knife ..... 100.00

**ELECTRIL HEDGSHEAR.**

The cutters are attached to an endless chain with a 14-inch cutter blade. Motor 1/4 horse power for A. C. or D. C. current. 15 feet covered wire. Each \$29.50. Extra 100 ft. lengths of wire \$4.00.

**HOES, Draw.** With handles. 5 in. \$1.00, 6 in. \$1.10, 7 in. \$1.20, 8 in. \$1.30.

**HOES, Scuffle or Dutch.** English make. Handles 40c extra.

- |                  |                  |
|------------------|------------------|
| 4 in. ....\$1.00 | 8 in. ....\$1.40 |
| 5 in. .... 1.10  | 9 in. .... 1.50  |
| 6 in. .... 1.20  | 10 in. .... 1.60 |
| 7 in. .... 1.30  | 12 in. .... 1.75 |



**HOES, American Scuffle.** 7 in. with handles, \$1.35.

**HOES, WARREN.** Heart-shaped, 7 1/2 in., \$2.00.

**HORSE BOOTS, Leather.** For lawns, made of heavy leather. Medium size, set of four, \$18.00; large size, \$20.00.

**Baker's Metal.** It is made of a steel plate turned up at the toe to protect the turf, with two riveted prongs that fit the horse-shoe in front and a clamp that sets up to the heel. In ordering please send size of horseshoe from toe to heel, or a tracing of the shoe to insure a good fit. Per set, \$10.00.

**HOSE BANDS.** Made of brass wire. For putting on couplings. Doz. 35c. Pliers 50c.

**HOSE CLAMPS. Bolt Pattern.** Doz. 60c.

**HOSE COUPLINGS.** Brass for 1/2 in. or 3/4 in. hose. Each 20c.

- Clincher Style.** 1/2 in. or 3/4 in. Each 25c.
- Rain King.** Quickly snaps on without turning. Each 60c.
- The Jiffey.** Each 60c, doz. \$6.00. Wrench 65c.
- Evertight.** Couples hose with a lever. Each 50c.

**HOSE CONNECTION.** Gooseneck for connecting hose to faucet. Each \$1.00.

**HOSE CONNECTION. Siamese.** For connecting two leads of hose. Each \$1.25.

**HOSE MENDERS.**

Each Doz.

"The Perfect Clinching" 1/2 or 3/4 in. ....\$0.15 \$1.50

**HOSE NOZZLES.**

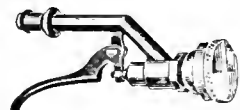

**"Aquamatic."** For sprinkling gardens, washing automobiles, etc. Wastes no water. Spray or stream. Each \$1.75. Nozzles only, each 40c.

**Fan Shower.** Throws a large, soft fan-shaped shower. Can also be used on the Aquamatic Nozzle. Each 65c.



**Aquamatic Control and Shower Nozzle.** Complete \$2.00.

**HOSE NOZZLES—Continued**

**"Gem," or "Grduating."** 3/4 in. hose. Can be regulated to give three different streams. Each 50c.

**Hose Rose.** Made with brass for 3/4 in. hose. 3-in. face 75c. 4-in face \$1.00.

**Magic Spray Pipe.** A spray, stream or shutoff combined. All brass. Each \$1.00.



**Stott's.** A favorite among Rose growers. Single spray, each \$1.75, double spray \$3 00.



**"Water Gun."** A combined hose nozzle and lawn sprinkler. makes a solid stream or spray. Each \$1.50.

**HOSE, RUBBER.**

**Marshall's.** An extra heavy double braided smooth hose for garden use. 1/2 in. per foot, 18c. 3/4 in. per foot, 20c.

**Electric.** A high grade ribbed hose for garden or greenhouse work. 1/2 in. per foot, 20c. 3/4 in. per foot, 22c.

**Special Spray Pump Hose.** 1/2 in. ....\$0.30

**HOSE NOZZLES FOR SPRAY PUMPS.**

**"Bordeaux,"** Adjustable. Each \$1.25.

**Golden Spray.** Fine or coarse discs. Each 70c.

**Shower** for spray pumps. Each 75c.

**"Vermorel."** A fine spray. Each \$1.15.

**HOSE REELS.** Made with tubular iron; strong and durable.

**No. 10.** For 100 ft. 3/4 in. hose. Each \$6.00.

**No. 20.** For 150 ft. 3/4 in. hose. Each \$6.75.

**No. 31.** For 500 ft. 3/4 in. hose. Each \$20.00.

**HOSE WASHERS.** 3/4 in. Doz. 10c, 100 50c.

**HOTBED HEATERS. Everhot Electric.**

The outfit consists of 20 feet of lead covered resistance wire, connected with a waterproof and rust-resisting terminal box. A rubber covered heater cord with connector leads out of the box and is for connection with the lighting circuit.

Model 610—120 watts for 3 x 6 or smaller bed, \$4.00.

Model 615—240 watts for 6 x 6 bed, \$6.00.

**HOTBED SASH, Extra Strong.**

**Unglazed.** Made of best cypress. Regular size 3x6 ft. for using 6x8 in. glass. No. 4, each \$2.50.

**Glazed.** (Packing extra). Size 3x6 ft., using 6x8 in. glass. Painted two coats white. No. 4, each \$5.50.

**Glazed.** Size 3 ft. 2 in. x 6 ft., using 8 x 10 in. glass. No. 9, each \$6.00

**Glazed** with 10x12 in. double thick glass. Size 3x6 ft. Iron cross bar. No. 11, each \$6.00.

**Hotbed Frames for Sash.** Painted. For 2 sash, each \$12.00, for 3 sash each \$16.00, for 4 sash each \$20.00, for 5 sash each \$24.00.

**HOTKAPS.** A wax paper cone that completely covers each plant. An "individual hothouse" for each plant. Hotkaps are quickly and easily set with the setter and tamper supplied with all orders.

- 100 Hotkaps with Setter and Tamper .....\$ 2.40
- 250 Hotkaps with Setter and Tamper ..... 3.65
- 1000 Hotkaps with Setter and Tamper ..... 10.00

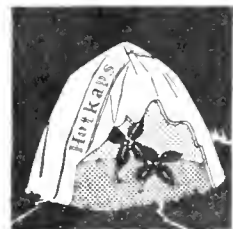

**HYACINTH GLASSES.** Used for bulbs. Each 35c, doz. \$4.00.

**HYACINTH STAKES.** Dyed green. 18 in. long, 100 40c, 1000 \$3.50. Split Bamboo. Green, 18 in., 100 25c, 1000 \$2.00.

**INK.** Indelible for Zinc Labels. Bottle 30c.

**KEEP OFF THE GRASS.** Enameled metal sign. Each 50c.

**KNEE PADS.** Made with rubber. Pair \$2.00.

**KNEELING PADS.** Made with sponge rubber. Size 15 x 7 in. Each 50c.

**KNIVES, ASPARAGUS, American.** Each 50c.

**KNIVES, EDGING.**

**English.** Best steel, handles 50c extra; 9 in. \$2.75.  
**American.** With handles. Each \$1.50.



**KNIVES, BUDDING.**

**American.** No. 40064. Two blades, brass lined .....\$2.00  
**American.** No. L161. Two blades, one round, one sharp point, brass lined \$1.50.



**English, I. X. L.** No. 7955. One blade, black handle .....\$2.50  
**English, I. X. L.** 7956B. Ivory handle, brass lined, sharp point 5.00  
**English I. X. L.** 7956BS. Ivory handle, brass lined, round point ..... 5.00  
**English, I. X. L.** 7954. Two blades ..... 4.00  
**German, Henckel's.** No. 727W. Two blades ..... 2.00

**KNIVES, PRUNING.**

**American.** No. 1391. Small size ..... 1.50  
**American.** No. 1003. Medium size ..... 1.50  
**American.** No. 2149. Two blades ..... 1.50

**English.** No. 7962B.D. Stag handle, small size, one blade. Each \$3.00.



**English, I. X. L.** No. 7689. Stag handle, one blade..... 2.50  
**German, Henckel's.** No. 769. Stag handle ..... 2.00

**LABELS, POT and GARDEN, Wooden.**

Painted	100	1000	Painted	100	1000
4 x 5/8 in. ....	\$0.30	\$2.25	6 x 5/8 in. ....	\$0.50	\$3.00
4 1/2 x 5/8 in. ....	.35	2.50	8 x 7/8 in. ....	1.00	8.00
5 x 5/8 in. ....	.40	2.75	10 x 7/8 in. ....	1.25	10.00
			12 x 1 1/8 in. ....	1.50	13.00

**Wood, Copper Wired.** 3 1/2 in. Painted. 100 50c, 1000 \$3.00.

**Clear View.** Iron stake 26 inches long with card holder 3 1/2 x 3/4 in. Very durable and easily read. Doz. \$2.00, 100 \$15.00.

**Celex.** No. 15. Hanging, wired. Size 3 x 1/2 in. Made with white celluloid. Doz. 25c.

**Celluloid Hanging.** With copper wires, 3 1/2 in. long by 1 1/16 in. wide. Doz. 25c, 100 \$1.25. 3 1/2 in. long, 1 1/2 in. wide. Doz. 75c, 100 \$5.00.

**Celluloid Pot.** No. 22. 5 in. long, 3/4 in wide. Doz. 50c, 100 \$3.00; No. 23, 6 in. long by 1 in. wide, doz. 60c, 100 \$4.50.

**"Indestructo."** A superior, everlasting label made of copper metal. The name desired is permanently written with a metal stylus supplied in each box.



No. 1 3/4 x 3 3/4 in. 100 \$2.00. No. 2 1 1/8 x 5 in. 100 \$2.50.

**Magno Garden.**

This label derives its name from the fact that its glass top enlarges the lettering on the card name, making it easy to read at a distance. It is 1 23/8 inches long, rustproof, waterproof, sturdy and durable. Doz. \$2.50, 100 \$18.00.

**The Marshall Plant Label.** A perfect waterproof label for tying to plants or stakes. Doz. 50c, 100 \$5.00. Samples sent on request.

**Perfect Garden Label.** Made with indestructible material. Gray-green, Duco-like surface. Use ordinary lead pencil which will last for 3 to 4 years. **Border size.** 2 by 1 1/4 in. marking space. 3 1/4 in shaft. Doz. \$1.00, 100 \$7.75. **Rock Garden size.** Shaft 2 3/4 in. Doz. 90c, 100 \$6.75.



**Simplex Green Waterproof.** No. 51. Pots or rockeries. Size 4 x 5/8 in. Doz. 60c, 100 \$3.00.

**LABELS—Continued**



**Simplex Green Waterproof.** No. 31. Hanging, size 3 x 1/2 in. Doz. 50c, 100 \$2.50.

**LABELS, The Simplex Waterproof.**

	Doz.	100
No. 1. 3 x 1/2 in. ....	\$0.55	\$3.00
No. 2. 4 x 3/4 in. ....	.75	5.00
No. 3. 5 x 1 in. ....	1.00	7.00

**Simplex Garden.** No. 10 with iron stake 24 in. long and metal ticket holder, Doz. \$3.00, 100 \$25.00. Extra Cards, 100 \$3.00.

**Simplex Weatherproof Ink.** For Celluloid Labels. 1/2-oz. bottle \$1.00.

**Tree or Garden, Zinc.** Per 100:

No. 1.....\$3.00	No. 5.....\$3.50	No. 13.....\$1.50
No. 2..... 3.00	No. 6..... 1.50	No. 15..... 2.00
No. 4..... 3.00	No. 7..... 1.50	No. 21..... 2.00

Ask for shapes and sizes.

**INDELIBLE INK.** For above. Bottle 30c.

**LAWN CLEANERS, Pennsylvania**

This machine will remove from the lawn not only the cut grass but all sorts of litter, leaves, etc. The suction created by the three rapidly revolving rakes or brushes cleans the lawn similar to a vacuum cleaner. The brushes are used for removing worm-casts from putting greens, etc. Provision is made for adjustment to take up wear of the brushes. The change from rakes to brushes is easily made without taking the machine apart. Width 24 inches only. \$35.00. Extra set of brushes or rakes, \$8.00.  
 Always designate Rakes or Brushes when ordering.

**LAWN EDGERS, Planet Jr. No. 2.**



The cutting blade is made of the best quality steel and well sharpened. The handle is strong, being made of good quality wood. In order to have attractive lawns, keep the edges well trimmed. Price \$1.50.

**LAWN MOWER SHARPENER. "Carborundum."** A simple, efficient device that will sharpen any Mower in a few minutes. Each 50c.

**LAWN MOWER SHARPENING COMPOUND.** Per can, 60c.

**LAWN MOWER SHARPENER, "Bergman."**

An individual sharpener which is adjustable to all types and makes of lawn mowers. No danger of making low spots in the blades as with a file, as a long, sweeping stroke with a Bergman grinds the blade evenly. Each \$1.00. Postage 10c extra.



**LAWN RAKES.** (See Rakes).

**LAWN ROLLERS.**

**Lanco Water Ballast Roller.** Can be filled with water or sand. Edge of drum rounded to prevent tearing of sod. Drum roller is made of 12 gauge steel and drum end with 10 gauge, electrically flow welded. Axle fitted with roller bearing.

Diom	Length	Weight Empty	Weight Filled	Each
14 in.	24 in.	80 lbs.	187 lbs.	\$13.00
18 in.	24 in.	92 lbs.	290 lbs.	15.00
24 in.	24 in.	107 lbs.	430 lbs.	16.50
24 in.	32 in.	142 lbs.	577 lbs.	18.50

**LAWN SPRINKLERS.** (See Page 90).

**LAWN TRIMMER and EDGER.**

Does what lawn mowers leave undone. It can be run close to wall and trees, cutting grass clean and quickly. Can also be used for trimming edges of walks, etc. It has four blades, 8 inches wide. Each \$10.00.

All prices are subject to change.



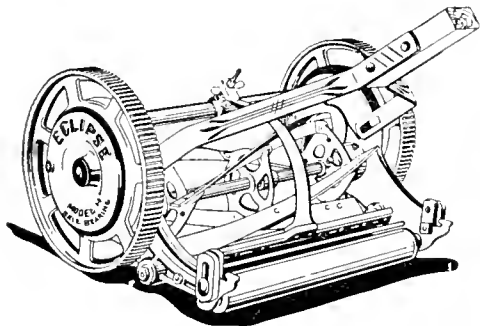

Eclipse Model M

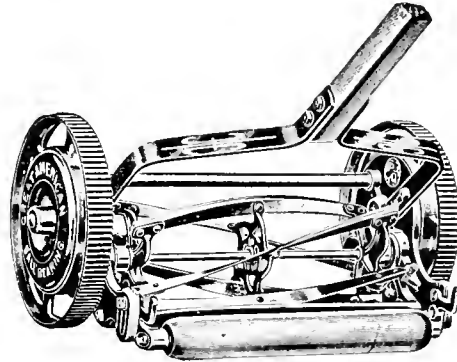

Great American Mower

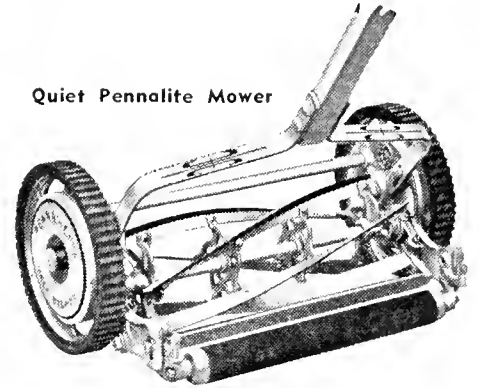

Quiet Pennalite Mower

**LAWN MOWERS**

**Eclipse Model M Lawn Mower**

The Eclipse Mower is automatic self-sharpening with a finger tip adjustment on the cross bar. They have patented ball bearings, 10-inch wheels and four blades.

14-inch.....\$13.50      16-inch.....\$14.50

**Eclipse Model L Lawn Mower**

This machine is similar to the Model M, but has five blades on the revolving cutter.

14-inch.....\$15.75      16-inch.....\$16.50

(With pneumatic rubber tires, \$2.00 extra.)

**Great American**

A double geared mower which gives fine results.

10½-inch high wheel, 5-blade cylinder, ball bearing.

15-inch.....\$17.00      19-inch.....\$21.00

17-inch..... 18.00      21-inch..... 22.00

**Pennsylvania Junior**

The Pennsylvania Junior High Wheel is the pioneer of all lawn mowers, having an open cylinder, open wheels and a train of gears. High wheel. 10½-inch diameter. Five blade cylinder.

15-inch.....\$20.00      17-inch.....\$22.00      19-inch.....\$24.00

**Quiet Pennalite Mower**

Aluminum, Rubber Tires, and Covered Roller.

The lightest mower made. Weight only 29 lbs. Geared on each 10-inch wheel. Six-inch five-blade cylinder.

15-inch.....\$19.00      17-inch.....\$20.00

**Townsend's Flyer**

A good, free cutting, easy running lawn mower with open wheel and frame, made on the two-gear principle. Gears well up from the ground and fully shielded so as to exclude dirt and cut grass. Has 9-inch wheels, four bladed reel.

14-inch.....\$10.25      16-inch.....\$11.00

**Townsend's Kutall, X**

Cuts all plantain, dandelion and weeds in the path of the mower. It has a hook-like blade between each cutting blade which draws the weeds into the cutting unit. 10-inch wheels, four blades.

14-inch.....\$13.00      16-inch.....\$14.00      18-inch.....\$15.00

**Townsend's Victory**

This mower is fitted with **Ball Bearings**. Gear entirely closed, so no dirt or cut grass can find its way into the pinions and clog them. Cutter bar easily removed for sharpening without disturbing frame. The knives cut the instant the mower is moved.

14-inch.....\$15.00      18-inch.....\$17.00

16-inch..... 16.00      20-inch..... 18.00

**"Easy" Border Lawn Mower**

The only mower made that will cut borders, mounds, terraces, close to walls and fences, and all kinds of uneven surfaces with the same ease and efficiency as the smoothest lawn.

It has a steel open roller, four spiral blades, self-adjusting ball bearings with detachable handle. Net prices:

12-inch, \$23.00; 14-inch, \$26.00; 16-inch, \$29.00.

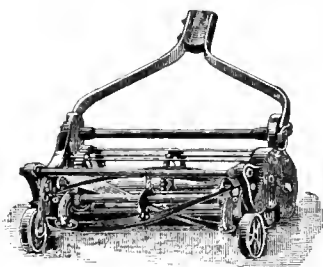

"Easy" Lawn Mower

**LAWN MOWER GRASS CATCHERS**

Galvanized sheet metal bottom with heavy duck canvas sides. Hooks to frame of Mower and handle. Easily detached for emptying. Net Prices:

12-inch, 14-inch or 16-inch...\$2.00      18-inch or 20-inch...\$2.25

**LAWN MOWERS, MOTOR**

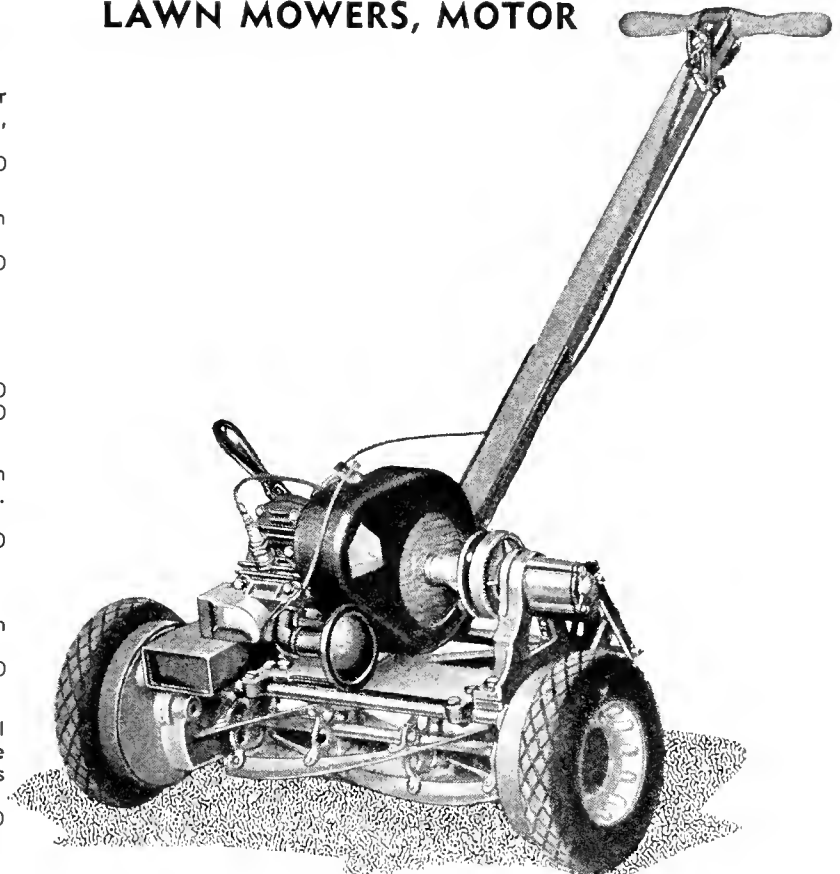

Stearns Power Mower, No. 118

**Stearns Power Mowers**

**Stearns Power Mower No. 118.** Specifications: Drive wheels 10-inch diameter, 1¾ in. tread. Engine, single cylinder, 4 cycle, rated at 5/8 horsepower. Five blade cutting reel, width 18 inches. Weight 115 pounds. Price: \$76.00. With Rubber tired wheels \$83.50 F. O. B. New York.

**Stearns Power Mower No. 18.** Specifications: Drive wheels, open type, 11-inch diameter, 17/8-inch tread. Cylinder 5 self-sharpening blades, 6-inch diameter. Bearings, Hyatt roller in wheels and rear roller. Norma-Hoffman ball bearings in cylinder, clutch and drive shaft. Engine, Briggs & Stratton Model H, four-cycle, rated at one-half horsepower. Width of cut 18 inches. Net weight, 150 pounds. Price \$101.50 F. O. B. N. Y.

**Stearns Power Mower No. 21.** Specifications similar to the No. 18, except wheels are 2¼-inch tread. Width of cut 21 inches. Weight, 160 pounds. Price, \$119.50 F. O. B. N. Y.

**Stearns Power Mower No. 24.** Specifications similar to No. 18, except wheels are 3-inch tread. Engine, one horsepower. Width of cut, 24 inches. Weight, 240 pounds. Price, \$198.00. F. O. B. N. Y.

**Stearns Power Mower No. 27.** Specifications similar to the No. 24, excepting width of cut is 27 inches and weight 250 pounds. Price, \$238.00 F. O. B. N. Y.

Prices for 1937 were not available when we issued this list. Any slight changes will be given on request; also fully illustrated 1937 Catalogue.

Prices on all Lawn Mowers are subject to change.

- LEAF-MOULD.** 1-barrel bag, \$3.50.
- LIGHTNING WIRE TIE CLIP.** For fastening plants to wooden stakes 100 35c, 1000 \$2.50.
- LINE WHITE.** The best preparation for marking Tennis Courts. 50 lbs. \$4.50, 175 lbs. \$12.00.
- LINES.** (See Garden Lines).
- MARBLE DUST.** Used for marking Tennis Courts with a dry marker. 50 lbs. \$2.75, 100 lbs. \$5.00.
- MATTOCKS. "Oak Leaf."** Hoe, 4 1/4 in. Cutter, 3 in. Each \$1.50. Handles 50c.
- MATS, FROST-PROOF, Hotbed.** These mats are 76x76 in. square and made of strong burlap filled with cotton. Waterproof one side, burlap on other. 40x76 in. each \$3.00, doz. \$34.00, 76x76 in. each \$4.50 doz. \$52.00.
- MELON FRAMES.** One light of 10x12 glass in cypress frame. Each \$2.25, doz. \$24.00.
- MELON NETS.** English make. Doz. \$2.50.

- MOLE TRAP. Acme.** The most effective trap. Easily set, rust proof, safe and sure. Each \$2.00.
- Schroeter Improved.** Low built and self-setting. Each \$2.25.
- MO-LO.** A preparation for destroying moles. Pkg. 25c.
- MOLOGEN.** Used to drop in the run, non-poisonous. 1/2-lb. can 50c.

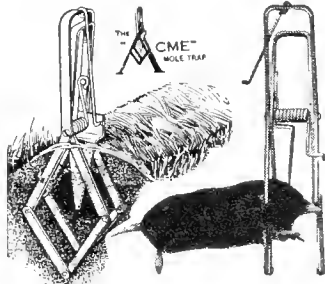

- MOSS, SPHAGNUM.** Live. For orchids. Bag \$2.50. For packing, 5-bbl. bal \$4.00. Green, in sheets. Bag \$4.50. Dyed Green, in sheets. Bag. \$7.00.
- MULCH PAPER. "Gator Hide."** Used for mulching all kinds of flowers, vegetables and fruits.
- Type B. Sample Roll.** Heavy weight. 67 sq. ft. 65c.
- Type B. Heavy weight.** 18 in. wide. 150 yards long. Per roll \$3.00.
- Type B. Heavy weight.** 36 in. wide. 150 yards long. Per roll \$6.00.
- MULTI-MULCH.** A top dressing for lawns and borders. 25 lbs., \$1.00; 50 lbs., \$1.75; 100 lbs., \$3.00.
- NAILS, English Wall.** 1 1/2 in. Chandler's patent with lead tip to turn over vine. About 40 nails to lb. Lb. \$1.00. Cast Iron. 1 1/2 in. About 140 nails to pound. Lb. 25c.
- NETTING, Bird.** for Strawberry beds, etc.; 20 or 30 ft. wide. Per lb. \$3.00; 1 lb. will cover 200 sq. ft.
- NOMOLE.** A chemically treated mole food which wipes the pests out in 2 days. Large 28-oz. can \$2.00.
- NOZZLES.** (See Hose Nozzles.)
- OIL CANS.** For lawn mowers, etc., brass bottom. 30c.

- PAPER.**
- Crepe.** Green. Per roll 50c.
- Kraft.** Sheets 40x48 in. or 30x40 in. Per lb. 12c.
- Kraft.** Rolls 18 in. or 24 in. wide. Per lb. 12c.
- Tissue.** Ream (480 sheets). 24x36 in., \$1.75.
- Waxed Tissue.** Ream (480 sheets). 24x36 in., \$2.50.
- Waxed Tissue. Green.** Ream (480 sheets). \$3.00.
- PEAT MOSS.** Granulated Peat Mass should be used liberally about the garden, for mulching perennial beds, lawns, Roses, etc., and mixing with sandy or clayey soils.
- Small bale,** enough to cover 16 sq. ft., 1 in. deep. Weight 15 lbs. Postage extra. \$1.50
- Large bale,** 13 cu. ft., covers 240 sq. ft., 1 in. deep. 3.50
- Sorbex Peat Moss.** A fine ground grade. Per sack \$2.50.

- PEAT, Rotted.** 1-bbl. bag, \$2.25.
- PEAT, Orchid.** 1-bbl. bag, \$2.75. Bale of 10 bushels, hand picked, \$10.00.
- PENCILS, GARDEN.** For labels. Each, 15c.
- PICK MATTOCKS, "Oak Leaf."**
- Hoe 4 1/4 in.  
Pick 8 1/2 in.  
Each \$1.50.  
Handles 50c.



- PICKS.** Painted both ends. 23 inches. Each \$1.50, handles 50c.
- PLANT GUARDS.** To protect plants against cut-worms, etc. 100, 30c; 1000, \$2.50.

- PLANT SPRINKLERS.**
- Rubber.** Scollay's straight neck. No. 1, 12-oz. size, \$1.50.
- Rubber Plant Spray.** Small size 60c.
- The Ideal.** Made entirely of metal and fits any bottle; can be used at any angle for insecticides or water. Each, \$1.00.

- PLAN-TIE.** See Twines.
- PLANET JR. CULTIVATORS.**
- No. 4 Planet Jr. Combined Hill and Drill Seeder, Single Wheel Hoe, Cultivator and Plow**
- Does the work of almost all garden tools combined. It sows accurately all garden seeds in drills or in hills 4, 6, 8, 12 or 24 inches apart, cultivates, furrows and plows.
- No. 4, complete.....\$17.00  
No. 4D, as a Seeder only..... 13.75

- No. 12 Planet Jr. Double and Single Wheel Hoe Combined**
- It has one pair plows, one pair hoes, two pair cultivator teeth and a pair of leaf lifters.
- No. 12, complete.....\$10.75

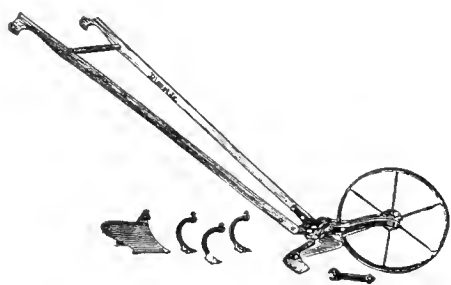

No. 17 Planet Jr. Single Wheel Hoe

The No. 17 has a pair of 6-inch hoes, a plow and a set of cultivator teeth, an outfit sufficient for most garden work. Complete, \$7.50.

**Planet Jr. Jiffy Hoe**

A handy tool for the small garden. It weeds and cultivates. Steel, adjustable handle, with 3 cultivator teeth. Price \$2.00.

**No. 25 Planet Jr. Combined Hill and Drill Seeder. Double and Single Wheel Hoe, Cultivator and Plow**

As a seeder it will sow in drills any thickness or drop in hills 4, 6, 8, 12 or 24 inches apart.  
As a wheel hoe it is practically the same as the admirable Planet Jr. No. 12 Double Wheel Hoe, Cultivator and Plow. No. 25, complete, \$21.50.

**EXTRA PARTS FOR PLANET JR'S.**

Cultivator Teeth. Each 40c. Hoes, 6-inch, per pair \$1.30. Plow for S. W. H., each \$1.35.

**PLANT STAKES.** Wood, painted green. Round, tapering.

	Each	Doz.	100
2 ft. x 3/8 in.....	\$0.05	\$0.50	\$3.00
3 ft. x 1/2 in.....	.07	.70	5.00
4 ft. x 5/8 in.....	.10	1.00	7.00
5 ft. x 5/8 in.....	.20	1.50	10.00
6 ft. x 3/4 in.....	.25	2.25	16.00

**BEAN POLES.** Cedar, painted, 8 ft. to 9 ft. Doz. \$4.50, 100 \$30.00.

**DAHLIA POLES.** Heavy, round green; tops painted white.

	Each	Doz.	100
3 ft. ....	\$0.20	\$1.80	\$11.50
6 ft. ....	.30	3.00	20.00

**DAHLIA STAKES.** Extra heavy. 7/8-in. square at bottom tapering to 3/4-in. at top, painted green.

	Doz.	100
5 ft. ....	\$1.75	\$13.00

**DAHLIA STAKES. California Redwood.** Natural finish.

	Doz.	100
5 ft. long, 1 1/4 in. square.....	\$1.75	\$12.00
6 ft. long, 1 1/4 in. square.....	1.85	14.00

**GALVANIZED WIRE, for Roses, etc.** Plain or Anchored. No 9 wire.

	100	100	100
2 1/2 ft.....	\$2.50	3 1/2 ft.....\$3.50	4 1/2 ft.....\$5.00
3 ft.....	3.00	4 ft..... 4.00	5 ft..... 5.50

**PLANT STAKES—Continued**

**S. L. N. WIRE STAKE.** A new and practical device for supporting flowers. The spiral end forms a circular hook for the flower. 36 in. long, 24 in., 25, \$1.80, 100 \$6.00. 36 in., doz. \$1.00, 25 for \$2.00, 100 \$7.00.



**PLANT SUPPORTS.**

**"ADJUSTO"**

The "Adjusto" is a very simple, unbreakable, practical and cheap support which will last a lifetime. It is adjusted in a "jiffy" to any height, to conform to the plant's growth. It is indispensable for Tomatoes, Roses, Hydrangeas and Dahlias.

The stake is made of hardwood having a protecting coat of green paint; the heavy spring wire is also painted green and so will not rust. Wires 13 inches in diameter.

Stakes 7/8 in. square.

3 ft. height, complete.....\$1.90 per doz.  
 4 ft. height, complete.....\$2.15 per doz.  
 5 ft. height, complete.....\$2.40 per doz.  
 Extra 13 in. wire loops (for use on the taller stakes and plants), \$1.20 per doz.

Each Doz.

2 ft. stake with wire 1/4 in. diameter for pot plants and Carnations. 100, \$9.00.....\$0.12 \$1.00

**PEONY SUPPORT.** No. 3A. 4 ft. stake of No. 4 wire. 5 ft. cord. Doz., \$2.10.

**PLOW, Firefly**

This tool will enable a busy man to do nearly all the work of a family garden. Chicken raisers find it of great advantage in plowing up their scratching yards. Price, \$4.25.

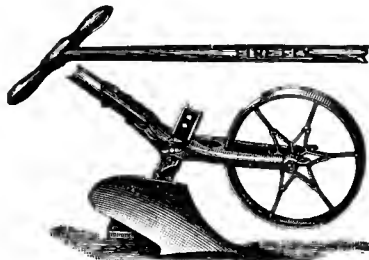

**POST HOLE DIGGER.** The blades are 9 in. long and the handles 5 ft. long. Each \$2.00.

**POT HANGERS.** Made with galvanized wire. 18 in. Each 25c, doz. \$2.00, 100 \$12.00. 24 in. Each 30c, doz. \$2.50, 100 \$18.00.

**POTATO HOOKS.** Broad, round prongs. 4-prong \$1.50, 5-prong, \$1.75.

**POTS.** (See Flower Pots, Page 82).

**POWDER GUNS.** (See Page 81).

**PRUNER, or Lopping Shears.**

**Eagle Lopping Shear.** 20-inch handle. Each \$2.00.  
**Forester No. 2.** With lever cutting power. Length 27 in. Will cut wood 1 1/2 in. diameter. Each \$5.50.

**PRUNERS, TREE.**

**Bartlett No. 1 Jointed Tree Trimmer.** A new and very efficient tree trimmer and pruner. The pole is made in sections of four feet each enabling the user to have a selection of an 8 ft., 12 ft. or 16 ft. pruner. Superior quality throughout. No. 1. 16 ft. jointed pruner. Each \$7.50.

**Little Giant Pruner Hook and Saw Combined.** Attaches to pole of any length. Each \$4.00.

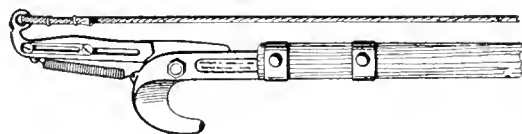

**Hadley Pole Pruner.** The only pruner with two cutting blades. No. 2 with 5 ft. pole and 5 foot extension. Each \$6.00.



**Waters' Patent.** 10-ft. handle, \$2.50. 12-ft. handle, \$2.75. Extra blades, 30c each.

**PUMP. Brass Bucket Spray.**

This Spray Pump is especially designed for spraying in gardens and greenhouses. The pump is double acting. Each \$6.00.

**PUMP. "The Kinney."** For distributing water and liquid manure through the hose at the same time. Each \$2.25.

**PUMPS.** (See Spray Pumps, Pages 88, 89).

**PUTTY BULB, Rubber.** For glazing, \$1.35.

**RAFFIA.** The best material for tying plants. Per lb. 50c. Green, dyed, lb. \$1.25.

**RAFFIA TAPE.** Green, in spools of 100 yards. Each \$1.00.

**RAKES. Bamboo Lawn.**

This rake cannot be compared with the cheaper quality that is often offered. The head is wired top and bottom and has a four-foot wood handle clamped onto the rake. 18-inch, each 60c. Large size, 24-inch, \$1.00.

**Fuller Lawn Broom.** Made with oil tempered spring steel teeth, spaced 3/4 inch apart. Strong and durable. 18 in., \$1.75; 24 in., \$2.00.

**Garden.** Best steel, 8 teeth, \$1.00; 10 teeth, \$1.20; 12 teeth, \$1.30; 14 teeth, \$1.40; 16 teeth, \$1.50; 18 teeth, \$1.60.

**Gem Dandelion.** For eliminating Dandelion and other seeds of weeds in lawns. It has fine bladelike teeth that lie flat against the sod and clip off all buds and flowers. The self-cleaning attachment combs the teeth clean and is connected to a rod on the handle which cleans the teeth on a slight pull on the finger hook, the spring sending the cleaning bar back to its position. Width, 15 inches. Each, \$2.50.

**Hay.** Wooden, 3 bows, 12 teeth, \$1.10.

**Hoover Lawn.** The teeth of this rake are made with flexible steel spring wire, taking all leaves, dead grass or refuse without any injury to the living grass. 20 inches wide. Each, \$1.00.

**Lawn.** Wooden, 3 steel bows, 20 teeth, \$1.40.

**Lawncomb.** Useful for lawns or leaves. Twenty-four flat flexible steel teeth. 24 inch. Each, \$1.75.

**Olsen Lawn.** 26 wooden teeth, iron brace, \$1.15.

**Reversible.** Galvanized, 24 teeth, \$1.25.

**Rake and Hoe.** A combination tool, \$1.10.

**REELS, GARDEN.** For garden line. Each, \$1.75 and \$3.00.

**RIFLES, EMERY.** For sharpening. Each, 15c.

**Carborundum.** No. 57. Will sharpen any garden tool. 9 in. long with wood handle. Each, \$1.00.

**ROLLERS.** (See Page 84).

**RUBBER BANDS.** For split Carnations. Oz., 30c.

**RUBBER COATS.** State size wanted. \$9.00.

**RUBBER BOOTS, Gardeners' and Farmers'.** State size when ordering. Per pair, hip length, \$7.00, knee length, \$5.50.

**SASH, HOTBED.** (See page 83).

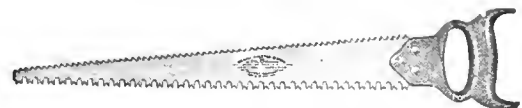

**SAWS.**

**Pruning Disston.** Single edge, 16 in. \$1.50, 18 in. \$1.75, 20 in. \$2.25. Double edge, 16 in. \$1.75, 18 in. \$2.00, 20 in. \$2.75.

**Double Swivel.** Blade 14 in. long. Very useful for pruning. Each \$2.25. Extra blades. 35c.

**Crescent Pattern.** 16 in.. each \$1.50.

**Hand or Pruning.** 20 in. blade, each \$2.25.

**Cross-cut, One Man.** Cuts easily and rapidly. 4 ft. Each \$4.75.

**SAW FILES.** Best make. Each 20c and 25c.

**SCISSORS.**

**Grape or Vine.** Best make, 7 in., 1.50.



**Flower Gatherers.** Best quality, 6 3/4 in., \$1.75.



**Flower Gatherers.** No. 30. 6 inches. Each 50c.

**SCISSORS, PRUNING.** English make, 4 in., \$2.25; 5 in., \$2.50

**SCYTHES.**

**Lawn, English.** 30 to 34 in., each \$3.00.  
**Grass, American.** 30 to 40 in., each \$2.50.  
**Brush or Weed.** 18 to 21 in., each \$2.25.

**SCYTHE SNATHS (or Handle).** Each \$2.25.

**SCYTHE STONES.** Flat, each 25c, doz. \$2.50.

**Carborundum.** No. 57. Each \$1.00.  
**English.** Round pointed. Each 35c.

**SEEDERS.**

**Cahoon's Broadcast Sower.** This machine will sow wheat, rye, oats, barley, hemp, timothy, clover, millet and Hungarian millet, throwing from 8 to 20 feet on each side of the operator. \$6.00.

**Wheelbarrow Double Hopper Seeder.** This seeder will sow grass seeds as well as heavy seeds of all kinds. It can be regulated to sow any quantity per acre the whole length (14 feet) of the hopper and it does not clog up. Full directions with each seeder. No. 9. Price \$21.00.

**SHADING, Summer Cloud.** English shading for greenhouses. 1/2-lb. pkg. 75c, 1 1/2-lb. pkg. \$2.00.

**SHEARS.**

**Grass Border.** English (without wheel).  
 9 in. .... \$6.00  
 10 in. .... 6.50

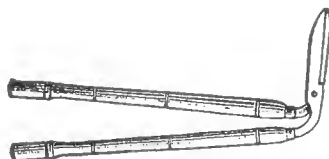

**American.** Without wheel. 9 in., \$4.00.

**Doo-Klip Grass.** Long handle. Each \$2.50.

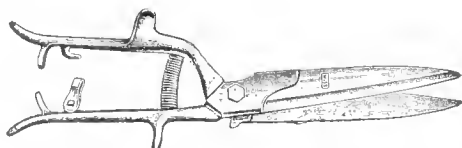

**Grass.** 6 in. steel blades with 7 in. metal handle and spiral steel spring. \$1.10.

**Grass or Sheep.** Best trowel shank. \$1.25.

**Grass.** Wiss-Klip. No. 700. 6-inch blade. \$1.50.

**Hedge, English Make.** 8 in., \$3.00; 9 in., \$3.50; 10 in., \$4.00. With notch, 35c extra.

**Extra Bolts, Nuts and Washers.** Per set 25c.

**Lopping Shears.** (See Pruners).

**SHEARS, PRUNING.**

**California Pattern.** 9 in. long. (See cut). Each \$1.00.



**Clean Cut.** Double cutting blades, compound leverage. Length 10 1/2 inches. \$2.50.

**Disston Pruning No. 117.** 9 in., extra strong. Each \$1.50.

**Henckel's Pruning.** No. 192. Can be used for heavy or light branches. 8 1/2 in. \$4.00.

**Kunde.** Imported. No. 135. 8 in. Each \$6.00.

**Ladies' Pruning.** 6 1/2 in. Nickel plated. \$1.50.

**Perfection Pruning.** Cuts on both sides. 6 1/2 in., \$3.50; 7 1/2 in., \$4.00; 8 1/2 in., \$4.50; 9 1/2 in., \$5.00.



**SHEARS—Continued.**

**Snap-Cut.** Rust-proof chromium finish. Good for small branches. 7 1/2 inches. \$2.00.

**Watch Spring Pruning.** Imported French. 7 in., \$3.00; 8 in., \$3.50; 9 in., \$4.00.



**Wiss, Hand Pruning.** (Solid Steel). 9 in., \$3.50; 10 in., \$4.00; extra blades, \$1.00 each.

**Wiss Pruning No. 309.** Forged steel blades. 9 in., \$2.50.

**SHARPENER, Self Grinding.** For sharpening knives, shears, scissors, etc. Each \$2.00.

**SHREDS, Medicated Garden.** For nailing trees to walls, etc. 3 in., 60c per 100; 4 in., 75c per 100.

**SHOVELS, Square and Diamond Pointed.** Long or short handles. Each \$2.00.

**SIEVES, WIRE.** For sifting loam, gravel, etc. 1/8 in., 1/4 in., 1/2 in., or 3/4 in. mesh, 18 in. in diameter. Each \$3.00.

**SIGN, "Keep Off the Grass."** Metal with enameled letters. Size 3 1/4 x 19 in. Each 50c.

**SILKALINE, Meyer's Green.** Fast color. Spool 50c. Box of 8 spools \$3.50.

**SMILAX TWINE, Green.** Box of 8 balls \$1.25.

**SOIL TESTER, "Soiltex."** The new pocket soil tester, contains enough material for making 75 to 100 soil tests. Outfit complete \$1.00.

**SPADES.** Best cast steel. Long or short handles. Each \$2.00.

**SPRAYERS.**

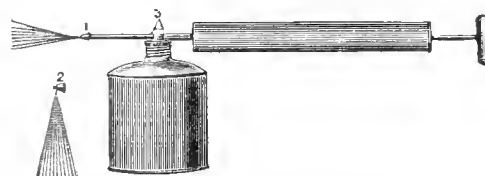

**Compressed Air Sprayer**

These Sprayers give a continuous spray, reduce the liquid to a fine mistlike vapor and throw it with great force, so that it is driven into the smallest cracks and crevices. By means of the universal nozzle the spray can be thrown on the under side of the leaves of plants and shrubs.

**Tin Pump and Galvanized Container.** No. 50G \$1.25.

**Brass Pump and Container.** No. 50B \$1.75.

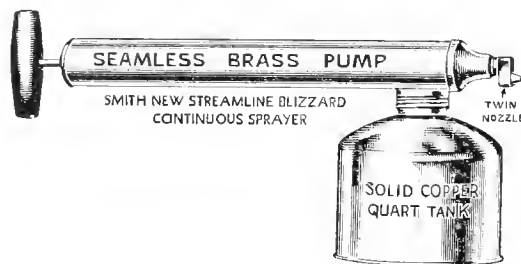

**Blizzard Streamline**

A continuous sprayer with copper tank, seamless brass pump chamber. Straight or angle nozzle. 12-in. extension. Each \$2.00.

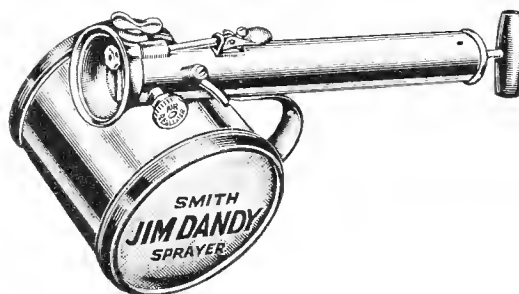

**Jim Dandy Sprayer**

Adapted for spraying vegetables and flowers, small fruits, etc.; also valuable for spraying disinfectants in buildings. Capacity 3 quarts. Each \$3.50.

**Sturdy, No. 45 Spray Pump.**

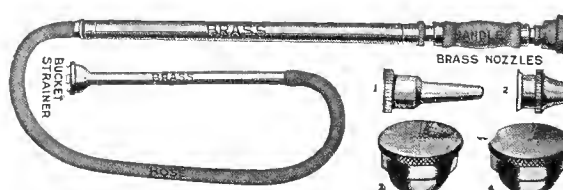

The Sturdy is made with all brass parts, it may be used in pail or can. Four nozzles for all kinds of spraying. Easily operated by one man. Each \$4.25. Extension rods, 24 inches. Each 60c.



Platz Vermors Sprayer



Banner Sprayer



Lightning Sprayer

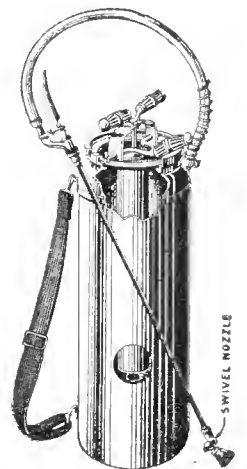

Auto No. 4B

**SPRAYERS—Continued**

**Auto Sprayers.** We recommend them for trees, shrubs, and vines, greenhouses, poultry houses, hospitals and stables for disinfectants, for sheep and cattle dip and fly oils. It may be used where any bucket or knapsack Sprayer can be used, and with much more satisfaction.

- No. 4B. **Open-Hed.** Brass-copper alloy, electrically welded seams. Tank opening 5 inches, rubber grip pump handle. Capacity 4 gallons. . . . . \$8.90
- No. 4D. **Open-Hed.** Heavy galvanized steel. Electrically welded. Capacity 4 gallons. . . . . 5.60
- No. 3B. **Open-Hed.** Brass-copper alloy. Capacity 3 gallons. . . . . 6.95
- No. 3D. **Open-Hed.** Heavy galvanized steel. Capacity 3 gallons. . . . . 4.50

- Auto Sprayer Parts.**
- "Auto-Pop" nozzle with hose and connections. . . . . \$2.00
  - "Auto-Pop" nozzle . . . . . 1.50
  - Extension pipe, brass, 2 ft. lengths, each. . . . . .60
  - Elbow extension, solid brass . . . . . .35
  - Set of soft and brass parts for No. 9. . . . . .50
  - Two row attachment, 1 nozzle. . . . . 1.50

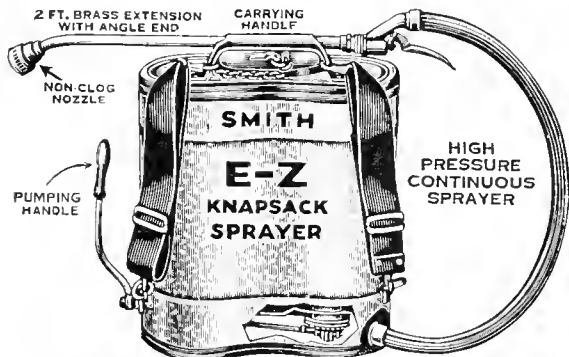

- E. Z. Knapsack Sprayer.** A high pressure continuous sprayer for spraying all truck and garden plants. Capacity 4 gallons. 3 feet of hose and 2 foot brass extension rod. Complete with solid brass tank. No. E. Z. C. . . . . \$18.00
- Complete with galvanized steel tank. No. E. Z. G. . . . . 12.00
- Lightning Sprayer.** A very handy sprayer for small work around the garden. Tank 2 1/2 by 7 1/4 inches. Capacity 3 1/2 gallons with automatic nozzle. Galvanized steel tank. Each \$4.00.

**New Wonder Compressed Air Sprayer.**

A handy, easy to operate, efficient Hand Sprayer. Spray material mixed in special glass container. It has many uses for the home gardener. Excellent for spraying plants, poultry houses or aviaries. Each \$2.50. Extension rod 60c.



**Paragon No. 3 Sprayer.** Mounted on a strong metal truck and can easily be wheeled to any desired place.

Equipment: 10 ft. Special Spray Hose, 7 1/2 ft. Extension Pipe, one Mist Nozzle, one Steel Cap, one Straight Spray. Any additional length of hose can be furnished at a reasonable extra charge. Capacity, 12 gallons, galvanized tank. Price, \$22.50. Without truck, \$21.50.



Paragon Sprayer No. 3

**Banner Sprayer.** Open top compressed air sprayer. Solid copper tank. 4-gallon capacity. 28 in. hose, 2-ft. brass extension rod. No. 22 CO. Each \$9.00.

**Platz Vermors Brass Sprayer**

A compact and efficient knapsack outfit. Will develop a 40-lb. pressure with a dozen strokes of the pump lever. Has a 30-inch spray rod. Capacity about 4 gals. Weight 16 lbs. Price \$20.00.

**Pomona Barrel Sprayer**

The best orchard barrel sprayer. It is unusually powerful and of large capacity, fully capable of supplying four leads of hose and eight nozzles. There is nothing about the Sprayer to get out of order, and with ordinary care it will last a lifetime.

- Pump, with Agitator and Hose Coupling** . . . . . \$22.00
- Outfit C.** Pump with Agitator, one lead 15 ft. Discharge Hose, and Mistry, Jr. Nozzle . . . . . 28.25

**Outfit D.** Pump with Agitator, two leads, 15 ft. each, Hose and two Mistry Jr. Spray Nozzles . . . . . 34.50

**Barrel furnished for above and mounting** . . . . . 11.00

**Bamboo Extension.** 10 ft. long A brass tube inserted in a bamboo rod. Fitted with brass stop-cock . . . . . 4.50

**Iron Pipe Extension.** 8 ft. long. Fitted with stop-cock . . . . 3.50

**Spray-Rite Knapsack Sprayer.** A convenient sprayer for garden or greenhouse work. Tank holds 4 gals., made with brass and pump bronze. Has 3 feet of 3/8-inch hose, brass strainer and automatic shut-off nozzle. Fig. No. 1002. \$18.75.

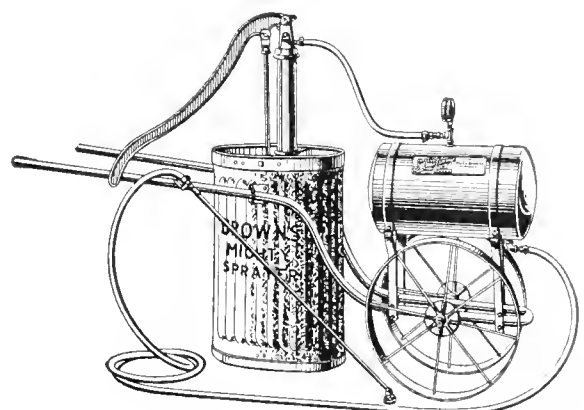

Brown's Mighty Sprayer

**Brown's Mighty Sprayer.** A fifteen gallon wheelbarrow sprayer with corrugated bucket, heavy duty pump, high pressure air tank, truck frame and 18-inch wheel. Eight feet of hose and 2 ft. 8 inch iron extension. Wheels 18 in., 2 1/2-in. tire. Complete sprayer, \$35.50.

**SPRINKLERS—LAWN**

**California.** The most popular Sprinkler. It has four brass arms and is mounted on a sled, so that it can be easily dragged over the lawn without turning off the water. Price, \$2.00.

**C. B. G.** The C. B. G. Sprinkler is built on the principle of the tangential spray. Simple in construction and cannot get out of order. Each, 40c.

**Double Rotary.** This Sprinkler will cover an area up to 80 feet in diameter, giving an equal distribution over the entire area; it is easily regulated to cover smaller areas. It works best on a water pressure of not less than 30 pounds. The gears of hardened steel and bronze are enclosed and run in oil. \$12.50 each.

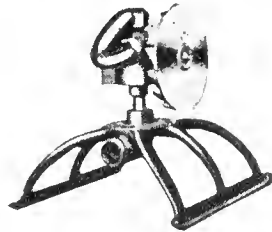

Double Rotary.

**Fountain.** Very simple in construction. Cannot rust or get out of order. Will not injure the lawn. Requires only ordinary pressure of water. Price 70c each.

**Mac's Circular Tree.** A sprinkler, specially designed to water trees at one operation. It saves time, labor, and money. It will water your trees more efficiently than by any other known method.  
 No. 1 Four feet in diameter ..... \$17.50  
 No. 2 Three feet in diameter ..... 15.00  
 No. 3 Two feet in diameter ..... 13.75  
 Add \$5.00 each if Quick-as-Wink couplings are wanted.



Mac's Circular Tree.

**Non Clog No. 3.** Operates on any pressure and at any elevation. Revolving or stationary and easily adjusted to cover squares. Brass head, 10 inches long; height, 6 inches. Brass non-clogging tips. Each \$3.00.

**Non Clog, Jr., No. 4.** Similar to the above with head 7 3/4 inches long. Height, 5 3/4 inches. Each \$1.50.

**Rain King.** The Rain King is a real innovation in the sprinkler line. A most wonderful variety of uses. Circular or stationary spray, fine or coarse, fast or slow. Small, compact, easily handled. Simple adjustments. Model D. Each \$2.00.

**Rain King. Model G.** Can be set for fast or slow revolutions. Has one long arm with adjustable nozzle. Will throw spray from 15 to 60 feet on normal pressure. Each \$3.50.

**Rain King. Model E.** For estates and golf courses. One long revolving arm with a spinning vibrator that will throw more water and further than any other sprinkler. With roller base \$17.50.

**Rip Sprinkler.** Makes a rain-like spray. Spike to place in ground. A perfect sprinkler. Each \$1.00.

**Rip. Double Connection Sprinkler.** For connecting to hose in series. Each \$1.25.

**The Tu Way.** Can be used as a circle sprinkler or by giving the nozzle a half turn you have a sprinkler for a half circle to use for borders without wetting the sidewalk. Each \$1.25.

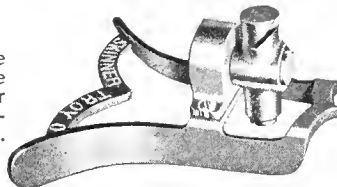

The Tu Way.

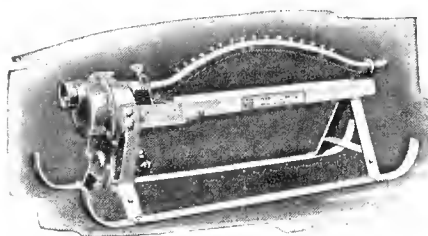

Water Fan.

**Water Fan.** The Water Fan is an automatic oscillating rain making machine. It is light, weight only 6 1/2 lbs., strongly built of brass and phosphor bronze and will work on a low or high pressure. No. 7 will cover an area of 40x45 feet with fine gentle even rain-like distribution. Each \$15.00.

**STAKES.** (See Plant Stakes and Canes, Pages 80 and 86).

**STAKES, HYACINTH.** Green. 18 in. long. Doz. 5c, 100 40c, 1000 \$3.50.

**STICKS, Match.** 18 in. long 1000 \$3.00.

**STYPTIC.** To prevent bleeding of vines. Bottles, each \$1.25.

**SULPHUR VAPORIZER, Campbell's Patent.** (See Fumigators, Page 82).



**SYRINGES, GARDEN, Brass.**

**No. C,** length 14 1/4 in., diam. 1 1/4 in., one spray rose and stream. Each \$4.50.

**No. 11,** length 18 in., diam. 1 1/2 in., two spray roses and one stream. Each \$6.00.

**No. 5,** length 18 in., diam. 1 1/2 in., two spray roses and one stream, extra heavy and strongly mounted. Each \$8.00.

**Goosenecks.** For syringes. Each \$1.25.

**TAN BARK** for walks. Per ton \$30.00.

**TARRED FELT DISCS.** For Cabbage plants. 100 50c, 1000 \$4.00.

**TENNIS NETS.** Single court, 27x3 ft. Double court, 36x3 ft., canvas bound. Prices on application.

**TENNIS MARKER, No. 0 Dry Marker.** For making tennis courts. \$3.50.

**THERMOMETERS.**

**Mushroom Bed.** Wood with brass point, metal scale. Each \$3.75.

**Mushroom Bed.** Wood with brass point. \$2.00.

**Brooder, "Tycos."** Each \$1.00.

**Distance Scale.** Metal frame. Each \$1.00.

**Household.** Wood frame. 8 or 10 in., 75c to \$1.50.

**Incubator, Tycos.** Each 75c.

**Japan Tin Case, Metal Scale.** 8 in. 90c, 10 in. \$1.10.

**Porcelain Scale.** For conservatory. Each \$1.50.

**Self-Registering, "Tycos."** Burnished copper frame. Size 10 in. \$7.00.

**Self-Registering.** Imported, metal frame, 10 in. porcelain scale. Each \$3.00.

**Temprite.** Heavy metal, for greenhouse or outside. White with black figures. 9 in. Each \$1.25.

**Window.** Round glass with metal hangers. 8 in. Each \$2.00.

**Magnets.** For self-registering. 75c.

**TINFOIL.** Lb. 30c, violet or green, lb. 75c.

**TOOL SETS.** Fork, spade, hoe and rake. Set \$3.50.

**Ladies' Garden Beauty.** Hoe, rake and trowel. \$1.00.

**TOOTHPICKS.** Wired. 1000 75c.

**TORCHES, Asbestos.** For burning tent caterpillars. Each 60c.

**Collins' Caterpillar Torch.** A swinging lamp with attachment to pole with pan to catch the caterpillars that fall. Torch and catcher, \$1.00, 12 ft. pole in 3 sections, \$1.00.

**TOMATO SUPPORTS.** Heavy galvanized wire rings. Each 40c, doz. \$4.00. (See also Page 87).

**TREE BANDS.** Used for applying Tree Tanglefoot on the trunks of trees. Roll of 50 feet. Each \$1.00.

**TREE SCRAPERS.** Large iron with handle. Each \$1.25. Extra blades 60c.

**TRELLIS.**

**Fan Shaped.**

Very popular for training pot plants for windows or conservatories. All painted dark green.

Height	Width	Each	Height	Width	Each
18 in.	6 in.	.....\$0.30	30 in.	13 in.	.....\$0.60
24 in.	10 in.	......45	36 in.	16 in.	..... 1.00

**TROWELS.**

**Bulb.** Used for planting all kinds of bulbs and plants. Each 60c.

**English.** Finest quality throughout.

Short handle ..... \$0.85

Long handle ..... 1.25

**Lifetime.** Best steel, unbreakable neck, with wooden handle .75



**Steel.** 6 in., 75c, 7 in. 80c,

8 in. 90c.

**Cast Steel.** Each 35c.

**Maynard.** Heavy, one-piece steel. Each \$1.10.

**Transplanting or Slim Jim.** 6 in. 25c, large 8 in. 30c.



TUBS, PLANT. Marshall's Plant Tubs.



Made from selected Virginia white cedar, bound with electric welded wire hoops (galvanized). Painted drop handles if wanted at 30c per pair. Inside measurements.

No.	Diameter	Height	Each	No.	Diameter	Height	Each
No. 3	8 in.	8 in.	\$0.75	No. 8	13 in.	12 in.	\$2.00
No. 4	9 in.	9 in.	.85	No. 10	15 in.	14 in.	2.50
No. 5	10 in.	9 in.	1.00	No. 12	17 in.	16 in.	3.50
No. 6	11 in.	10 in.	1.30	No. 14	19 in.	18 in.	4.25

All inside measurements.

New York Cedar.

No.	Diameter	Height	Each
No. 00	32 in.	26 in.	\$21.00
No. 0	30 in.	24 in.	18.50
No. 1	28 in.	22 in.	16.00
No. 2	26 in.	20 in.	13.50
No. 3	24 in.	18½ in.	8.50
No. 4	22 in.	17 in.	7.00
No. 5	20 in.	16 in.	6.00
No. 6	18½ in.	15 in.	5.00
No. 7	16½ in.	14 in.	4.50
No. 8	15½ in.	13 in.	3.75
No. 9	14 in.	12 in.	3.25
No. 10	12 in.	9½ in.	2.75

Painted green. Outside measurements.

Feet for the above tubs 50c each extra.

Richmond Cedar Plant Tubs

Made with Virginia White Cedar, with metal feet, extra heavy flat steel hoops and metal handles.



No.	Top	Bottom	Depth	Each
1R.	12 in.	9¾ in.	10⅝ in.	\$2.15
2R.	13 in.	10¾ in.	12¾ in.	2.75
3R.	14½ in.	12 in.	14¾ in.	3.50
3½R.	16½ in.	14½ in.	15¾ in.	4.50
4R.	19½ in.	17¼ in.	16½ in.	5.00
5R.	22½ in.	20¼ in.	18½ in.	6.50

Painted green, with hoops and handles painted black. Inside measurements.

**TUBS, Porch.** Made with cedar, painted green, welded fire hoops.  
 No. A. 9 in. wide, 6½ in. deep.....Each \$0.35  
 No. B 10½ in. wide, 5 in. deep.....Each .50  
 No. C. 10 in. wide, 6½ in. deep.....Each .50  
 Inside measurements.

**TURFING IRONS.** English, with handles. Each \$8.00.  
 American. With handles. Each \$2.75.

**TWINE.** Cotton. White, per lb. \$1.00.  
 Green Smilax. Box of 8 balls, \$1.50.  
 Hemp. All sizes. Per lb. \$1.25.  
 Jute. Three-ply in ½-lb. balls. Lb. 75c. Green, lb. \$1.00.  
 Marline (Tarred Twine). Lb. 75c.  
 Marline. Small size. Per ball \$1.00.  
 Silkline. Spool 50c, 8 spools \$3.50.  
 Plan-Tie. An English tying material. Color green. Spool of 300 ft. 25c, doz. \$2.50.

**VASES, Flower, Galvanized.** Made with heavy galvanized metal, will not break or rust.

No.	Width	Depth	Each	Doz.
No. 1	5½ in.	9½ in.	\$.50	\$5.00
No. 1A	6 in.	12½ in.	.70	7.00
No. 2A	6½ in.	15 in.	.90	9.00
No. 3	8 in.	17 in.	1.10	11.00
No. 4	8 in.	20 in.	1.50	15.00

Painted green, 25c each extra.

VASES, Fiber Ware.

Made with indurated fiber which is light, handy and durable. Smooth mahogany finish.

No.	Width	Depth	Each	Doz.
44	3½ in.	9 in.	\$1.35	\$15.00
1	6 in.	10 in.	1.75	20.00
33	4¾ in.	12 in.	1.95	22.00
0	8¾ in.	13½ in.	2.50	28.00
22	4½ in.	15 in.	3.50	40.00
11	6 in.	18 in.	5.00	55.00

Inside measurements.

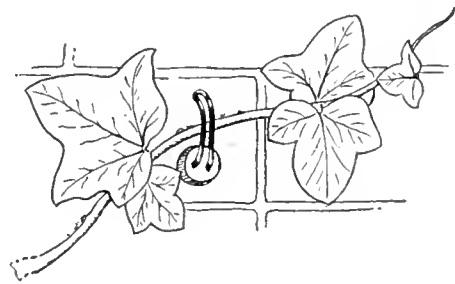

VINE GUIDE AND SUPPORT

For training and supporting IVY, small fruiting trees and all other vines, etc. on brick walls or any other surface without defacing it. Colors: Red, gray or white. Per box of 25 with paste \$1.00.

**VYN-TACH HOOKS.** Used for supporting vines to walls and fences. Hooks for wood. Box of 25 for \$1.00. Hooks for walls. Box of 25 with dryvins and drill \$2.00.

WATERING POTS or CANS.

**French Pattern Oval.** With long spout and brass bow handle. 2 roses. 6 qts. \$7.00, 8 qts. \$7.50, 10 qts. \$8.00, 12 qts. \$8.50.

**Hawe's Pattern.** English made. Valuable for watering fine seeds or greenhouse and garden work. One very fine and one coarse rose. Made with heavy material, painted red. No. 2, 4 qts. \$7.00. No. 3, 6 qts. \$8.00. No. 4 8 qts. \$9.50. No. 5, 10 qts. \$10.75.

**Extra roses.** Each \$1.00.

**Law or Strawberry Pattern.** One fine rose. 4 qts. \$4.50.

**Philadelphia Pattern, Round.** With two copper-faced roses. 4 qts. \$5.00, 6 qts. \$6.00, 8 qts. \$6.50, 10 qts. \$7.00, 12 qts. \$7.50.

**Extra Roses.** Fine or coarse. Each 70c.

**Galvanized Watering Pot.** It is made with heavy galvanized material. 6 qts. 80c, 8 qts. \$1.00, 10 qts. \$1.10, 12 qts. \$1.20.

**Copper.** Useful for conservatory. 2 qts. \$1.50.

WEEDERS

**"Cleveland."** Can be used easily and without stooping. Each \$1.25.

**Dando-Killrite.** Used for dropping liquid on dandelions, etc. Each \$3.00.

**Dando-Killrite Filler** for above. Can 60c.

**Excelsior.** Five-claw fingers. Each 20c.



**Grip-Root.** It grips the weed root inches under the ground and removes it without destroying the sod. Each, 15c.

**"Eureka."** Very useful for garden purposes. Each 60c.

**Speedy.** A light weight long handle weeder with three- or four-inch stationary prongs of tempered steel. As a cultivator or weeder it is equally effective. 3 prong, each 75c. 4 prong, each \$1.00.



**Killer Kane.** An ideal applicator for using gasoline or kerosene on dandelions, plantain and other weeds in lawns. Each \$2.25.

**Lawn.** For removing docks, dandelions, etc., can also be used as an Asparagus knife. 50c.

**Lifetime.** A very handy weeder. Each 75c.

**Magic "D."** 6 in. handle, weeder and hoe combined. Four prongs. Each 50c.

**Magic "B."** 18 in. handle. Three prongs. Each 25c.

**Magic "H."** Weeder and hoe combined. Handle, 48 in. Four prongs. Each \$1.25.

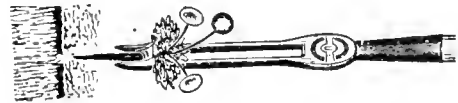
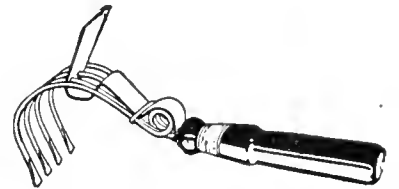

**The Out-U-Come.** A useful tool for pulling dandelions, etc., from lawns. Each \$1.00.

WHEELBARROW.

**Leaf Rack.** Most convenient for gathering leaves, cut grass and rubbish. Capacity, 10 bushels, made of galvanized wire, with wood base to stand on wheelbarrow. Each \$9.00.



## WHEELBARROWS

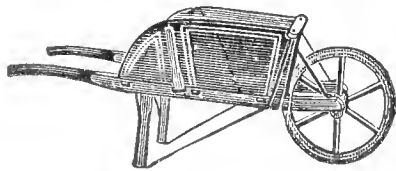

**Garden.** All nicely painted, iron leg braces thoroughly bolted. Wheels steel with 3-inch treads.

- No. 3. Small size. Box 24 in. long, 20 in. wide at handles... \$7.50
- No. 4. Medium size. Box 26½ in. long, 20 in. wide at handles... 9.00
- No. 5. Large size. Box 28 in. long, 24 in. wide at handles... 10.00

### Rubber Tired Garden Wheelbarrows

- No. 4. With Rubber Air Tire, 16 in. high by 4 in. diameter.. 17.50
- No. 5. With Rubber Air Tire, 16 in. high by 4 in. diameter.. 18.50

**Greenhouse Wheelbarrow.** A very narrow style for use in greenhouses. Extreme width at handles only 20 inches..... 12.00

**Metal Garden or Golf Barrow.** Designed especially for garden or lawn work having 4 in. tread on metal wheel and wide faced shoe on legs. The metal tray holds 3½ sq. ft., is balanced to wheel easily, dumps quickly and will give lasting service..... 12.00

## WINDOW BOX. The "Savo".

Self-watering and sub-irrigating for windows, porches, sun parlors, etc.

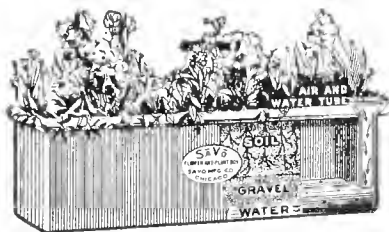

	Height	Width	Length	Each
Model A.	8 in.	9½ in.	23 in.....	\$3.00
Model B	8 in.	9½ in.	29 in.....	3.50
Model C	8 in.	9½ in.	35 in.....	4.00
Model D	8 in.	9½ in.	41 in.....	4.50

## WIRE, Annealed for Stemming.

		Per lb.
No. 23. Coarse.	18 in. lengths.....	\$0.30
No. 26. Coarse.	12 in. lengths.....	.40
No. 34. Fine hair	12 in. lengths.....	.60

## "RAT CORN"



**No odors or smells.**

It mummifies them. No matter where they die they simply DRY UP. Positively do not smell.

Rat Corn is a new and scientific discovery, and without doubt the greatest rat destroyer

in the world; the only one that kills rats without any bad, dangerous or disagreeable effects. A trial will convince you. 25c, 50c and \$1.00 each.

## RAT POISON "ZELIO PASTE"

A powerful poison for rats, mice and squirrels. The paste is easily applied to bread and is without taste or odor. 2 oz. tubes, 50c; 8 oz. cans, \$1.50.

## ZELIO POISON WHEAT

Used for Field Mice, Mice and Rats. Very effective and a sure destroyer. 1 oz. 25c; lb. \$2.00.

## LEGUME CULTURES

**Legume Culture,** for inoculating legume seeds, or the soils in which they are planted, with nitrogen-fixing bacteria. Increases crop yield. For Beans, Peas, Vetches, Soy Beans and all Clovers. When ordering state for which legume the inoculant is wanted.

Alfalfa and Clovers		Soy Beans, Cowpeas, Vetch, Peas and Beans, Etc.	
SMALL SEED VARIETIES		LARGE SEED VARIETIES	
2½-bu. unit .....	\$1.25	5-bu. unit .....	\$1.25
1 -bu. unit .....	.60	2-bu. unit .....	.60
½-bu. unit .....	.30	1-bu. unit .....	.30

When ordering, be sure to state what crops you wish to inoculate, also number of bushels you will sow.

## WEED KILLERS

**ATLACIDE WEED KILLER** (Non-poisonous). An effective Weed Killer in powder form which can be dusted on weeds and grasses. 1-lb. duster kills 100 sq. ft. of weeds, each 50c. 3½-lb. duster each \$1.50, 15 lbs. \$3.50, 50-lb. drum of powder \$7.00.

**MARSHALL'S WEED KILLER.** Destroys weeds in paths, roads and gutters. Dilute one part Weed Killer to forty parts water. Does not discolor cement or stone. Qt. 60c., gal. \$1.50, 5 gals. \$5.00, 30 gals. \$23.00, 55 gals. \$40.00.

**HERBICIDE WEED KILLER.** A liquid preparation for the killing of every kind on roadways, paths, gutters, tennis courts. One gal. makes 40 gals. liquid. 5 gals. \$6.50, 10 gals. \$10.00, 30 gals. \$25.00, 55 gals. \$40.00.

**WETOX.** A poison to weeds and a tonic to plants. When applied it acts as a positive control of all types of weeds in lawns or gardens. It will not harm the grass or cultivated plants. Can be applied with a sprayer or sprinkler. Qt. \$1.25, gal. \$3.50.

## POULTRY SUNDRIES

**BUCKEYE COAL-BURNING BROODERS.** Buckeye Coal-Burning Brooders are guaranteed to be exactly as represented and to be absolutely satisfactory when operated with maker's instructions.

**No. 117.** Capacity 350 Chick. Hover 42 in. diameter. Coal capacity 23 lbs., \$15.00.

**No. 118.** Capacity 500 chicks. Hover 52 in. diameter. Coal capacity 35 lbs., \$17.50.

**No. 119.** Capacity 1,000 chicks. Hover 56 in. diameter. Coal Capacity 58 lbs., \$22.50.

### BUCKEYE OIL BURNING BROODERS

**No. 27A. Blue Flame Brooder.** Capacity up to 200 chicks. \$14.50.

**No. 28A. Blue Flame Brooder.** Capacity up to 350 chicks. \$15.50.

**No. 29A. Blue Flame Brooder.** Capacity 500 chicks. \$18.50.

## Buckeye Incubators

<b>Model 65.</b> Capacity 75 eggs .....	\$18.50
<b>Model 66.</b> Capacity 143 eggs .....	39.50
<b>Model 67.</b> Capacity 286 eggs .....	57.75
<b>Model 68.</b> Capacity 416 eggs .....	76.50
<b>Model 69.</b> Capacity 576 eggs .....	97.50

Models 66 to 69 are furnished with Automatic Egg Turners and are approved by the National Board of Fire Underwriters.

Descriptive catalog of the above mailed on request.

**Egg Boxes. Paper.** Convenient for carrying a dozen eggs to local customers. Doz. 30c., 50 for 90c., 100 \$1.75, 1,000 \$16.00.

**Egg Crates. Metal.** Indestructible; pays for itself in a few shipments; lasts for years; makes interchangeable shipping easy. Buy yours now and realize more money for your eggs. Your friends want them.

1-dozen size.....	\$1.00	4-dozen size.....	\$1.75
2-dozen size.....	1.25	6-dozen size.....	2.00
3-dozen size.....	1.50	9-dozen size.....	2.50

Add postage for 3 lbs. to the price for each 150 miles if wanted by mail.

**Egg Preserver.** Water glass. One quart with water for 15 doz. eggs. Gal. \$1.25.

**Poultry Catching Net.** A safe and convenient way of catching poultry and pigeons. Nets are 24 inches mounted on a 16-inch wire ring with a 5¼-foot handle. Each \$1.75.

**Nest Eggs, China.** 3 for 10c., dozen 35c.

**Poultry Knives.** "Pilling" for killing poultry ..... .50

## AREOIL BURNER

A combination Weed Burner, Disinfecting and Thawing Torch. It throws a powerful, windproof, smokeless flame, 3 inches in diameter and 30 inches long. Can be used with kerosene or gasoline, is easy to operate, absolutely safe and very economical.

Complete with 4 gal. tank, 7-foot hose, pressure gauge and burner, \$20.00.

Burner only to use with your own Compressed Air Sprayer including hose and fittings, \$12.50.



# Fertilizers

## GENERAL GARDEN FERTILIZER

A fertilizer adapted for vegetables, flowers and other garden crops. Use at the rate of 1000 lbs. per acre. Used between the rows when plants are growing about 3 pounds for 100 feet. Nitrogen 5%, available phosphoric acid 10%, potash 5%. 100 lbs. \$3.50, 1000 lbs. \$30.00, ton \$55.00.

## GENERAL LIST OF FERTILIZERS

### BLOOD AND BONE

It is of value for garden crops, fruit trees, grape vines, etc. For garden crops, drill in 300 to 500 lbs. per acre. 50 lbs. \$3.00, 100 lbs. \$5.50.

### BONE MEAL

This bone meal is made from the best quality of bone and finely pulverized. Valuable for top dressing lawns, roses, flowers and vegetables. Apply about 1,000 lbs. per acre or 5 lbs. to 100 sq. ft. 5 lbs. 30c, 10 lbs. 55c, 50 lbs. \$2.25, 100 lbs. \$3.75, 200 lbs. \$6.50, ton \$60.00.

### BONE, PURE RAW

A coarser ground grade of bone than the Bone Meal. 100 lbs. \$4.00, ton \$65.00.

### BOVUNG

A plain, dried Cow Manure combining the chemical values of fertilizer with the organic and physical values of manure. 50-lb. bags \$1.75.

### CARNATION FOOD

This Carnation food is not a chemical stimulant, but an evenly balanced ration to produce a natural growth, vitality and productiveness. 100-lb. bag \$8.00.

### CATTLE MANURE (SHREDDED)

A natural fertilizer for garden crops and lawns. 100 lbs. \$4.00, ton \$70.00.

### CHARCOAL

Useful for sweetening sour soils or mixing with patting soil. Coarse or fine. 100 lbs. \$4.00. Very coarse, per bag \$3.00.

### CLAY'S FERTILIZER

Highly recommended by leading horticulturists in the cultivation of flowers, fruits and vegetables for exhibition, etc. 56 lbs. \$7.00, 112 lbs. \$13.00.

### CORN FERTILIZER "AGRICO"

Suitable for Corn, garden crops, small fruits, etc. Nitrogen, 3 per cent; available phosphoric acid, 10 per cent; potash, 6 per cent. 100 lbs. \$3.25, ton \$50.00.

### DAHLIA FERTILIZER

"Agrico" brand of fertilizer containing eight per cent of Phosphoric Acid and 7 per cent Potash, the requirements for growing large Dahlias. 100-lb. bag \$4.00.

### DRIED BLOOD

For top dressing, mixing with the soil and applying in liquid form, it is one of the best and safest nitrogenous fertilizers. 100 lbs. \$6.00.

### FLORANID (UREA)

An organic nitrogen fertilizer for flowers, fruits, vegetables or lawns. A quick acting stimulant containing 46% of available nitrogen. 1-lb. tin 25c, 10 lbs. \$1.50, 25 lbs. \$2.75, 100 lbs. \$9.00.

### FERTILIS TABLETS

A concentrated fertilizer in tablet form, easy to use, clean and odorless. 40 tablets 25c, 100 tablets 60c, 1000 tablets \$3.00.

### HUMUS

Valuable for all garden purposes, including lawn and greenhouse plants. 100-lb. bag \$2.50, 500 lbs. in bags \$10.00, ton in bags \$30.00. f. o. b. Warbasse, N. J.

### LIME, HYDRATED

For correcting acids in soils use 10 lbs. for 200 sq. ft. of ground. 10 lbs. 30c, 50 lbs. \$1.10, 100 lbs. \$2.00, ton \$30.00.

### LIMESTONE, GROUND

A very finely screened ground limestone. Useful for sour soils and to correct improper conditions of the soil. Tan \$11.00, f. o. b. West Stockbridge, Mass. or Lime Crest, N. J.

### MILORGANITE

A remarkable fertilizer for grass feeding and garden plants. Use 3 to 5 lbs. per 100 sq. ft. 100 lbs. \$3.00.

### MULTI-MULCH

A useful top dressing for lawns and gardens. 25 lbs. \$1.00, 50 lbs. \$1.75, 100 lbs. \$3.00.

### NITRATE OF SODA

It is valuable for grain, corn, beets, potatoes, grasses, peas, beans, clover etc. Being extremely soluble it should not be applied until the plants are above ground. 1 lb. 15c, 5 lbs. 40c, 10 lbs. 75c, 50 lbs. \$2.50, 100 lbs. \$4.25.

## LAWN AND GARDEN FERTILIZER

A scientific blending of organic compounds that offer immediate nourishment to the grass and plants under the action of the soil bacteria. Use 25 to 35 pounds per 1000 sq. ft. Nitrogen 7%, available phosphoric acid 6%, potash 6%. 500 lbs. \$20.00, ton \$70.00. 100 lbs. \$4.00.

### NITROPHOSKA

A new, complete concentrated fertilizer adapted to all crops, fruits and lawns. It is water-soluble and is completely available. It contains 15% Nitrogen, 30% Phosphoric Acid and 15% Potash. A total plant food of 60% or three times the value of a 6-10-5 fertilizer. 2 ozs. 10c, 1 lb. 25c, 10 lbs. \$1.50, 25 lbs. \$2.75, 50 lbs. \$4.75.

### POTATO FERTILIZER "AGRICO"

Suitable for Potatoes, root crops and garden truck. Nitrogen, 4 per cent; available phosphoric acid, 8 per cent; potash, 7 per cent. 100 lbs. \$4.00, ton \$55.00.

### ROSE FOOD

Contains just what is needed for the Rose. It is a properly balanced, organic Rose food and entirely takes the place of bone meal, sheep manure or tankage. It stimulates the vitality of the plant and produces a larger crop of more perfect blooms. 100 lbs. \$8.00.

### SALT, AGRICULTURAL

Used for top dressing Asparagus beds, etc. 100 lbs. \$2.00.

### SHEEP MANURE PULVERIZED

A rich, pure and natural manure. Excellent as a top dressing for lawns, and mixing with the soil for greenhouse plants—one part manure and six parts of soil. 5-lb. pkg. 50c, 10 lbs. 90c, 50 lbs. \$2.25, 100 lbs. \$4.00, ton \$60.00.

### SMITH'S CHRYSANTHEMUM MANURE

For Mums, Roses, Carnations, Sweet Peas and other greenhouse plants. 50-lb. bags \$2.75, 100 lbs. \$5.00.

### SOOT, IMPORTED SCOTCH

A fertilizer for stimulating growth and giving a rich, dark foliage; also an excellent remedy against slugs, grubs and cutworms. Bag of 100 lbs. \$6.00.

### STERILOAM

Prepared soil for sowing seeds in and transplanting seedlings. 10-lb. tin \$1.00, 50 lbs. \$3.50, 100 lbs. \$6.00.

### STIM-U-PLANT

A plant food in tablet form for fertilizing all kinds of growing plants in the home or garden. Tablets should be used in the soil or dissolved in water and applied to the soil. 30 tablets 25c, 100 tablets 75c, 500 tablets \$2.50, 1000 for \$3.50.

### SULPHATE OF ALUMINA

Used for Rhododendrons, Azaleas, Laurel and other shrubs that require an acid soil. 25 lbs. \$1.50, 50 lbs. \$2.50, 100 lbs. \$4.50, 200 lbs. \$7.50, ton \$65.00.

### SULPHATE OF AMMONIA

For lawns, home gardens and fruits. It feeds the grass and starves the weeds. 5 lbs. 50c, 25 lbs. \$1.50, 100 lbs. \$5.00.

### SUPERPHOSPHATE

For mixing with other fertilizers to increase the phosphoric acid content. For farm crops, 16 per cent available phosphoric acid. 200 lbs. \$3.50, ton \$30.00.

### TOBACCO FERTILIZER

A double action product—a natural fertilizer and insecticide. Controls aphid, cutworms and all soft-bodied insects. 100-lb. bag \$4.25.

### TOP SOIL

Hand screened and carefully fertilized ready for use. 100-lb. bag \$1.50, 5 bags \$7.00.

### TREE FERTILIZER. "AGRICO"

Used in the spring for fertilizing trees. It is best applied by making holes with a crowbar to reach the roots. Bag of 100 lbs. \$4.50, ton \$70.00.

### VIGORO (SWIFT'S)

A specially prepared plant food for lawns, flowers, shrubbery and trees. Vigoro has no unpleasant odor and can be conveniently applied at any time. 5 lbs. 45c, 10 lbs. 85c, 25 lbs. \$1.50, 50 lbs. \$2.50, 100 lbs. \$4.00.

### WOOD ASHES

For lawns, gardens and fruits, hardwood ashes are unequalled; 1 to 2 tons per acre. 100 lbs. \$3.00, ton \$50.00.

NOTICE.—We deliver free by Express or Freight (at our option) all orders for Fertilizer of \$3.00 or over, when cash accompanies the order, within a radius of 50 miles of New York City.

# INSECTICIDES

**AGRI-PAX.** A new contact insecticide, founded upon the toxic principle of pyrethrum. It will kill Japanese beetle, rose beetles, aphids, thrips, etc. One of the best sprays for Dahlias. Quart tin \$1.00, gal. \$3.00, 5 gals. \$12.00.

**ANSECT** (Rose Bug Killer). Highly effective when used on rose bugs, many hard-bodied insects, red spider, mealy bug, and other garden pests. Use one part in thirty to fifty parts of water. Will not discolor the foliage of plants or affect the flowers. 4 ozs. 30c, pint \$1.00.

**APHINE.** Has no equal for the destruction of green, black or white fly, thrips, red spider, mealy bug, caterpillars, scale and other insects and blights. Use one part to forty parts of water. Qt. \$1.00, gal. \$3.00.

**ANT KILLER, CYANOGAS.** Simply enlarge entrance to nest with a stick and allow small amount of Cyanogas to flow into the hole. The queen and worker ants are killed in a few minutes. Can with spout, 30c.



**ANT BAIT, Magikil Jelly.** A jelly bait vastly superior to powders and syrups. Clean to use, quick to kill and sure death to all ants. Small safety traps 10c, small tube 35c, 8-oz. tube \$1.75.

**ANT TRAP "THALITE".** The simplest, safest, and most effective trap. The bait is contained in a metal trap. Each 25c.

**ANT KILLER.** For destroying ants in grass, walks, buildings, etc. 4 1/2 oz. sifter can 50c.

**ANTROL.** The Antrol System exterminates the commonly known "house ant"—the species that infests kitchens and eats food and sweet substances.

Prices—Antrol sets containing 4 containers and 1 4-oz. bottle of syrup, 50c; Antrol extra containers, each 10c; Antrol syrup, 4-oz. bottle 35c, pints 85c.

**ARSENATE OF LEAD, Powdered.** Better than Paris Green and does not burn foliage. Can be used either wet or dry for dusting. With water use 1 lb. to 15 or 25 gals. Lb. 40c, 5 lbs. \$1.50, 10 lbs. \$2.75, 25 lbs. \$5.50, 100 lbs. \$20.00.

**BORDO-LEAD.** See Key-Cide.

**BORDEAUX MIXTURE, Powder.** 12 per cent copper. Used same as Bordeaux Mixture, also for dusting dry. For spraying use 1 lb. to 8 gals. water. Lb. 40c, 5 lbs. \$1.60, 25 lbs. \$5.50, 100 lbs. \$20.00.

**BOR-TOX.** A preparation of paste that kills boring insects when injected into their burrows. 2-oz. tubes with spout. Each 75c.

**BUG DEATH IMPROVED.** A non-poisonous Insecticide and Fungicide. Can be used safely on Vegetables, Fruits and Flowers. 1 lb. 25c, 5 lbs. \$1.00, 12 1/2 lbs. \$2.25, 100 lbs. \$14.00.



**COPPER LIME DUST.** For checking botrytis blight on Lilies and other plants. Lb. 50c, 5 lbs. \$2.25.

**COPPER SOLUTION.** For mildew, pear and apple scab, rust on Carnations and Violets. Qt. \$1.50, gal. \$4.50.

**CUPROXIDE.** The Red Copper Oxide for seed treatment to prevent damping off. Lb. \$1.00, 5 lbs. \$4.00.

**CUT WORM KILLER.** This is a coarse powder for sprinkling near the plants to be protected. It is harmless to birds or chickens. 1 lb. is sufficient for 175 plants or 100 ft. of drill. Lb. 50c, 5 lbs. \$2.00, 25 lbs. \$7.50.

**CYANOGAS A-DUST.** A gas-producing powder in world wide use to kill rats, woodchucks, moles, and other burrowing pests. 1 lb. 75c, 5 lbs. \$3.00, 25 lbs. \$10.00, 100 lbs. \$30.00.

**CYANOGAS DUSTER.** Each \$1.00.

**CYANOGAS G-FUMIGANT.** Scatter it over the greenhouse walks, and close the house for the night. One cent more than pays the cost of fumigating 1,000 cubic feet in a greenhouse. Thrips, bulb flies and all bulb-infesting insects yield to Cyanogas. Does not rot the bulbs, but has a beneficial effect. Ask for "Cyanogas Handbook for Greenhouses and Nurseries"—contains complete directions. 5 lbs. \$3.25.



**EVER GREEN.** A non-poisonous insecticide. A very effective spray for all kinds of insects. Harmless to animals or birds. Recommended for the Japanese beetle. One pound makes 100 gals. spray. 1 oz. 35c, 6 ozs. \$1.00, 16 ozs. \$2.00, gal. \$11.00.

**FORMALDEHYDE DUST.** A seed and soil treating compound to prevent damping off. 1 lb. 60c, 5 lbs. \$2.00.

**FUNGTRÖGEN.** A complete spray for mildew and black spot on Roses. It will not disfigure the leaves or petals. Pint \$1.25, qt. \$2.00, gal. \$6.00.

**GRAPE DUST.** For prevention of mildew on Roses, Grapes, Gooseberries, etc. 5-lb. pkg. \$1.50, 100 lbs. \$22.00.

**HELLEBORE POWDER.** For rose slugs, currant worms, etc. Dust on with gun or bellows while the foliage is moist. Lb. 50c, 5 lbs. \$2.50.

**HORTO GAS.** A preparation of treated crystals which evaporate readily forming a gas. Highly effective against gladiolus thrips, mites, mealy bug, red spider, white fly and soil insects. 5 lbs. \$4.00.

**KAYSO.** Used to keep spray from washing off and prevent injury to foliage. 2 lbs. 50c, 24 2-lb. pkgs. \$12.00, 100 lbs. \$20.00.

**KEY-CIDE POWDER** (Bordeaux and Arsenate). A combined insecticide and fungicide. Kills bugs and prevents blight, rot, mildew and fungus. Can be used for wet spraying or dusting for fruits, vegetables and flowers. 1 lb. makes 7 gals. liquid. Lb. 40c, 5 lbs. \$1.75, 25 lbs. \$6.50, 100 lbs. \$27.50.

**LEMON OIL.** For destroying mealy bugs, scale, thrips, red spider, etc. Qt. \$1.25, gal. \$3.50.

**LETHANE 440.** An effective insecticide control for such pests as mealy bug, red spider, thrip, midge, etc. Qt. \$3.00, gal. \$8.50.

**LIME-SULPHUR, Liquid.** For spraying fruit trees, etc. 5 gals. \$4.00, 30 gals. \$13.50, barrel, 50 gals., \$20.00.

**LIME-SULPHUR, Dry.** Used for all scale insects as a dormant spray. Has all the effectiveness of Liquid Lime-Sulphur and is much easier to handle. 1 lb. makes from 4 to 10 gallons. Lb. 40c, 5 lbs. \$1.75, 10 lbs. \$3.00, 25 lbs. \$5.50, 100 lbs. \$17.00.



**MAGNESIUM ARSENATE.** Especially recommended for combating the Mexican bean beetle. 2 lbs. 80c, 100 lbs. \$35.00.

**MEXOGEN.** Kills and repels Mexican bean beetle, including the adult, larvae and eggs. 1/2 pt. 75c, qt. \$2.00, gal. \$6.00.

**MO-LO.** Poisoned tablets for moles and field mice. Box 25c.

**MOLE-MOTS.** Place in the runs three feet apart. Pkg. 25c.

**MOLOGEN.** A mole killer that will eliminate moles from lawns and gardens. 1/2 lb. 50c.

**NAPHTHALENE FLAKES.** Used for destroying thrips on dry bulbs, also will prevent mice from destroying newly planted bulbs. Lb. 25c, 5 lbs., \$1.00, 25 lbs. \$4.00.

**NICO-FUME LIQUID.** For spraying or fumigating. Does not stain or injure the blooms. Lb. \$2.35, 4 lbs. \$6.00, 8 lbs. \$10.50.

**NICO-FUME PAPER.** Extra strong tobacco paper for burning. 144 sheets \$5.00, 288 sheets \$8.50.

**NICO-FUME POWDER.** Packed in Pressure Fumigator tins. Case of 12 one-pound tins, \$7.50. 6 one-pound tins, \$4.00. One pound, 75c.

**NICOTINE SULPHATE "Black Leaf 40".** For aphids, thrips, etc. 1-oz. bottle 35c, 5 ozs. \$1.00, 2 lbs. \$3.25, 5 lbs. \$6.00.

**NICOTINE PYROX.** A combined poison and foliage spray. 17-oz. jar 50c, 5 lbs. \$2.00.

**PARA-DICHLORO-BENZINE.** The best remedy for Peach tree borers. 1-lb. tin 60c, 5 lbs. \$2.50.

**PARIS GREEN.** For potato bugs, etc. Lb. 60c, 5 lbs. \$2.75.

**POMO-GREEN WITH NICOTINE.** Used as a dust or spray to control both insects and diseases on all plants. 1 lb. 75c, 5 lbs. \$3.00.

**PYRETHRUM POWDER.** Non-poisonous, harmless to leaves or flowers. A sure kill for Mexican Bean Beetle and other insects. 1 lb. 80c, 5 lbs. \$3.50, 25 lbs. \$16.00.

**PYRETHRUM GARDEN SPRAY.** For killing chewing and sucking insects. An extract of pyrethrum combined with spreader. One 1/4 oz. 25c.

**PYROX, PASTE.** Kills all leaf-eating insects and prevents blights and fungous troubles, without injury to fruit or foliage. 25 lbs. \$5.75, 50 lbs. \$8.75, 100 lbs. \$15.50.

**PYROX with NICOTINE.** A combination spray for fungus diseases and chewing insects. 17 oz. jar 50c, 5 lbs. \$2.00.

**RAT NOTS.** Contains Red Squill. Harmless to other animals. Per package 25c.

If Insecticides are wanted by parcel post add postage at zone rates.

INSECTICIDES—Continued

**RED ARROW GARDEN SPRAY.** Contains Pyrethrum and Rotenone. The all round Insecticide for Home Gardeners. Harmless to humans. Deadly to chewing and sucking insects. Does not require soap. 1 oz. 35c, 4 oz. \$1.00, pint \$2.50, qt. \$4.00, gal. \$12.00.

**RED A SOAP.** A liquid neutral Potash Coconut Oil Soap. May be used with any liquid insecticide. Qt. \$1.00, gal. \$2.25.

**RODOPELL.** Protect bulb plantings against ravages of rats, mice, moles and other rodents. It is not a poison but drives them away from the plantings. 3 lbs. (100-bulb size), \$2.00. 7½ lbs. (250-bulb size), \$3.75.

**ROTECIDE DUST. Rotenone Dust.** For dusting vegetables and flowering plants. Lb. 35c, 5 lbs. \$1.50.

**ROTECIDE. Rotenone Spray.** A non-poisonous and very effective insect control. 8 oz. \$1.00, qt. \$3.00, gal. \$8.00.

**SCALECIDE.** For San Jose scale and spraying all kinds of trees. Qt. 75c, 1 gal. can \$1.60, 5 gals. \$6.00, 30 gals. \$21.00, 50 gals. \$29.00.

**SEMESAN.** The well known plant disinfectant for rots, damping off, etc. 2 oz. 60c, 1 lb. \$2.75, 5 lbs. \$13.00.

**SLUG SHOT.** Destroys all insects injurious to garden plants, vegetables and fruits of all kinds. 1 lb. cartons 25c, 5 lb. pkg. \$1.00.

**SNAROL.** A new prepared meal for cutworms, slugs, snails, sow bugs and grasshoppers. Harmless to vegetation. 1-lb. carton 35c, 4 lbs. 85c, 15 lbs. \$3.00, 50 lbs. \$8.00.



**SULPHUR, Powdered.** A staple preventive for mildew on Grapes, Roses, etc. Lb. 20c, 10 lbs. \$1.50, 25 lbs. and over 12c per lb.

**SULFOCIDE.** A summer spray for Peaches and other fruits and mildew on flowers, etc. Gal. \$2.50, 5 gals. \$8.00.

**TEROGEN.** Used for destroying the spores of fungus diseases in the soil. It also acts as a fertilizer and preventive against black spot, aphides and beetles. 1 lb. 75c, 2 lbs. \$1.25, 5 lbs. \$2.75, 10 lbs. \$4.75, 25 lbs. \$11.00, 100 lbs. \$40.00.

**TO-NA-CIDE.** Used as a soil treatment for control of thrips, sow bugs, all worms, etc. Use one pound to 40 square feet of surface. 5 lbs. \$1.75, 25 lbs. \$7.00, 50 lbs. \$11.00, 100 lbs. \$16.00.

**TREE TANGLEFOOT.** A sticky substance applied directly to the bark to protect trees against climbing insect pests. 1 lb. will make a band 7 to 8 feet long. Lb. can 65c, 5 lbs. \$3.00, 10 lbs. \$5.75, 25 lbs. \$12.00.

**TREE WOUND PAINT, Key Brand.** Prevents decay. A penetrating antiseptic paint that is not affected by heat, cold or moisture. Does not peel, crack or get brittle. Stops trees bleeding and prevents decay. Qt. \$1.20, gal. \$3.00, 5 gal. \$13.00.

**TRI-GEN.** A complete insect spray and insecticide. Destroys plant lice and all leaf eating insects, also acts as a fungicide against black spot, rust and mildew. Small kit \$1.50, medium kit \$4.00, large kit \$6.00.

**TOBACCO DUST.** Destroys Rose lice, Cabbage and Turnip fleas, etc. Lb. 15c, 5 lbs. 60c, 10 lbs. \$1.00, 100 lbs. \$4.50.

**TOBACCO STEMS FOR FUMIGATING.** Clean and free from rubbish. In bales of 100 lbs. \$3.50.

**VOLCK, Nursery.** A scientific insecticide for greenhouse and garden use. Effective against scale, mealy bug, red spider, aphides, thrips and flies. Qt. 80c, gal. \$2.50, 5 gals. \$7.50.

**WHALE or FISH OIL SOAP.** Kills lice and sucking insects on trees, shrubs, plants, vines and Roses. Lb. 30c, 5 lbs. \$1.30, 25 lbs. \$5.00.

**WILSON'S O. K. PLANT SPRAY.** A powerful yet harmless and efficient insecticide in concentrated form. Useful for outside and greenhouse spraying. ½ pt. 40c, qt. \$1.00, gal. \$3.00, 5 gals. \$12.00. 10 gals. \$22.00, 25 gals. \$50.00, 50 gals. \$90.00.

**X.-L.-ALL INSECTICIDE.** A well-known English insecticide. Original gallon cans, each \$8.50.

**X.-L.-ALL VAPORIZING COMPOUND.** The most effectual method of fumigating greenhouses. Bottle sufficient for 10,000 cu. ft., No. 3, \$3.00; bottle sufficient for 20,000 cu. ft., No. 2, \$5.00. Fumigators for above, \$2.00 each.

**ZENKE'S FUNGICIDE.** Effective remedy for leaf spot, rust, mildew and black rot. Gal. \$4.00.

Insecticides if wanted by parcel post add postage at zone rates.

INSECT-O-GUN



Attached to your garden hose, the Insect-O-Gun ejects a penetrating wide-angle spray with tremendous velocity, reaching every insect in its path with telling results.

The Insect-O-Gun is equipped with a standard pint mason jar and can be used with any insecticide requiring water solution. No adjustments are necessary to secure the correct spraying proportion, and there are no moving parts except the handy trigger for operating the gun. When full, the gun holds sufficient insecticide to completely treat the average garden.

The Insect-O-Gun is strongly built of heavy, non-rusting die metal and with reasonable care will last a lifetime. Any standard pint mason jar can be used with the unit. It is boxed complete with full instructions, ready to attach to your garden hose for instant use. Pint size for 3 gals. \$3.75. Quart size for 6 gals. \$4.75.

GARDEN HOSE SPRAYER



Can be used with any garden hose for spraying or fertilizing, by placing the cartridges in the nozzle and using the water. Each \$1.00. Cartridge for insecticide 35c, for fungicide 25c. Fertilizer 25 for \$1.00.

AUTOMATIC LAWN-VEX

This simple device makes it possible for you to fertilize your lawn as you sprinkle. The Vex is an enameled brass cylinder 12 in. long and 3 in. diameter. It has two hose connections. One for the faucet, the other for the water to pass out through the hose charged with the lawn fertilizer. The cylinder contains a cartridge of Lawn Vex sufficient for a plot 40 x 60 ft. Vex Container and Cartridge, \$4.85. Extra Cartridges \$1.45 each.

SPRAYIT PLANTILIZER



The new and easy way to fertilize your lawn or garden as you sprinkle with the Sprayit Plantilizer. Just remove the nozzle from the hose and attach the Plantilizer and turn on the water.

Complete with 5 Cartridges, \$1.00. Refill Cartridges, set of 5 for 25c.

"ADCO" ARTIFICIAL MANURE

A simple preparation for making stable manure from garden refuse, grass clippings, weeds, leaves, vegetable tops, etc. It contains nothing injurious to health or animal life is odorless and weed free.

Refuse can be piled in a heap or pit and with "Adco" added to the refuse, causing the bacteria to rot and make manure. Fifty pounds of Adco makes a ton of well rotted manure.

Adco, in 25 lb. bags, enough for 12 wheelbarrows of waste or ½ ton of manure. Each \$2.00.

Adco, in 150 lb. bags, enough to make 3 tons manure. Each \$10.50, f.o.b. Carlisle, Pa.

# INDEX

	Page		Page		Page		Page
Acidanthera	51	Flower Holders	82	Lily Bulbs	62, 63	Scythe Stones	88
Adco	95	Flower Seeds	5-34	Lily-of-the-Valley	53	Seeders	88
Agapanthus	51	Forks	82	Lime, White	86	Semesan	95
Amaryllis	51	Fruit Trees	78, 79	Madeira Vine	53	Shading, Greenhouse	88
Amorphophallus	51	Fruit Picker	82	Marble Dust	86	Shears, Border	88
Anemones	51	Fumigating Materials	94, 95	Mattocks	86	Shears, Grass	88
Angelonia	7	Fumigators	82	Mats, Hotbed	86	Shears, Hedge	88
Antirrhinum	64	Garden Lines	82	Melon Frames	86	Shears, Lopping	87
Aprons, Gardeners	80	Garden Hose Sprayer	95	Melon Nets	86	Shears, Pruning	83
Aquatic Plants	65	Gladiolus	59-61	Milo	3	Sharpener, Tool	88
Areoil Burner	92	Glass Cutters	82	Millet	50	Shovels	88
Asparagus Buncher	80	Glazing Points	82	Mole Traps	86	Shreds, Garden	88
Bamboo Canes	80	Gloriosa	52	Molo	86	Sieves, Wire	88
Bamboo Rake	87	Gloxinias	52	Montbretias	53	Signs	88
Barley	50	Gloves, Gardening	82	Moss, Sphagnum, etc.	86	Silkline	88
Baskets	80	Gooseberries	79	Mulch Paper	86	Smilax Twine	88
Beetle Traps	80	Grafting Wax	82	Multi-Mulch	93	Soil Tester	88
Begonias	51, 64	Grapes	79	Nails, Wall	86	Spades	88
Bellows Powder	80	Grape Bags	82	Nerines	53	Spiraea	73
Berberis	79	Grass Catchers	85	Netting, Bird	86	Sprayers	88, 89, 95
Bessera	8	Grass Edging Knives	84	Novelties	5-8	Sprinklers, Rubber	86
Blackberries	79	Grasses	1-4	Nozzles	86	Sprinklers	90
Blake's Lever Clips	80	Grass Hooks	82	Oats	50	Stakes, Plant	86
Books	Cover Page	Greenhouse Plants	64	Oil Cans	86	Stick, Match	90
Boots, Rubber	87	Hammers	82	Oxalis	53	Strawberries	79
Boxes, Flower	80	Hand Cart	80, 81	Paper Tissue and Wax	86	Styptic	92
Brooders	92	Harrow	82	Peas, Field	50	Sulphur Vaporizer	82
Brooms	80	Hedge Plants	79	Peat, Moss	86	Sweet Peas	22, 34
Brushes, Flower Pot	80	Hedge Trimmer	82, 83	Peat, Orchid and Rotted	86	Syringes	90
Buckwheat	50	Herbs	50	Pelargoniums	64	Tan Bark	90
Bulbs	51-63	Hoes, Garden	83	Pencils, Garden	86	Tarred Felt Discs	90
Bulb Planter	80	Horse Boots	83	Perennial Plants	66-74	Tennis Court Broom	80
Burner, Weed	92	Hose, Garden	83	Picks	86	Tennis Nets	90
Burlap	80	Hose Bands	83	Planet Jr. Tools	86	Tennis Marker	90
Bull Dog Clips	80	Hose Clamps	83	Plant Guards	86	Thermometers	90
Caladiums	51	Hose Couplings	83	Plant Protectors	83	Tigridias	54
Callas	51	Hose Connections	83	Plant Stakes	86	Tin foil	90
Cannas	52	Hose Hydrant Attachment	83	Plant Stake Wire	86	Tomato Supports	87
Carnations	64	Hose Menders	83	Plant Supports	87	Tool Sets	90
Carnation Bands	80	Hose Nozzles	83	Plan-Tie	91	Toothpicks, Wired	90
Carnation Staples	80	Hose, Rubber	83	Plows	87	Torches	90
Carnation Supports	80	Hose Reels	83	Post Hole Digger	87	Trained Fruit Trees	78
Carts, Leaf and Barrel	80	Hose Washers	83	Potatoes	46	Tree Bands	90
Celery Bleachers	81	Hot Bed Heaters	83	Potato Hooks	87	Tree Scrapers	90
Cel-O-Glass	81	Hotkaps	83	Pot Hangers	87	Tree Sprinkler	90
Chlidanthus	51	Humus	93	Poultry Supplies	92	Trees, Fruit	78, 79
Chrysanthemums	75	Hyacinth Stakes	83	Powder Duster	81	Trellis	90
Clovers	4	Hyacinthus	52	Privet	79	Tritoma	54, 74
Corn, Field	50	Hydrangeos	65	Pruners, Tree	87	Trowels, Garden	90
Corn Planter	81	Incubators	92	Pruning Shears	88	Truck and Barrel	80
Cotton Batting	81	Insecticides	94, 95	Pumps, Spray	89	Tuberose	54
Cork Bark	81	Insect-O-Gun	95	Pump, Kinney	87	Tubs, Plant	91
Cow Peas	50	Iris, Japonese	71	Putty Bulbs	87	Turfing Irons	91
Curbing	81	Ismene	53	Raffia	87	Twine	91
Cultivators	81, 86	Kneeling Pads	84	Raffia Tape	87	Vallota	54
Currants	79	Knives, Asparagus	84	Rakes	87	Vases, Flower	91
Cutworm Bands	81	Knives, Budding	84	Rapes	50	Vegetable Seeds	36-50
Dahlias	55-58	Knives, Edging	84	Raspberries	79	Vetches	50
Dandelion Rake	87	Knives, Pruning	84	Rat Killer	92	Vines and Climbers	78
Dibbles	81	Label, Garden	84	Rifles, Emery	87	Vine Guides	91
Dirt Bands	81	Ladies' Tool Sets	90	Rock Plants	66-74	Vyn-Tach Hooks	91
Dog-Away	81	Lawn Edger	84	Roses	8, 76, 77	Water Lilies	65
Dust Guns	81	Lawn Grass	2-5	Rubber Boots	87	Watering Pots	91
Edgers, Grass	84	Lawn Mowers	85	Rustic Baskets	80	Weed Killers	92
Egg Boxes	92	Lawn Mower Sharpener	84	Rye	50	Weeders	91
Farm Seeds	50	Lawn Rollers	84	Sash, Hotbed	83	Wheelbarrows	91
Fertilizers	93	Lawn Seeders	88	Saucers, Pot	82	Wheelbarrow Racks	91
Fertilizer Distributor	82	Lawn Sprinklers	90	Saws, Pruning, etc.	87	Wheat	50
Flats, Greenhouse	82	Lawn Sweepers	84	Saw Files	87	Window Boxes	92
Flower Cutter	82	Lawn Trimmer	84	Scissors, Grape, etc.	88	Wire, stemming	92
Florist's Gum	82	Leafmold	86	Scythes	88	Wire Tie Clips	86
Flower Guard	82	Legume Cultures	92			Zephyranthes	54

## The Marshall Plant Label

A perfect, inexpensive, practical waterproof label. It is made of Acetate of Cellulose, transparent, legible on both sides, flexible, interchangeable and self contained. It has no cementing to come apart, being stitched with waterproof material. Can be used for printed labels or names written on paper and slipped into the transparent holder which is provided with a weatherproof string to attach to the plant or stake.

Doz., 50c; 100 for \$3.00; 1000 for \$25.00, postpaid.

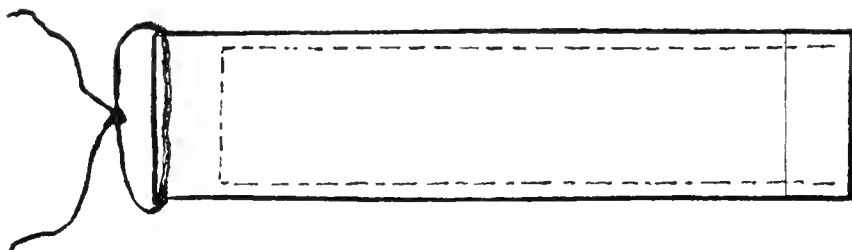





# Garden and Farm Books

A mine of information in each book. Here is a list of standard books written by practical men in language that can easily be understood. Sound, snappy and full of meat. No matter whether you are a beginner or an old hand at the business, you can learn something from these volumes.

## FLOWER SUBJECTS

Annual Flowers. Victor H. Ries.....	\$0.50
Around the Year in the Garden. Rockwell.....	2.50
Book of Annuals. A. C. Hottes.....	1.50
Bulbs, All About Flowering. T. A. Weston.....	2.00
Bulbs, Book of. F. F. Rockwell.....	2.00
Cactus Culture. E. D. Schultz.....	2.00
Carnation Culture, Practical. T. A. Weston.....	2.00
Chrysanthemum and Its Culture. E. A. White.....	2.00
Climbing Plants, Little Book of. A. C. Hottes.....	2.00
Commercial Floriculture. Fritz Bahr.....	5.00
Cyclopedia of Horticulture. In three volumes. New edition. L. H. Bailey.....	15.00
Dahlia Culture. Waite.....	1.50
Dahlia, The. Peacock.....	1.25
Delphiniums. Leon H. Leonian.....	.50
Everybody's Garden. F. A. Waugh.....	3.50
Floriculture, Home. Eben Rexford.....	1.75
Garden Book, The. V. H. Davis.....	1.25
Gardener's Chronicle. The Amateur Gardeners Handbook.....	2.00
Gardener's Chronicle. Monthly. One year.....	2.00
Gardeners and Growers Guide. 4 vols. Audels.....	6.00
Garden Questions, 1001 Answered. Hottes.....	2.00
Garden in the House. H. Van Pelt Wilson.....	.50
Gardener, The. L. H. Bailey.....	2.00
Gladiolus. Rockwell.....	1.25
Gladiolus, The. A. C. Beal.....	1.25
Home Flower Growing. E. C. Volz.....	3.50
Hortus, Dictionary of Gardening. L. H. Bailey.....	5.00
Iris, The. J. C. Wister.....	1.25
Iris. F. F. Rockwell.....	1.25
Lilac Culture. J. C. Wister.....	1.25
Lilies, "Consider the Lilies". W. E. Marshall.....	2.00
Lilies, Garden Cinderellas. Helen M. Fox.....	5.00
Lilies, Garden. I. Preston.....	1.25
Lilies in the Garden. I. Geo. Quint.....	.50
Milady's House Plants. F. E. Palmer.....	1.00
Orchid Culture, American. E. A. White.....	3.00
Perennials, A Book of. A. C. Hottes.....	2.00
Principles of Flower Arrangement. E. A. White.....	3.00
Rose in America, The. J. H. McFarland.....	3.00
Rose Garden Primer. E. Holmes.....	1.75
Roses and Their Culture. S. C. Hubbard.....	1.25
Spring Flowering Bulbs. C. L. Thayer.....	1.25
Spring Flowers from Bulbs. Claire Norton.....	.50
Violet Culture. Coon.....	.75
Wild Flower Families. C. W. Weed.....	.50

## GENERAL LIST OF BOOKS

Color Guide. P. M. Koster.....	\$5.00
Evergreens, Hardy. F. A. Schrepfer.....	1.25
Formal Design in Landscape Architecture. F. A. Waugh.....	3.50
Foundation Planting. L. H. Johnson.....	2.50
Garden Pools. W. Longyear.....	.50
Greenhouses, Their Construction and Equipment. Wright.....	2.00
Landscape Gardening, Practical. R. Cridland.....	2.50
Landscape Gardening. Waugh.....	2.00
Landscapeing the Home Grounds. L. W. Ramsey.....	2.00
Lawn, The. L. S. Dickson.....	1.25
Lawns. F. F. Rockwell.....	1.25
Ornamental Trees, Care of.....	1.25
Plant Culture. G. W. Oliver and Hottes.....	3.50
Plant Propagation. A. C. Hottes.....	2.00
Planning and Planting the Home Garden. P. Murray.....	3.50
Pruning Manual. L. H. Bailey.....	2.50
Pruning, Principles and Practice of. Kains.....	2.50
Rock Garden and Alpine Plants. H. Correvon.....	3.00
Rock Gardening. E. C. Stiles.....	.50
Rock Garden Primer. A. Thornton.....	2.00
Rock Gardens. S. F. Hamblin.....	1.25
Shrubs, The Book of. A. C. Hottes.....	3.00
Shrubs. F. F. Rockwell.....	1.25
Standardized Plant Names. 546 pages.....	5.00
Water Gardening. Peter Bissett.....	3.50
Water Gardens and Goldfish. R. V. Sawyer.....	2.00
Window Garden, The. B. R. Buxton.....	1.50

## FRUITS AND VEGETABLES

Apple Orchard, America. F. A. Waugh.....	\$1.75
Asparagus. F. M. Hexamer.....	1.10
Bean Culture. Glen C. Sevey.....	1.10
Bush Fruit Production. R. A. Van Meter.....	1.25
Cauliflower and Broccoli. A. G. Bouquet.....	1.25
Fruit Growing, Beginner's Guide. F. A. Waugh.....	1.25
Fruits and Vegetables under Glass. W. Turner.....	2.50
Grape Culture. A. S. Fuller.....	2.00
Grape Growing and Wine Making. G. Hussmann.....	2.50
Mushroom Culture. Duggar.....	2.00
Mushrooms, How to Grow. Flaconer.....	1.75
Muskmelon Production. J. W. Lloyd.....	1.25
Ornamental Dwarf Fruit Trees. E. Abjornson.....	1.50
Potato, The. S. Froser.....	1.25
Potato Production. A. L. Nixon.....	1.25
Roadside Marketing. G. Wotts.....	1.25
Starting Early Vegetables and Flowering Plants Under Glass C. H. Nissley.....	3.25
Sweet Potato Production. H. C. Thompson.....	1.25
The Cherry and its Culture. V. R. Gardner.....	1.25
The Pear and its Culture. R. B. Tukey.....	1.25
Tomato Culture. Tracy.....	1.10
Vegetable Forcing. Watts.....	3.00
Vegetable Gardening. R. L. Watts.....	2.50
Vegetables and Berries. A. Kruhm.....	.50

## AUDEL'S GARDEN BOOKS

### Gardeners and Growers Guides

No. 1. Working, Fertilizing, Irrigating and Draining the Soil.....	\$1.50
No. 2. Good Vegetables and Market Gardening.....	1.50
No. 3. Fine Fruit Culture, Cash Crops.....	1.50
No. 4. Beautiful Flowers, Successful Cultivation and Propagation.....	2.00

## ANIMALS, FARM AND POULTRY

Alfalfa. F. D. Coburn.....	\$1.10
Battery Brooding. Milton H. Arndt.....	2.00
Birds of the Wild. Frank C. Pellet.....	1.00
Butter Making. C. A. Publow.....	1.10
Cheese. L. L. Van Slyke and W. V. Price.....	3.25
Corn, The Study of. V. M. Shoemith.....	1.10
Dogs, Our. E. C. Harbison.....	2.50
Ducks and Geese. Lamon & Slocum.....	2.00
Egg Farming. Willard C. Thompson.....	2.00
Farm Animals. Hunt and Burkett.....	1.75
Farmer's Cyclopedia of Agriculture. E. V. Wilson and C. B. Smith.....	4.50
Guide to Sexing Chicks. C. S. Gibbs.....	1.25
Hatchery Management. R. C. Hartman.....	2.75
How to Select the Laying Hen.....	1.25
Judging Farm Animals. C. S. Plumb.....	3.00
Modern Methods of Testing Milk and Milk Products. L. L. Van Slyke.....	2.00
Poultry Breeding and Management. Jas. Dryden.....	2.00
Practical Poultry Farming. L. M. Hurd.....	2.50
Rabbits for Food and Fur. F. G. Ashbrook.....	2.00
Right Use of Lime in Soil Improvement. Alva Agee.....	1.25
Squacs for Profit. W. E. Rice.....	1.10
Swine in America. F. D. Coburn.....	3.50
The Veterinary Adviser. A. S. Alexander.....	1.25
Turkey Production. L. E. Cline.....	3.50
Wine Makers Manual. F. Boswell.....	1.50

## FERTILIZERS, INSECTICIDES AND SOILS

Fertilizers. Gustafson.....	\$1.25
Fertilizers and Crop Production. L. L. Van Slyke.....	4.00
First Principles of Soil Fertility. Alfred Vivian.....	1.40
Insects and their Control. Wilson.....	2.50
Spraying Crops. C. M. Weed.....	1.10
Spraying, Dusting and Fumigating. A. F. Mason.....	3.00

We shall be pleased to supply any books not listed above at advertised prices.

